

TRACON
ELECTRIC®



**TERMÉK
KATALÓGUS**

2021-2022

Tisztelt Partnerünk!

Örömmel nyújtjuk át Önnek a Tracon legújabb katalógusát, mely a korábbi változathoz képest több száz termékkel bővült. Kiadványunkban olyan új cikkek találhatóak a teljesség igénye nélkül, mint az ESPD túlfeszültség levezető sorozat, kompakt megszakító sorozat állítható TM kioldóval, pengés kések, hidegsugor csövek, csavarhúzó szettek, acél kábelkötegelők, műanyag- és fém elosztószekrények, speciális mozgásérzékelők, elektro-hidraulikus présszerszámok, tömítőszelencés kábeltoldók, jelölő- és mérőóra plombák.

Reméljük vevőink gyorsan megkedvelik az új cikkeinket, s a jól megszokott termékeink mellett ezek is hamarosan megjelennek a boltok polcain, s nagy számban kerülnek beépítésre szerte az ország határain innen es túl!

Tracon Budapest Kft.



iOS / Android



- Webáruház és katalógus
- Termék gyorskereső
- Állandó és napi akciók
- Boltkereső térképpel
- Vonalkód és QR kód olvasó
- Naprakész információk



ÚJDONSÁGOK – TERMÉKBŐVÍTÉSEK



**Elektro-hidraulikus
présszerszám B/10**



**Feszítő- és vágószerszám
acél kábelkötegelőhöz B/18**



UTILK pengés kések B/20



Acél kábelkötegelő C/7



**Csavarozható
kábelkötegelő C/8**



**Peremre csíptethető talp,
kábelkötegelővel C/8**



Tépőzáras kábelrendező C/9



**Beüthető
gipszkarton tipli C/14**



Jelölőplomba C/24



Hidegsugor cső D/17



**LED csarnokvilágító
integrált meghajtóval E/14**



**Napelemes utcai LED világi-
tóttest mozgásérzékelővel E/19**



**Hordozható
LED fényvető - profi E/27**



**Napelemes LED fényvető
mozgásérzékelővel E/28**



**Napelemes LED fali világi-
tóttest mozgásérzékelővel E/29**



Autós vészjelző lámpa E/31



**Beepíthető LED panel
SAMSUNG chippel E/36**



LED panel, LPM széria E/41



LED panel, LPH széria E/42



**LED fali világi-
tóttest, SAMSUNG chippel E/45**



Fali lámpatest, ivelt forma E/49



**Design lámpa SKY széria
(csillagfény effekttel) E/51**



**LED fali világi-
tóttest, MFR széria, vezérelhető E/51**



**Falon kívüli LED lámpatest
fokozott védelemmel E/52**



**Védett LED ipari világi-
tóttest por és páramentes E/59**



**Kültéri világi-
tóttestek E/72**



SAMSUNG LED fényforrások E/87



Ipari LED fényforrások E/94



**Üveg LED világi-
tó cső, opál burás E/99**



**Tűlfeszültség levezetők,
ESPD széria F/4**



Ipari csatlakozó dobozok G/27



**Fémajtós
fém elosztószekrény H/15**



**Kompakt megszakító
AKM típus I/2**



**Csúszást csökkentő
jelölőszalag, sárga-fekete M/4**



**Tömítő szelencés
kábeltdő M/10**

VEZETÉKEK KÖTÉSTECHNIKÁJA



SZERSZÁMOK



RÖGZÍTÉSTECHNIKA



ZSUGORANYAGOK



VILÁGÍTÁSTECHNIKA - VILÁGÍTÓ- ÉS LÁMPATESTEK



VILÁGÍTÁSTECHNIKA - FÉNYFORRÁSOK



HÁLÓZATI INSTALLÁCIÓS KÉSZÜLÉKEK



CSATLAKOZÓ ESZKÖZÖK



ELOSZTÓDOBOZOK, ELOSZTÓSZEKRÉNYEK



ENERGIAELOSZTÁS KÉSZÜLÉKEI



RELÉK



IPARI AUTOMATIZÁLÁS ESZKÖZEI



MÉRŐMŰSZEREK



SEGÉDANYAGOK



FÜGGELÉK/MELLÉKLET

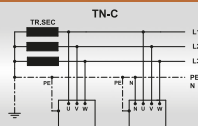



Szigetetlen szemes lemezsaru **2**



Szigetetlen szemes csősaru **4**



Szigetetlen alumínium szemesaru **7**



Szigetetlen réz-alumínium szemesaru **8**



Csavaros saru **8**



Szigetetlen villás lemezsaru **9**



Szigetetlen réz-alumínium toldóhüvely **10**



Szakadófejú toldóhüvely és szemesaru **11**



Szigetelés szigetetlen sarukhoz **13**



Védő- és kontakt paszta **13**



Csavaros kötőelemek kábel-leágazások készítéséhez **13**



Szigetelt szemes saru **14**



Szigetelt villásaru **15**



Szigetelt csapossaru **16**



Hőre zsugorodó hüvely ónnal **17**



Rátolható csatlakozók **18**



Szigetetlen érvéghüvelyek **22**



Szigetelt érvéghüvelyek **23**



Ikerérvéghüvelyek **24**



Csavaros vezetékösszekötők **25**



Késes leágaztatók **25**



Csillárkapocs **26**



Csavar nélküli vezetékösszekötők, nyitható **27**



Csatlakozó napelemhez **28**



Felszálló fővezetési elosztókapocs **28**



Fővezetési leágazó sorkapocs **29**



Főáramköri leágazó kapocs **29**



Főáramköri leágazó kapocs **30**



Fővezetési leágazó sorkapocs nyitható fedéllel **32**



Moduláris elosztóblok nyitható fedéllel **33**



Moduláris toldó kapocs nyitható fedéllel **34**



Flexibilis sorozatkapcsok **35**



TSKD csavarnélküli (rugós) sorozatkapcsok **37**



TSKA ipari sorozatkapcsok **38**



TSKC csavarnélküli (rugós) sorozatkapcsok **42**



Ervéghüvelyprések **2**



Csupaszító és vágószerszámok **3**



Univerzális csupaszító és vágó szerszám **4**



Vágó, csupaszító és prészerszám kommunikációs technikához **4**

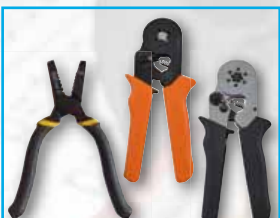

Univerzális ervéghüvelyprés szigetetlen, szigetelt, egyes- és ikerervéghüvelyekhez **5**



Univerzális prészerszám szigetelt kábel-sarukhoz és rátolható csatlakozókhoz **6**



Univerzális prészerszám szigetetlen kábel-sarukhoz **6**



Mechanikus prészerszám szigetetlen kábel-sarukhoz **7**



Univerzális prészerszám szigetetlen rátolható csatlakozókhoz **7**



Kézi működtetésű hidraulikus prészerszám **8**



Akkumulátoros hidraulikus prészerszám **9**



Akkumulátor töltő **9**



Akkumulátor **9**



Elektro-hidraulikus prészerszám bélésekkel, hordtáskában **10**



Elektro-hidraulikus kábelvágó szerszám, hordtáskában **11**



Hidraulikus húzóprés és lyukasztó **12**



Áttételes kábelvágó réz és alumínium kábelekhöz **13**



Kábelvágó szerszám réz és alumínium kábelekhöz **14**

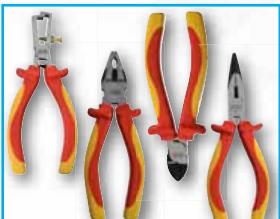

1000 V-ra szigetelt fogók **14**



1000 V-ra szigetelt csavarhúzó, kombiprofil **15**

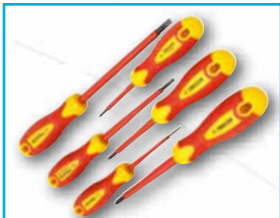

1000 V-ra szigetelt csavarhúzó szett **15**



SD - CrV hegyű csavarhúzók **16**



SD - CrV hegyű csavarhúzók **17**



Kötegfeszítő és vágó kéziszerszám **18**



Feszítő- és vágószerszám acél kábelköteglőhöz **18**



Behúzószálak **18**



Hőlégfúvó **19**



Kétélű csupaszítókés **19**



Kábelcsupaszító szerszám **19**



UTILK pengés kések **20**



BD pengék **21**



Hagyományos kábeltötegelők **2**

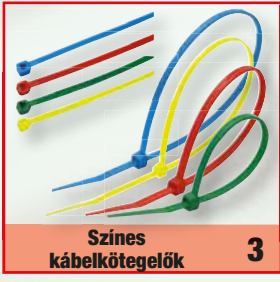

Színes kábeltötegelők **3**



UV-álló fémmelvs kábeltötegelők **4**



Nyitható kábeltötegelők **5**



Gyöngyös nyitható kábeltötegelők **5**



Hőálló kábeltötegelő **6**



Kábeltötegelő égésgátlóval **6**



Benyomótűskés kábeltötegelő **6**



Jelzőcímkés kábeltötegelők **7**



Acél kábeltötegelő **7**



Peremre csiptethető talp, kábeltötegelővel **8**



Tépőzárás kábelrendező **9**



Öntapadás kábeltartó **9**



Csavarozható kábeltötegelő talpak **10**



Normál beüthető kábeltötegelő tiplik **11**



Kábeltötegelő bilincs, szeggel **12**



Műanyag csőbilincs **12**



Kábeltötegelő tiplik **13**



Peremes tiplik, horog és kampó szerelvénnyel **14**



Peremes dübel, hatlapfejű peremes csavarral **14**



Beüthető gipszkarton tiplik **14**



Nagy teherbírásiú nylon tiplik minden anyagba **15**



Gipszkarton tiplik **15**



Beüthető tiplik **16**



Peremes tiplik **17**



Kötélszív **18**



Kampó **19**



U sodronyszorító bilincs **19**



Dupla sodronyszorító bilincs **20**



Rugós karabiner **21**



Kötélfeszítő **22**



Vezetékösszefogó spirál **23**



Önzáró fonott kábeltötegelő **23**



Jelölőplomba **24**



Mérőóra plomba **24**

C
Q

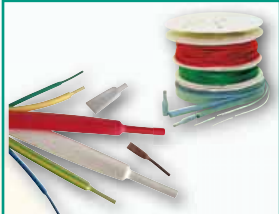

2:1 zsugorodási arányú vékonyfalú zsugorcsovok **2**



3:1 zsugorodási arányú vékonyfalú zsugorcsovok **3**



Közepes- és vastagfalú zsugorcsovok **4**

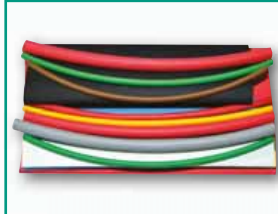

Zsugorcso barkács készlet **4**



Darabolt zsugorcso készletek **5**

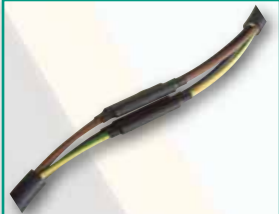

Kisfeszültségű kötészkezetek 0,6/1 kV-os árnyékolatlan kábelekhez **6**



Kisfeszültségű kötészkezetek 0,6/1 kV-os huzalárnyékolású kábelekhez **7**



Kisfeszültségű kötészkezetek 0,6/1 kV-os szalagárnyékolású kábelekhez **8**



Kétágú végelezáró **9**



Háromágú végelezáró **9**



Négyágú végelezáró **10**



Hőlégfúvó **10**



Ötágú végelezáró **11**



Szabadtéri végelezáró készletek 0,6/1 kV-os árnyékolatlan kábelekhez **11**



Végelezáró készletek 0,6/1 kV-os 4-erű huzalárnyékolású kábelekhez **12**



Végelezáró készlet 0,6/1 kV-os 4-erű szalagárnyékolású kábelekhez **13**



Kiöntőgyantás egyenes kötészkezetek **14**



Kiöntőgyantás „Y” kötészkezetek **15**



Záró sapkák **16**



Cipzárás zsugor javító készletek **16**



Hidegzsugor cső **17**

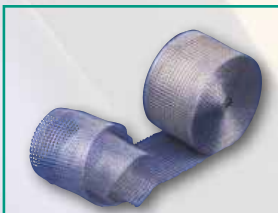

Rézharisnya szalag **18**

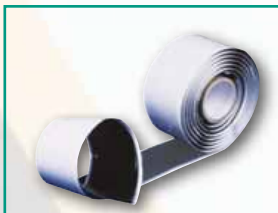

Tömítő szalag **18**



Térkitöltő masszaszalag **18**



Földelő rugó **18**

D



Kültéri LED csarnokvilágítók, LHBP és LHBU széria **13**



LED csarnokvilágító integrált meghajtóval **14**



LED csarnokvilágító, fényerő-szabályozható **15**



Sorolható védett LED ipari világítótest **15**



LED utcai világítóttest, LSJA és LSJB széria (síkfüveggel) **16**



LED utcai világítóttest, LSJR széria **17**



LED utcai világítóttest, LSJK széria **18**



Kiegészítők **18**



Napelemes utcai LED világítóttest mozgásérzékelővel **19**



LED fényvetők, RSMDB széria **20**



LED fényvetők, R-SMDP széria **21**



LED fényvető, szimmetrikus, RHIS széria **22**



LED fényvetők, RSMDL széria **23**



Hordozható / szerelő LED fényvetők **26**



Hordozható LED fényvető - profi **27**



Napelemes LED fényvető mozgásérzékelővel **28**



Napelemes LED fali világítóttest mozgásérzékelővel **29**



LED biciklilámpák **30**



Éjszakai fények **30**



LED fejlámpák **31**



Autós vészjelző lámpa **31**



LED kézi lámpák **32**



LED kézi lámpák **33**



Kerek, beépíthető LED panel **34**



Négyzet alakú, beépíthető LED panel **34**



Inverteres vészvilágító kiegészítő egység LED panelekhez **35**



Kerek, beépíthető LED panel fokozott védelemmel **35**



Kerek, beépíthető LED panel **36**



Négyzet alakú, beépíthető LED panel SAMSUNG chippel **36**



Védett, beépíthető LED mélysugárzó, kerek **37**



Védett, beépíthető LED mélysugárzó, négyzetes **37**



Kompakt beépíthető LED mélysugárzó **38**



LED mélysugárzó változtatható színhőmérséklettel **38**



Süllyesztett lámpatestek spot fényforrásokhoz **39**

...és további
2 oldal



LED mélysugárzó, forgatható 40



LED panel, LPM széria 41



LED panel, LPH széria 42



Meghajtó LPM és LPH panelekhez 42

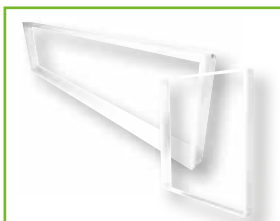

Szerelőkeret LED panelekhez 43

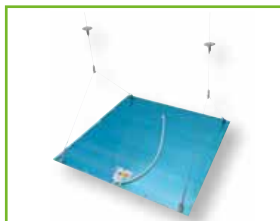

Függesztő készlet LED panelekhez 43



Fényerő-szabályozható meghajtó 43



Rögzítő fül LED panelek súllyesztett szereléséhez 43



Kerek LED falı világitótest, LED-DLF széria 44



Négyzet alakú LED falı világitótest, LED-DLNF széria 44



Kerek LED falı világitótest, LED-DLF széria, SAMSUNG chipel 45



Négyzet alakú LED falı világitótest, LED-DLNF széria 45



Kerek LED falı világitótest, MFDS széria 46



Kerek LED falı világitótest, MFU széria 46



Fényerő-szabályozható LED világitótest 47



Fényerő-szabályozható LED világitótest, függeszthető 47



Kerek LED falı világitótest állítható színhőmérséklettel 48



LUFO fényerő-szabályozható mennyezeti világitótest (3000/4000/5700K) 48



Fali lámpatest, ívelt forma 49



LED falı világitótest, MF széria (csillagfény effekttel) 50



LED falı világitótest, MFS széria 50



Design lámpa SKY széria (csillagfény effekttel) 51



LED falı világitótest, MFR széria (csillagfény effekttel) vezérelhető 51



Műanyag búrás falon kívüli LED lámpatest fokozott védelemmel 52



LED falı világitótest, EVA széria 53



LED falı világitótest, LFEK széria 54



LED falı világitótest, MFM széria (mozgásérzékelővel) 54



Üvegburás falı- és mennyezeti lámpatestek (UFO lámpák) 55



Kézrel nyitható védett falı lámpatest („hajó lámpa”) 55



Védett, műanyag ház as LED hajó lámpa 56



LED hajó lámpa, műanyag ház as 56



Védett LED ipari világitótest 57



Védett LED ipari világitótest 58



Védett LED ipari világitótest por és páramentes 59



Védett lámpatest LED világitó csövekhez 60



Inverteres vészvilágító kiegészítő egységek 60



Védett fénycsőves lámpatestek 61



Elektronikus előtétetek T8-as fénycsővel szerelt lámpatestekhez 61



LED kijáratjelző világítótestek 62



LED-es vészvilágító lámpatest, cserélhető lencsével 62



Vészvilágítók 63



Kiegészítők 63



Védett LED bútorvilágítók, TLFLD sorozat 64



LED bútorvilágítók, TLLED sorozat 64



LED bútorvilágító, műanyag ház 65



LED tükörvilágító lámpa 66



Nyitott lámpatest T8 LED világító csövekhez 67



Normál szerelőlámpák 67



LED asztali világítótestek 68



LED süllyesztett lépcsővilágító, LVS sorozat 70



LED földbe süllyeszthető világítótestek 70



Kültéri LED fali világítótestek, GARC sorozat 71



Kültéri LED fali világítótestek, GLOO sorozat 71



Kültéri világítótestek 72



Alkonykapcsolók 74



PRS.. Jelenlét-érzékelő 75



Speciális mozgásérzékelők 75



Radaros (mikrohullámú) mozgásérzékelők 76



Beltéri infravörös mozgásérzékelők 77



Védett infravörös mozgásérzékelők 78



Fém ház, védett ELG LED meghajtók 80



Dugaszolható tápegységek 81



Sínrre pattintható tápegységek 81



Fém ház LED meghajtók 82



Műanyag ház, védett LED meghajtók 83



Scharfer LED meghajtó 83



Szerelvénydobozba építhető fényerő-szabályzó modulok 84



Vezeték nélküli vezérlőegység-ek világítási áramkörökhez 84



DIN sínrre szerelhető fényerő-szabályzó modulok 85



Kompenzátor 85

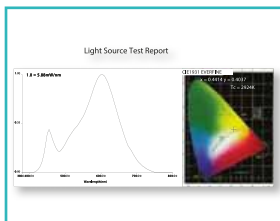

Fénytechnikai laboratórium **2**

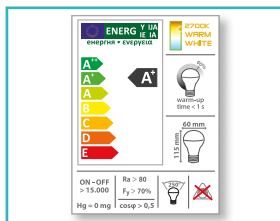

Fényforrások összehasonlító táblázata **3**

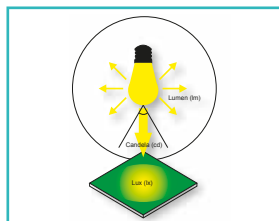

Világítástechnikai alapfogalmak **4**



Normál gömb alakú LED fényforrások Samsung chippel **87**



Gyertya és kis gömb alakú LED fényforrások SAMSUNG chippel **88**



Opál búrás LED spot fényforrások SAMSUNG chippel **89**



Opál búrás LED spot fényforrások **89**



Normál gömb alakú LED fényforrások Samsung chippel **90**



Gyertya alakú LED fényforrások **91**



Kis gömb alakú LED fényforrások **91**



Opál búrás LED spot fényforrások **92**



Reflektor típusú LED fényforrások **92**



3 lépésben fényerő-szabályozható fényforrások **93**



LED fényforrás beépített mozgásérzékelővel **93**



Ipari LED fényforrások **94**



Beépíthető LED világító modul lámpatestekhez **95**



LED fényforrás G9 foglalattal **96**



LED fényforrás G4 foglalattal **97**



Miniatur LED fényforrások E14 foglalattal **97**



LED világító csövek **98**



LED szalagok **101**



LED szalag szettek **102**



Miniatur LED vezérlő **102**



RGB LED vezérlő **103**



Jelerősítő RGB LED szalagokhoz **103**



LED szalag kiegészítők **104**



Alumínium profilok LED szalagokhoz **105**



Végzáró lapok **105**



Rugalmas rögzítő talp **105**



Alumínium profilok (csomag változat) **105**



Fémhalogén fényforrások **106**



Kisméretű halogén izzólámpák **106**



Reflektorlámpák **106**



Fittámp **107**



Fényforrás foglalal **107**





1+2. típusú
túlfeszültség-levezetők **4**



2. típusú
túlfeszültség-levezetők **5**



1+2+3. típusú
túlfeszültség-levezetők **6**



3. típusú
túlfeszültség-levezetők **7**



1+2. és 2. típusú DC
túlfeszültség-levezetők **7**



2+3 típusú túlfeszültség-levezető (LED meghajtóhoz) **11**

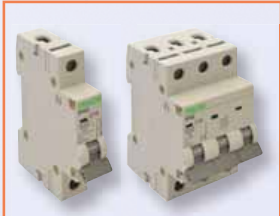

EVOZ kismegszakítók **16**



EVOTDA kismegszakító **17**



EVOH nagyáramú
túlárámvédelmi megszakítók **18**



EVON (1+N pólusú)
kismegszakító **19**



EVOK kombinált
védőkapcsolók **20**



EVOV
áram-védőkapcsolók **21**



EVOTIK
leválasztó kapcsolók **23**



EVOSVK sorolható
váltókapcsolók **24**



EVOMS sorolható, lakatolható
szakaszoló kapcsoló **25**



EVOSLJL jelzőlámpák **25**



EVOP moduláris nyomógomb,
nyomókapcsoló **26**



EVOBT biztonsági (csengő)
transzformátor **26**



EVOHK Installációs
kontaktorok **27**



Feszültségfigyelő relé **28**



MB kismegszakítók **31**



TDZ kismegszakítók **32**



DC kismegszakítók egyenáramú
villamos hálózatokhoz **33**



KVK kombinált áramvédő
kapcsolók **35**



RB áram-védőkapcsolók **36**



Áram-védőkapcsoló, motoros automata
visszkapcsoló készülékkel **39**



Lépcsőházi időkapcsoló **41**



Impulzusrelék **42**



Jelzőcsengők **42**



Sorolható csatlakozóaljzat **43**



Falon kívüli kapcsolók és csatlakozóaljzatok, TR-PH típus **44**



Süllyesztett csatlakozóaljzat
USB porttal **46**



Vezeték nélküli csengő **47**



Szén-monoxid érzékelő **50**



Vezeték nélküli füstérzékelő
átjelzési lehetőséggel **51**

				
Digitális napi kapcsolóóra, moduláris 2	Elektromechanikus kapcsolóóra 2	Dugaszolható kapcsolóórák 3	Csatlakozó aljzat adapter wifi kapcsolóval 5	Távkapcsolós csatlakozóaljzat 5
				
Kábeldobos hosszabbítók 6	UH univerzális hosszabbítók 7	Csatlakozódugó kábel 8	Csatlakozóaljzat adapter 2 db USB porttal, fehér 9	Hordozható elosztósáv kapcsolóval, fehér 9
				
Újravezetékelhető, rögzíthető elosztósávok 10	Többférőhelyes védett elosztósávok 11	Forgatható, elosztósávok kapcsolóval 12	Szerelhető csatlakozódugók és aljzatok 13	Bútor mögé rejthető csatlakozódugók 14
				
Védőérintkezős átalakító csatlakozók 15	Többférőhelyes átalakító csatlakozó 15	Többférőhelyes kombinált átalakító csatlakozók 16	Védőérintkezős hármás, gumi, lengő csatlakozóaljzat 16	Oldalsó védőérintkezős csatlakozódugó és aljzatok 17
				
Védőérintkezős csatlakozódugó és aljzat húzófüllel 17	Ipari csatlakozódugók 18	Fázisfordító ipari csatlakozódugó 19	Csatlakozó lengőaljzatok 20	Felületre szerelhető ipari csatlakozóaljzat reteszelt kapcsolóval 21
				
Felületre szerelhető ipari csatlakozódugók 22	Felületre szerelhető ipari csatlakozóaljzatok 23	Beépíthető egyenes ipari csatlakozóaljzat 24	Beépíthető ferde ipari csatlakozóaljzat 24	Beépíthető oldalsó és csapos védőérintkezős csatlakozóaljzat 25
				
Oldalsó védőérintkezős adapterek 25	Ipari csatlakozó elosztók 26	Ipari csatlakozó dobozok 27	Üres ipari csatlakozó dobozok 30	Kiegészítő termékek 31



Falon kívüli elosztódobozok 2



Süllyesztett elosztódobozok 2



Falon kívüli elosztódoboz, sík ajtóval 3



Süllyesztett elosztódobozok, sík ajtóval 4

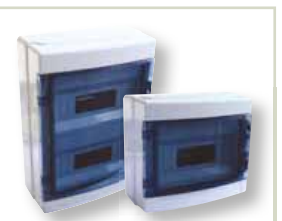

Falon kívüli IP 65-ös elosztódobozok 6



Ajtó nélküli elosztódobozok 6



Ajtó nélküli elosztódobozok, zárpecsételhető 7



Védőburkolat sorolható készülékekhez 7



Műanyag elosztószekrények szerelőlapos ill. maszkos kivitel 8



Falon kívüli fémlemez elosztódobozok 9



Süllyesztett fémlemez elosztódobozok 9



Fémlemez elosztószekrények maszkos kivitelben 10



Esővédő tető fém elosztószekrényekhez 10



Fém elosztószekrények 11



Csapófedeles kezelőablak 12



Fém szekrény szellőzőrács 12



Műanyag biztonsági zárok fém szekrényekhez 13



Tervtartó fém szekrényekhez 13



Kábelbevezető 13



Ívelt biztonsági üvegajtós fém elosztószekrény 14



Fémajtós fém elosztószekrény 15



Szűrőbetétes szellőztető ventilátorok 18



Elosztószekrények kompakt fűtőegységei 19



Kompakt fűtőegységek ventilátorral szerelve 19



Termosztátok (Hőmérséklet-szabályozók) 20



Higrosztát (Légnedvesség-szabályozó) 20

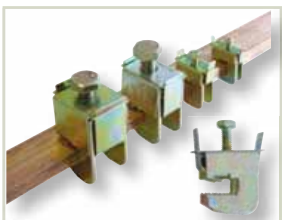

Gyűjtősin leágazó kapcsok 20

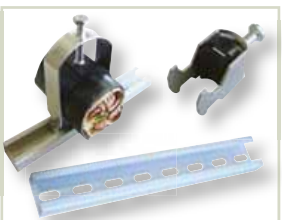

Állítható kábelerősítők 21



Támszigetelők 21



Kompakt megszakító AKM típus, beállítható TM kioldóval **2**



AKM Kézi működtető mechanizmusok (hajtások) **4**



AKM Villamos működtető mechanizmusok (hajtások) **5**



Kompakt megszakítók, KM **6**



Kézi működtető mechanizmusok (hajtások) **8**



Moduláris kompakt megszakítók **10**



Kékes biztosítók **12**



Biztosítóaljzatok **14**

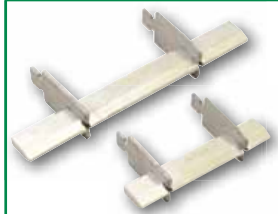

Rövidrezáró kések **15**



Szakaszolókapcsoló-biztosító hengeres biztosítóhoz **16**



Vízszintes szakaszolókapcsoló-biztosítók szerelőlapra **18**



Vízszintes szakaszolókapcsoló-biztosítók, gyűjtősínre szerelhető kivétel **19**



Függőleges szakaszolókapcsoló biztosítók **20**



COSMO 60 mm-es gyűjtősínrendszer **22**



Gyűjtősíntartók és burkolataik (60 mm sinközéptávolság) **22**



Leágázó kapcsok **22**

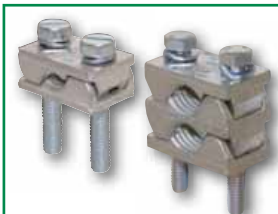

Prizma-kapocs **23**



Ipari kézikapcsolók **24**



Tokozatok **25**

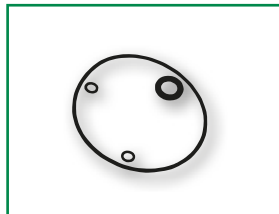

Tömítőkészletek **25**



Szakaszolókapcsoló **33**



Biztonsági szakaszolókapcsoló **34**



Segédkontaktorok **37**



Általános felhasználású kontaktorok **38**



Tokozott motorvédő kapcsoló kombinációk **40**



Nagyáramú kontaktorok **42**



Homlokoldali segédérintkezők **44**



Oldalsó segédérintkező egységek **45**



Időzőegységek **45**

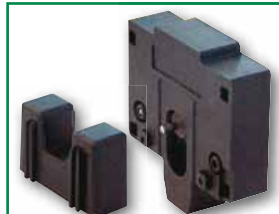

Mechanikus reteszelvek **45**



Termikus túláramvédelmi relék **46**



Kézi működtetésű motorvédőkapcsolók **50**



Homlokoldali segédérintkezők **52**



Munkaáramú kioldók **53**



Tokozatok **53**



Ipari automatizálási relék **2**



Miniatűr relék **3**



Ipari teljesítményrelék **4**



Nagyteljesítményű relék **5**



Miniatűr teljesítményrelék **6**



Print relék **7**



Reléfoglalatok **8**



Egyfunkciós (meghúzás-késleltetési) időrelé **11**



Egyfunkciós (elengedés-késleltetési) időrelé **11**



Elegendéskésleltetési tápfeszültség vezérelt időrelé **12**



Csillag-delta időrelé **12**



Multifunkciós időrelé (10 funkció) **13**



Lépcsőházi időkapcsoló **14**



Feszültségfigyelő relé **15**



Feszültségfigyelő relé 1 fázisra **16**



Feszültségfigyelő relé 3 fázisra **17**



Feszültségfigyelő relé 3 fázisra, beállítható aszimmetriával és túlmegengedés elleni védelemmel **18**



Feszültségfigyelő relé 3 fázisra, nullvezető nélküli hálózatokban **19**



Kompakt feszültségfigyelő relé beállítható időkésleltetéssel **20**



Áramcsökkenés és áramnövekedés elleni védelmi relék **21**



				
LS15 helyzetkapcsolók 2	LS7 helyzetkapcsolók 5	LSME helyzetkapcsolók 8	VP helyzetkapcsolók 12	VT helyzetkapcsolók 16
				
VM helyzetkapcsolók 20	KW helyzetkapcsolók (mikrokapcsolók) 24	Egyszerű nyomógombok 26	Kiálló nyomógomb 26	Világító nyomógomb 27
				
Jelölt nyomógomb 28	Gombafejű nyomógomb 29	Kettős, be-ki nyomógomb 30	Karos kapcsoló 30	Világítókaros kapcsoló 31
				
Kulcsos kapcsoló 31	Érintkező egység NYG(K)3 sorozathoz 32	Tokozat 32	Kiegészítők 34	Feszültség-, árammérők, hangjelzők 35
				
Fényjelző oszlopok 35	LED-es jelzőlámpák 36	Egyszerű nyomógombok 37	Jelölt nyomógombok 38	Kulcsos gombafejű nyomógombok 39
				
Kettős, be-ki nyomógombok 40	Karos kapcsolók 42	Kulcsos kapcsolók 43	Jelzőizzók 44	Érintkezőelemek 44
				
Tokozatok 45	Relés biztonsági kapcsolók 46	TES készülékapcsolók 48	TVTR Egyfázisú elválasztó transzformátorok 52	TVTRB Egyfázisú szigetelő transzformátorok 54

				
Változó áramú feszültségmérő 2	Közvetlen egyenáramú árammérők 3	Változó áramú árammérők közvetett méréshez, cserélhető skálalappal 4	Egyenáramú árammérők közvetett méréshez, cserélhető skálalappal 5	Teljesítménymérők 6
				
Frekvenciamérők 7	Teljesítménytényező (cos φ) mérők 7	Üzemóraszámológok 8	Söntök 8	Sorolható analóg voltmérők 9
				
Sorolható analóg DC alaplmszer sönt méréshez 9	Sorolható analóg frekvenciamérő 10	Sorolható analóg teljesítménytényező-mérők 10	Sorolható digitális mérőműszerek 10	Sorolható analóg teljesítménymérők 11
				
Közvetlen digitális árammérő műszer 12	Digitális teljesítménytényező-mérő 14	Digitális multiméterek 15	Hálózati analízátor 17	Közvetlen fogyasztásmérő 18
				
Áramváltós fogyasztásmérő, 1 fázisú 19	Átfűzős fogyasztásmérő, 1 fázisú 19	Dugaszolható digitális fogyasztásmérő 20	Meddőtéljesítményszabályzó 21	Kisfeszültségű áramváltók 26
				
Hitelesíthető áramváltók 28	Digitális multiméter 30	Digitális lakatfogó 32	Vezeték követő 32	Gépjármű próbálampa 33
				
Fáziskereső csavarhúzó 33	Indukciós ellenőrző készülék 33	Lézerses távolságmérő 33		



				
Szigetelőszalagok 2	Önvulkanizáló, szigetelő szalagok 3	Vászon szigetelő szalag 3	Ipari padlójelölő szalag 3	Maszkolószalag 4
				
Csúszást csökkentő jelölőszalag, sárga-fekete 4	PG tömítőszelencék 5	PG fémből készült tömítőszelencék 5	MG Metrikus tömítőszelencék 6	MG fémből készült metrikus tömítőszelencék 6
				
Metrikus tömítőszelence törésgátló kábelbevezetővel 7	Gégszőhöz illeszkedő kiegészítő gyorscsatlakozó 9	Tömítő szelencés kábeloldó 10	Vezetékjelölők 11	Sorolósínek 125 A-ig 12
				
Szerelősínek 13	Rézsintartó bakok 13	Rézsín (N/PE sín) 13	Szigetelt földelő sín 14	Falon kívüli kötődobozok 15
				
Elektronikai doboz 16	Műanyag doboz 17	Műanyag szerelődobozok 19	Falon kívüli rugalmas kötődobozok 19	Gipszkarton dobozok 19
				
Süllyesztett perforált kötődobozok 20	Süllyesztett perforált szerelvénydobozok 20	Dobozfedelek 21	Univerzális szerelvénydoboz 21	Doboztoldás utólagos szigeteléshez 21
				
Feszítő szerelvények 22	Függesztő szerelvények 22	Csavaros kötőelemek 23	LTT Légzeték-távtartó 23	TB Tetőtartó bevezető 23



VILÁGÍTÁSTECHNIKAI LABORATÓRIUM

- Folyamatos mérések, vizsgálatok
- Ulbricht-gömb, fénytechnikai paraméterek vizsgálata
- EMC-vizsgáló
- Szabványos fényforrás élettartam vizsgálat
- Élettartam vizsgálatok extrém körülmények között

ISO9001

- 1999 óta folyamatosan működő minőség-irányítási rendszer



VILLAMOS ÉS MECHANIKAI LABORATÓRIUM

- Szakítógépes vizsgálat, kötegelők, saruk kötésvizsgálata
- Éghetőségi vizsgálat izzóhuzalos és automata túlángos berendezésekkel
- Műanyag termékek öregedés vizsgálata
- Melegedés mérés
- Átütési szilárdság mérés
- Kismegszakítók, motorvédő-relék idő-áram jelleggörbéjének ellenőrzése
- Klímakamra

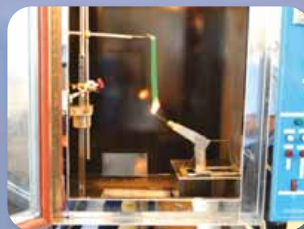

MEGÚJULT WEBÁRUHÁZUNK!

- Új, optimalizált külső
- Boltkereső
- Gyorsabb vásárlási folyamat
- Tudásbázis
- Összehasonlító modul
- Részletes termékkereső
- Mobil optimalizált megjelenítés
- Online fizetési megoldások
- 3D forgatható termékképek
- Részletes termékadatlapok

www.traconelectric.com

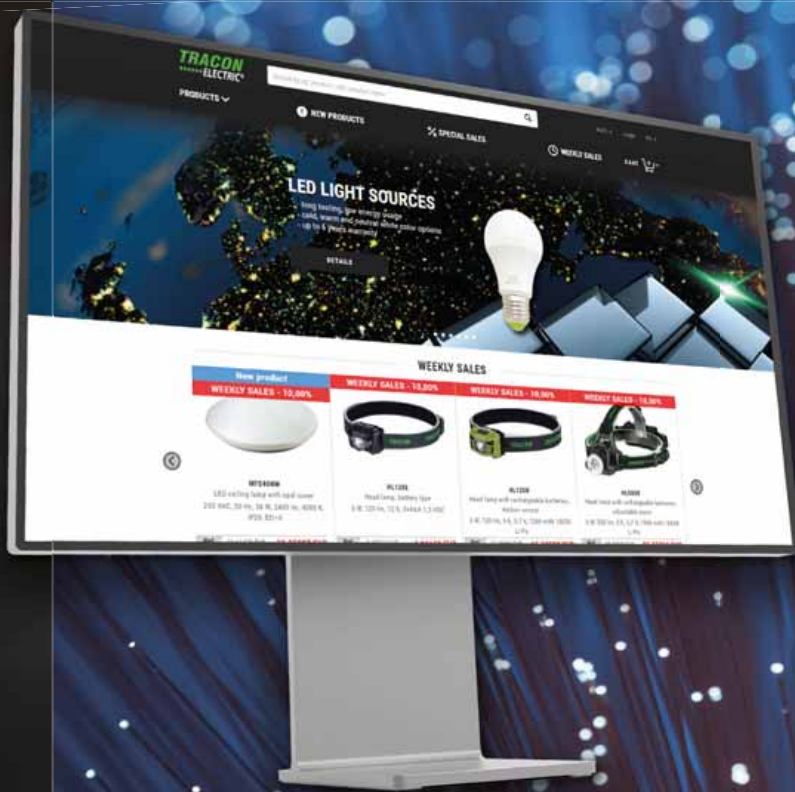

A MÚLT

1990-ben megalakult a Tracon Budapest Kft.



1990

Cégünk az első 10 legnagyobb magyar partner között szerepelt a tajvani kereskedelmi listán



Szlovákiában megalakul az első leányvállalatunk



1999

1992

1994

1995

1996

Megalakul román leányvállalatunk Aradon.



3.500 cikkszám
2.500 m² raktár



1998

TRACON ELECTRIC® 30 ÉVE MAGYARORSZÁGON

ÚJ ÉVEZRED

2003

Megalakul horvátországi leányvállalatunk Varasdon

2004

Megalakul szerb, cseh és szlovén leányvállalatunk

2005

Dunakeszin elkészül 5.000 m²-es új logisztikai központunk



2007

A raktárunkat bővítjük újabb 2.000 m²-rel

2009

Villamos- és fénytechnikai laboratóriumunk bővül EMC vizsgálóval és Ulbricht-gömbbel



Megalakul lengyelországi leányvállalatunk.

2015

Elindul a robotizált okosraktárunk.

2019

Raktárunk újabb 1.800 m²-rel bővült

FORGALOM



8,1 milliárd forint

2020-ban

TERMÉKEINK



-a raktárról azonnal elérhető



7 LEÁNYVÁLLALAT EURÓPÁBAN

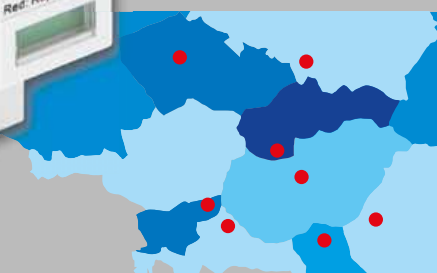

A világ 65 országába exportálunk

MA

OKOSRAKTÁR

11 robotpálya



44.000 tárolórekesz

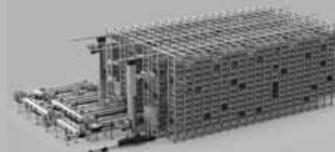

2,4 milliárd forint értékű raktárkészlet

18.000 partner

8.000 cikkszám

11.800m²

logisztikai központ



171 fő közvetlenül foglalkoztatott munkavállaló a cégcsoportban

UTILK
PENGÉS KÉSEK
ÉS PENGÉK



FLEAL
FŐÁRAMKÖRI
LEÁGAZÓ KAPCSOK



TGE
ELOSZTÓ-
SZEKRÉNYEK



EDSS
ELOSZTÓ-
DOBOZOK



NAR
MODULÁRIS
RELÉK



MP
JELŐLŐ- ÉS
MÉRŐPLOMBÁK



NYG3
NYOMÓGOMBOK



F.
ACÉL KÁBEL-
KÖTEGELŐK



NYG3
NYOMÓGOMBOK



F.
ACÉL KÁBEL-
KÖTEGELŐK

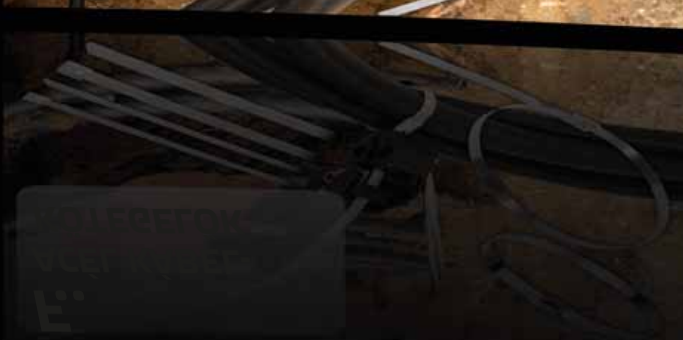

NYG3
NYOMÓGOMBOK





EVO
MODULÁRIS
TERMÉKCSALÁD



ESPD
TÚLFESZÜLTÉS
LEVEZETŐK



AKM
KOMPAKT
MEGSZAKÍTÓ



DK..
HIDRAULIKUS
SZERSZÁMOK



TDB
ELOSZTÓ-
DOBOZOK



MINŐSÉG
ÉS BIZTONSÁG



















SDSETOF
KÉZI SZERSZÁMOK























HZS
HIDEGZSUGOR
CSÖVEK



Táblázat fejlécek piktogramjai

 In Névleges áram (A)	 Un Névleges feszültség (V)	 Megjegyzés, kiegészítés	 m Tömeg
 X Csavarok száma	 M Menet	 Szín	 Ajánlott préserszám
 Félkör profil	 Hatszögletű profil	 Beköthető vezeték keresztmetszet	 \varnothing mm Vezeték átmérő
 X Kapcsok száma	 Betáp oldal	 Leágazó oldal	 Tömör, sodrott, hajlékony vezeték
 \varnothing mm ² Préselési tartomány	 xP Pólusszám	 Ui Névleges szigetelési feszültség	

Műszaki adatok piktogramjai

 Al A kötőelem anyaga: Alumínium	 Cu-sn A kötőelem anyaga: Ózozott réz	 Cu A kötőelem anyaga: Réz ötvözet	 E-Cu-sn A kötőelem anyaga: Ózozott elektrolitréz
 E-Cu A kötőelem anyaga: Elektrolitréz	 PA6.6 A szigetelés anyaga: Poliamid 6.6	 PE A szigetelés anyaga: Polietilén	 POLYOLEFIN A szigetelés anyaga: Poliolefin
 PP A szigetelés anyaga: Polipropilén	 PVC A szigetelés anyaga: PVC	 Ta Környezeti hőmérséklet -55...+95 °C	 Nm 0.4 - 0.8 Meghúzási nyomaték
 Szerelősínre szerelhető 35x7.5mm	 3:1 Zsugorodási arány	 IP 20 Védetség fokozat	 V2 UL94 Lángállóság UL94 szerint
 Ui Névleges szigetelési feszültség 500 V	 Sn A kötőelem anyaga: Ón	 Al-sn A kötőelem anyaga: Ózozott alumínium	 Cu-Ni A kötőelem anyaga: Nikkelezett réz

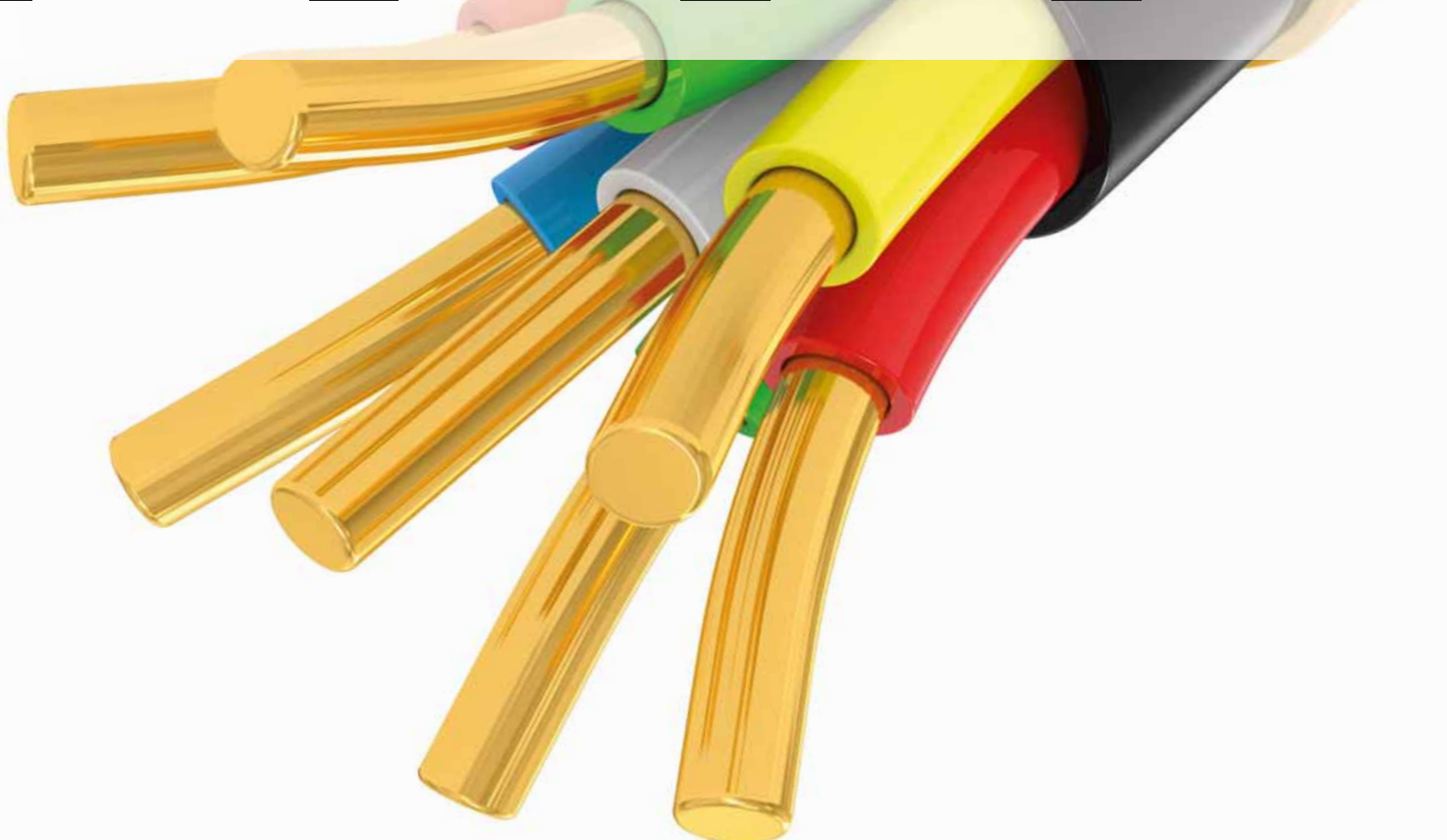



Szigetetlen szemes lemezsaru **2**



Szigetetlen szemes csősaru **4**



Szigetetlen alumínium szemesaru **7**



Szigetetlen réz-alumínium szemesaru **8**



Csavaros saru **8**



Szigetetlen villás lemezsaru **9**



Szigetetlen réz-alumínium toldóhüvely **10**



Szakadófejú toldóhüvely és szemesaru **11**



Szigetelés szigetetlen sarukhoz **13**



Védő- és kontakt paszta **13**



Csavaros kötőelemek kábel-leágazások készítéséhez **13**



Szigetelt szemes saru **14**



Szigetelt villásaru **15**



Szigetelt csapossaru **16**



Hőre zsugorodó hüvely ónnal **17**



Rátolható csatlakozók **18**



Szigetetlen érvéghüvelyek **22**



Szigetelt érvéghüvelyek **23**



Ikerérvéghüvelyek **24**



Csavaros vezetékösszekötők **25**



Késes leágaztatók **25**



Csillárkapocs **26**



Csavar nélküli vezetékösszekötők, nyitható **27**



Csatlakozó napelemhez **28**



Felszálló fővezetési elosztókapocs **28**



Fővezetési leágazó sorkapocs **29**



Főáramköri leágazó kapocs **29**



Főáramköri leágazó kapocs **30**



Fővezetési leágazó sorkapocs nyitható fedéllel **32**



Moduláris elosztóblok nyitható fedéllel **33**



Moduláris toldó kapocs nyitható fedéllel **34**



Flexibilis sorozatkapcsok **35**



TSKD csavarnélküli (rugós) sorozatkapcsok **37**



TSKA ipari sorozatkapcsok **38**



TSKC csavarnélküli (rugós) sorozatkapcsok **42**

Szigeteletlen szemes lemezsaru

TRACON	d ₁ (mm)	d ₂ (mm)	D (mm)	L (mm)	B (mm)	mm ²									
SZ1.5-3	2.3	3.7	4	16	8.4										
SZ1.5-4	2.3	4.3	4	16	8.4										
SZ1.5-5	2.3	5.3	4	16	8.4										
SZ1.5-6	2.3	6.4	4	21.5	11.6	1.5-2.5	1.5-2.5	1-1.5							
SZ1.5-8	2.3	8.4	4	21.5	11.6										
SZ1.5-10	2.3	10.5	4	25.5	13.7										
SZ2.5-4	3	4.3	5	17.8	8										
SZ2.5-5	3	5.3	5	17.8	8										
SZ2.5-6	3	6.4	5	21	12	4-6	2.5-4	2.5-4							
SZ2.5-8	3	8.4	5	27.5	15										
SZ2.5-10	3	10.5	5	27.5	15										
SZ2.5-12	3	13	5	30.8	18.9										
SZ4-4	3.4	4.3	5.5	19	9.6										
SZ4-5	3.4	5.3	5.5	19.6	9.6										
SZ4-6	3.4	6.4	5.5	23	12	4-6	(2.5)4-6	(2.5)4-6							
SZ4-8	3.4	8.4	5.5	27.6	15										
SZ4-10	3.4	10.5	5.5	27.6	15										
SZ10-4	4.5	4.3	7.1	23.8	12										
SZ10-5	4.5	5.3	7.1	23.8	12										
SZ10-6	4.5	6.4	7.1	23.8	12	6-10	(4)6-10	4-6							
SZ10-8	4.5	8.4	7.1	29.7	15										
SZ10-10	4.5	10.5	7.1	29.7	15										
SZ10-12	4.5	13	7.1	32.8	19										
SZ16-5	5.8	5.3	9	28	12										
SZ16-6	5.8	6.4	9	28	12										
SZ16-8	5.8	8.4	9	32.2	16	16-25	10-16	6-10							
SZ16-10	5.8	10.5	9	32.2	16										
SZ16-12	5.8	13	9	40.9	22										
SZ25-5	7.7	5.3	11.5	33.7	16.4										
SZ25-6	7.7	6.4	11.5	33.7	16.4										
SZ25-8	7.7	8.4	11.5	33.7	16.4	25-35	16-25	10-16							
SZ25-10	7.7	10.5	11.5	36.7	17.4										
SZ25-12	7.7	13	11.5	42.6	22										
SZ35-6	9.4	6.4	13.5	42.8	22.1										
SZ35-8	9.4	8.4	13.5	42.8	22.1	50-70	35-50	25-35							
SZ35-10	9.4	10.5	13.5	42.8	22.1										
SZ35-12	9.4	13	13.5	42.8	22.1										

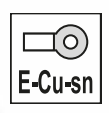
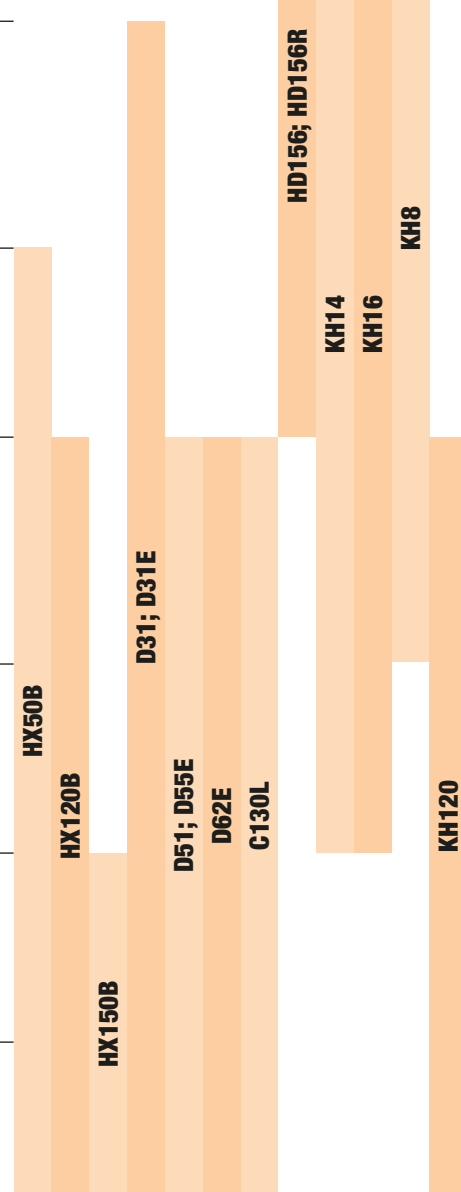





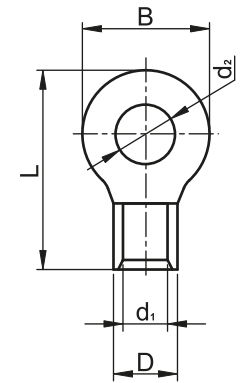

TÜV MEEI TEST DOCUMENTATION
V-07008

RELEVANT STANDARD
MSZ-05-45.1601-1

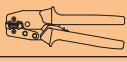
RELEVANT STANDARD
EN 61238-1



Szigeteletlen szemes lemezsaru

TRACON	d ₁ (mm)	d ₂ (mm)	D (mm)	L (mm)	B (mm)	mm ²				
										
SZ50-6	11.4	6.4	15.5	50	22					
SZ50-8	11.4	8.4	15.5	50	22					
SZ50-10	11.4	10.5	15.5	50	22	70-95	50-70	35-50		
SZ50-12	11.4	13	15.5	47.2	22					
SZ50-16	11.4	17	15.5	57.4	32					
SZ70-6	13.3	6.4	17.5	51	24					
SZ70-8	13.3	8.4	17.5	51	24					
SZ70-10	13.3	10.5	17.5	51	24	95-120	70-95	50-70		
SZ70-12	13.3	13	17.5	51	24					
SZ70-16	13.3	17	17.5	60.7	31.8					
SZ95-8	14.5	8.4	19.5	54	27					
SZ95-10	14.5	10.5	19.5	54	27					
SZ95-12	14.5	13	20.5	54	23.8	120-150	95-120	50-70		
SZ95-16	14.5	17	20.5	58	27.8					
SZ120-8	16.4	8.4	22.5	56	28.4					
SZ120-10	16.4	10.5	22.5	56	28.4					
SZ120-12	16.4	13	22.5	55.6	28.4	–	120-150	70-95		
SZ120-16	16.4	17	22.5	69	32					
SZ150-10	19.5	10.5	26.5	65.8	36					
SZ150-12	19.5	13	26.5	65.8	36					
SZ150-16	19.5	17	26.5	65.8	36	–	185	150		
SZ150-20	19.5	21	26.5	80.5	36					
SZ150-24	19.5	25	26.5	80.5	36					
SZ185-10	21	10.5	28.5	68.8	38.4					
SZ185-12	21	13	28.5	68.8	38.4					
SZ185-16	21	17	28.5	68.8	35.8	–	240	150-185		
SZ185-20	21	21	28.5	87	38.8					
SZ185-24	21	25	28.5	87	38.8					
SZ240-10	24	10.5	32.5	71.5	44					
SZ240-12	24	13	32.5	71.5	44					
SZ240-16	24	17	32.5	71.5	44	–	300	185-240		
SZ240-20	24	21	32.5	90.6	44					
SZ240-24	24	25	32.5	90.6	44					



Szigeteletlen szemes csősaru

TRACON	d ₁ (mm)	d ₂ (mm)	D (mm)	L (mm)	B (mm)	mm ²												
CL1.5-3	1.9	3.7	3.4	17	8													
CL1.5-4	1.9	4.3	3.4	17	8	1.5-2.5	1.5	1-1.5										
CL1.5-5	1.9	5.5	3.4	17	8.5													
CL2.5-4	2.4	4.3	3.9	18	8													
CL2.5-5	2.4	5.3	3.9	18	8	2.5-4	2.5	1.5										
CL2.5-6	2.4	6.4	3.9	19	10													
CL4-5	2.8	5.3	4.5	20.5	10													
CL4-6	2.8	6.4	4.5	20.5	10	4-6	4	2.5										
CL6-5	3.8	5.3	5.5	23	10													
CL6-6	3.8	6.4	5.5	23.5	10	10	6	4										
CL6-8	3.8	8.4	5.5	24.5	12.4													
CL10-6	4.4	6.5	6.1	24.5	10.2													
CL10-8	4.4	8.6	6.1	25.5	12.6	10-16	10	6										
CL16-6	5.4	6.4	7.1	30	10.2													
CL16-8	5.4	8.4	7.1	30	12.7	16	16	10										
CL25-6	6.8	6.4	8.8	30	12.6													
CL25-8	6.8	8.4	8.6	30	12.4	25-35	25	16										
CL25-10	6.8	10.5	8.8	31	15													
CL35-6	8.2	6.4	10.5	35	15.3													
CL35-8	8.2	8.4	10.5	35	15.3													
CL35-10	8.2	10.5	10.5	35	15.3	50	35	25										
CL35-12	8.2	13	10.5	36.5	18.6													
CL50-8	9.5	8.4	12.5	43	18													
CL50-10	9.5	10.5	12.5	43	18	70	50	35										
CL50-12	9.5	13	12.5	43	19													
CL70-8	11.2	8.4	14.5	50	23													
CL70-10	11.2	10.5	14.5	50	21	95	70	50										
CL70-12	11.2	13	14.5	50	21													
CL95-10	13.5	10.5	17.2	55	25													
CL95-12	13.5	13	17.2	55	25.5	120	95	70										
CL120-10	14.5	10.5	19.2	60	28													
CL120-12	14.5	13	19.2	60	28	150	120	70-95										
CL120-16	14.5	17	19.2	60	28													
CL150-12	16.5	13	20.8	69	30.5													
CL150-14	16.5	15	20.8	72	30.5	-	150	95										
CL150-16	16.5	17	20.8	75	31													
CL185-12	18	13	23.2	78	35													
CL185-14	18.5	15	23.2	78	35	-	185	120-150										
CL185-16	18	17	23.2	78	35													
CL240-14	21	15	26	90	38.3	-	240	150-185										
CL240-16	20.3	17	26	90	38.3													
CL300-16	23.5	17	30	100	43.5	-	300	185-240										
CL400-16	28.5	17	36.5	115	53	-	400	300										
CL400-20	28.5	21	36.5	115	53	-	400	300										
CL500-16	29.5	17	39	125	56	-	500	300										
CL625-16	34.5	17	44	130	62	-	625	400										







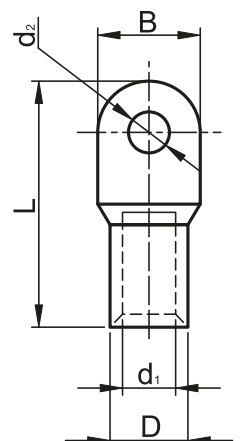

RELEVANT STANDARD
MSZ-05-45.1601-1

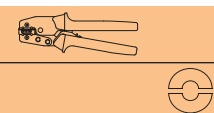
RELEVANT STANDARD
EN 61238-1



Szigeteletlen szemes csősaru, H széria



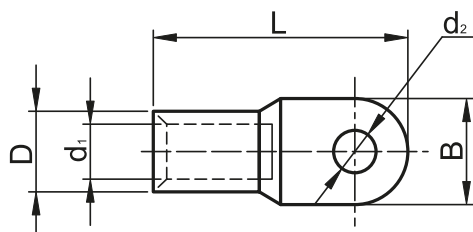

TRACON	d ₁ (mm)	d ₂ (mm)	D (mm)	L (mm)	B (mm)	mm ²				
										
CLH1.5-3	1.8	3.4	3.7	19.5	8	1.5	1.5	1-1.5		
CLH1.5-4	1.8	4.4	3.7	19.5	8	1.5	1.5	1-1.5		
CLH1.5-5	1.8	5.4	3.7	19.5	8	1.5	1.5	1-1.5		
CLH2.5-4	2.5	4.4	4.4	21.5	10	2.5-4	2.5	1.5-2.5		
CLH2.5-5	2.5	5.4	4.4	21.5	10	2.5-4	2.5	1.5-2.5		
CLH2.5-6	2.5	6.4	4.4	21.5	10	2.5-4	2.5	1.5-2.5		
CLH4-5	2.5	5.4	4.4	23.5	10	4	2.5-4	2.5		
CLH4-6	2.5	6.4	4.4	23.5	10	4	2.5-4	2.5		
CLH6-5	4.4	5.4	6	32	8.6	10	6	4		
CLH6-6	4.4	6.4	6	32	8.6	10	6	4		
CLH6-8	4.4	8.4	6	32	8.6	10	6	4		
CLH10-6	6	6.4	8	38.5	11.3	10-16	10	6		
CLH10-8	6	8.4	8	38.5	11.3	10-16	10	6		
CLH16-6	6.8	6.4	9	42	13	16	16	10		
CLH16-8	6.8	8.4	9	42	13	16	16	10		
CLH25-6	7.8	6.4	10	46	14.4	25-35	25	16		
CLH25-8	7.8	8.4	10	46	14.4	25-35	25	16		
CLH25-10	7.8	10.5	10	46	14.4	25-35	25	16		
CLH35-6	8.8	6.4	11	52	16.4	50	35	25		
CLH35-8	8.8	8.4	11	52	16.4	50	35	25		
CLH35-10	8.8	10.5	11	52	16.4	50	35	25		
CLH35-12	8.8	12.5	11	52	16.4	50	35	25		
CLH50-8	10.8	8.4	13	54.5	19.3	50	35	25		
CLH50-10	10.8	10.5	13	54.5	19.3	50	35	25		
CLH50-12	10.8	12.5	13	54.5	19.3	50	35	25		
CLH70-8	12.6	8.4	15	61	21.8	95	70	50		
CLH70-10	12.6	10.5	15	61	21.8	95	70	50		
CLH70-12	12.6	12.5	15	61	21.8	95	70	50		
CLH95-10	15.2	10.5	18	65.5	26.5	120	95	70		
CLH95-12	15.2	12.5	18	65.5	26.5	120	95	70		
CLH120-10	16	10.5	19	72	27.8	150	120	70-95		
CLH120-12	15	12.5	19	72	27.8	150	120	70-95		
CLH120-14	16	14.5	19	72	27.8	150	120	70-95		
CLH120-16	16	16.5	19	72	27.8	150	120	70-95		
CLH150-12	17	12.5	21	80	30.6	-	150	95		
CLH150-14	17	14.5	21	80	30.6	-	150	95		
CLH150-16	17	16.5	21	80	30.6	-	150	95		
CLH185-12	19.4	12.5	24	85	35.2	-	185	120-150		
CLH185-14	19.4	14.5	24	85	35.2	-	185	120-150		
CLH185-16	19.4	16.5	24	85	38.2	-	185	120-150		
CLH240-14	21.4	14.5	26	95	38	-	240	150-185		
CLH240-16	21.4	16.5	26	95	38	-	240	150-185		



RELEVANT STANDARD
EN 61238-1



Szigeteletlen hosszított réz szemes csősaru elektrolitrézből





TRACON	d ₁ (mm)	d ₂ (mm)	D (mm)	L (mm)	I (mm)	B (mm)	mm ²			
										
SZ-CL10	6	8.5	10	68.5	31	16	16	10	6	D31; D31E D51; D55E D62E; C130L KH120
SZ-CL16	5.8	8.5	10	65	32	16	25	16	10	
SZ-CL25	7.5	8.5	11	70	35	18	35	25	16	
SZ-CL35	8.7	10.5	12	80	38	20	50	35	25	
SZ-CL50	10	10.5	14	85	42	23	70	50	25	
SZ-CL70	12	12.5	16	95	47	26	95	70	50	
SZ-CL95	14	12.5	18	103	48	28	120	95	70	
SZ-CL120	15.5	14.5	20	111	52	30	150	120	70-95	
SZ-CL150	17	14.5	22	121	56	34	-	150	120	
SZ-CL185	19	16.5	25	125	59	38	-	185	120-150	
SZ-CL240	21.5	16.5	27	135	60	40	-	240	150-185	

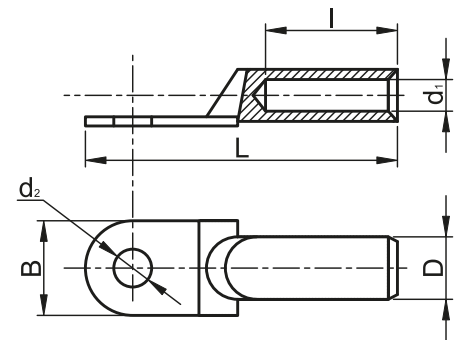

RELEVANT STANDARD
EN 61238-1



Szigeteletlen hosszított réz szemes csősaru, ónozott



TRACON	d ₁ (mm)	d ₂ (mm)	D (mm)	L (mm)	I (mm)	B (mm)	mm ²			
										
SZ-CLSN10	5.8	8.5	9	63	30	16	16	10	6	D31; D31E D51; D55E D62E; C130L KH120
SZ-CLSN16	6,5	8.5	10	65	32	16	25	16	10	
SZ-CLSN25	7,5	8.5	11	70	35	18	35	25	16	
SZ-CLSN35	8,7	10.5	12	80	38	20	50	35	25	
SZ-CLSN50	10	10.5	14	85	42	23	70	50	35	
SZ-CLSN70	12	12.5	16	95	47	26	95	70	50	
SZ-CLSN95	14	12,5	18	103	48	28	120	95	70	
SZ-CLSN120	15,5	14,5	20	111	52	30	150	120	70-95	
SZ-CLSN150	17	14,5	22	121	56	34	-	150	120	
SZ-CLSN185	19	16,5	25	125	59	38	-	185	120-150	
SZ-CLSN240	21,5	16,5	27	135	60	40	-	240	150-185	

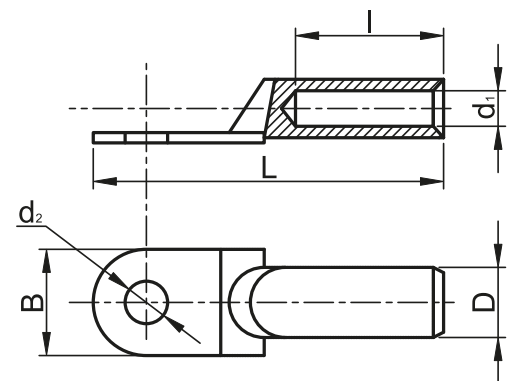

RELEVANT STANDARD
EN 61238-1



Szigeteletlen alumínium szemessaru

TRACON	d ₁ (mm)	d ₂ (mm)	D (mm)	L (mm)	I (mm)	B (mm)	mm ²		
									
AS16-6	5.5	6.4	8.5	65	32	13	25	16	D51; D55E
AS16-8	5.5	8.4	8.5	69	32	13	25	16	
AS25-6	7	6.4	10	68	32	14	35	25	
AS25-8	7	8.4	10	72	32	16	35	25	
AS25-10	7	10.5	10	74	32	17	35	25	
AS35-6	8.5	6.4	12.5	59	32	15	50	35	
AS35-8	8.5	8.4	14	85	42	20	50	35	
AS35-10	8.5	10.5	12.5	80	32	19	50	35	
AS35-12	8.5	13	12.5	81	32	21	50	35	
AS50-8	10	8.4	14.5	91	45	20	70	50	
AS50-10	10	10.5	14.5	94	45	22	70	50	
AS50-12	10	13	14.5	95	45	24	70	50	
AS70-8	11.5	8.4	16.5	95	45	24	95	70	
AS70-10	11.5	10.5	16.5	98	45	24	95	70	
AS70-12	11.5	13	16.5	100	45	24	95	70	
AS95-10	13.5	10.5	19	112	56	28	120	95/120	
AS95-12	13.5	13	19	113	56	28	120	95/120	
AS120-10	15.5	10.5	21	119	56	32	150	120/150	
AS120-12	15.5	13	21	121	56	32	150	120/150	
AS120-14	15.5	15	21	98	56	32	150	120/150	
AS120-16	15.5	17	21	125	56	32	150	120/150	
AS150-10	17	10.5	23.5	130	56	34	185	150	
AS150-12	17	13	23.5	132	56	34	185	150	
AS150-14	17	15	23.5	109	56	34	185	150	
AS150-16	17	17	23.5	136	56	34	185	150	
AS185-10	19	10.5	25.5	136	64	37	240	185	
AS185-12	19	13	25.5	137	64	37	240	185	
AS185-14	19	15	25.5	115	64	37	240	185	
AS185-16	19	17	25.5	142	64	37	240	185	
AS240-12	21.5	13	29	151	64	42	300	240	
AS240-14	21.5	15	29	130	64	42	300	240	
AS240-16	21.5	17	29	156	64	42	300	240	

D51; D55E

D62E

C130L

HD156; HD156R

KH14

KH16

KH8

KH120

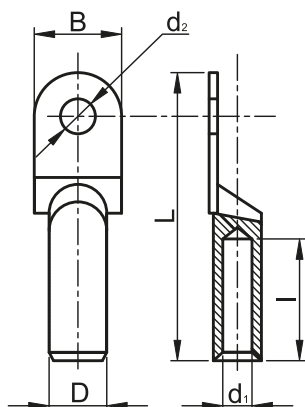

TÜV MEEI TEST DOCUMENTATION
V-09444



RELEVANT STANDARD
EN 61238-1

RELEVANT STANDARD
MSZ-05-45.1601-1

RELEVANT STANDARD
MSZ-05-45.1601-22

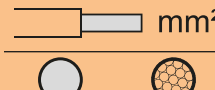

Szigeteletlen réz-alumínium szemessaru

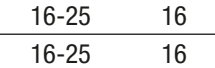
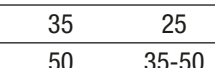
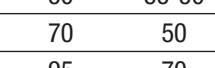
TRACON	d ₁ (mm)	d ₂ (mm)	D (mm)	L (mm)	l (mm)	B (mm)	 mm ²			
RA16-6	5.8	6.5	10.3	69	32	16	16-25	16		
RA16-8	5.8	8.5	10.3	69	32	16	16-25	16		
RA25-8	7.5	8.5	12	76	32	18	35	25		
RA35-8	8.5	8.8	14.3	85	37.5	20	50	35-50		
RA50-10	9.5	10.5	16	91	41	23	70	50		
RA70-12	11.5	12.5	18	101	43.5	26	95	70		
RA95-12	13.5	12.5	20	107	46.5	28	120	95-120		
RA120-14	15.5	14.5	23	118	53	30	150	120-150		
RA150-14	16.5	14.5	24	125	55	34	185	150		
RA185-16	18.5	17	27	133	60	37	240	185		
RA240-16	21	16.5	30	139	60	40	300	240		

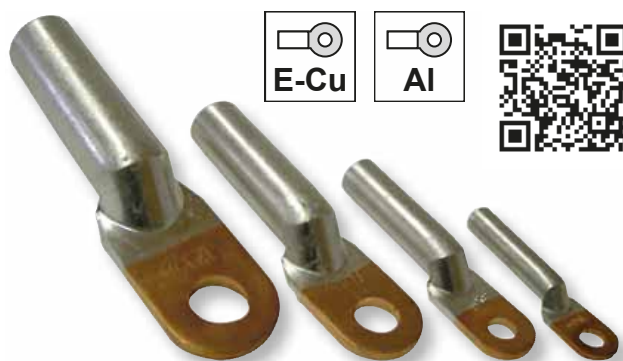



RELEVANT STANDARD
EN 61238-1

RELEVANT STANDARD
MSZ-05-45.1601-1

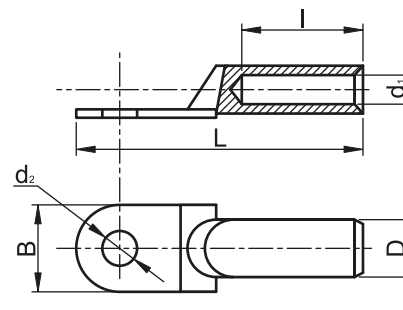
RELEVANT STANDARD
MSZ-05-45.1601-22



Csavaros saru

TRACON	a (mm)	b (mm)	d ₂ (mm)	L (mm)	l ₁ (mm)	B (mm)	W (mm)	X 	 mm ²
WCJB-16-25-2	4	6	8.5	45.3	22	18	22.5	4 × M5 × 20	16-25
WCJB-25-35	4	7	10.5	52.5	25	21.5	24.5	4 × M5 × 22	25-35
WCJB-50-70	5	10	10.5	61	26	23	31	4 × M6 × 24	50-70
WCJB-70-95	5.5	11.5	10.5	69	32	23.5	35	4 × M6 × 30	70-95
WCJB-95-120	5.5	13	13.5	74	28.5	28.5	42	4 × M8 × 35	95-120
WCJB-120-150	5.5	13	13.5	74	30	27	41	4 × M8 × 35	120-150
WCJB-150-185	6.5	13	13.5	76.5	31	28	42.5	4 × M8 × 35	150-180
WCJB-185-240	6.5	14	13.5	80.3	32.5	30	44	4 × M8 × 35	185-240
WCJC-16	3	4.5	8	37	22.5	16	21.5	2 × M5 × 20	16
WCJC-25-35	5	8.5	11	47.5	27.5	22	22	2 × M5 × 23	25-35
WCJC-50-70	6	9.5	11	60.5	31	23	30	4 × M6 × 24	50-70
WCJC-70-95	7	12	13	66.5	35	27	33	4 × M6 × 29	70-95
WCJC-120-150	7	12.5	15	72.5	42	32	32	4 × M6 × 29	120-150
WCJC-185-240	14	19	18	90	46	39	45	4 × M8 × 40	185-240
WCJC-300	14.5	23	21	106	54	45.5	55.5	4 × M10 × 48	300
WCJC-400	19.5	25.5	22.3	122	63	50	59.5	4 × M10 × 52	400





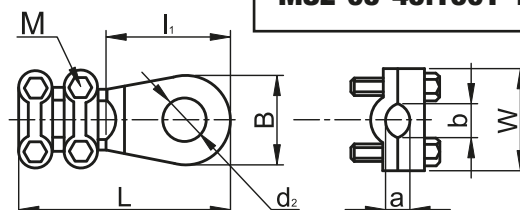

E-Cu-sn

RELEVANT STANDARD
MSZ-05-45.1601-12

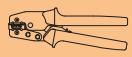

Szigeteletlen villás lemezsaru

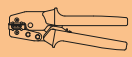
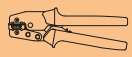
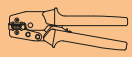
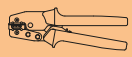
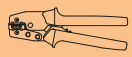
TRACON	d ₁ (mm)	d ₂ (mm)	D (mm)	L (mm)	I (mm)	B (mm)	mm ²				
											
V1.5-3	1.7	3.7	3.4	15.5	6.5	5.7					
V1.5-4	1.7	4.3	3.4	15.5	6.7	7.2	1.5	1-1.5	0.5-1		
V1.5-5	1.7	5.3	3.4	15.5	7.8	6.4					
V1.5-6	1.7	6.4	3.4	15.5	8.9	8.1					
V2.5-3	2.3	3.7	4.1	16	6.9	6	2.5-4	2.5	1.5		
V2.5-4	2.3	4.3	4.1	16	7.3	7.2					
V2.5-5	2.3	5.3	4.1	16	7.7	8.1					
V2.5-6	2.3	6.4	4.1	16	8.8	9.5					
V4-3	3.4	3.7	5.6	19.5	6.7	8.3	4	4-6	6		
V4-4	3.4	4.3	5.6	19.5	7	8.3					
V4-5	3.4	5.3	5.6	19.5	7.5	9					
V4-6	3.4	6.4	5.6	19.5	10.3	12					
V10-4	4.5	4.3	7.2	23	8.3	8.7	10-16	10	6		
V10-5	4.5	5.3	7.2	24.5	8.7	12					
V10-6	4.5	6.4	7.2	24.5	9.4	12					
V16-5	5.8	5.3	9	28	9.7	12	25	16	10		
V16-6	5.8	6.4	9	28	9.8	14					

HD156; HD156R

KH14

KH16

KH8



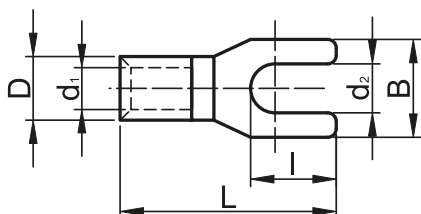

HX50B; HX120B; D31; D31E

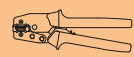

RELEVANT STANDARD

MSZ-05-45.1601-1
MSZ-05-45.1601-22

Szigeteletlen csapos saru

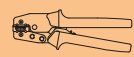
TRACON	d ₁ (mm)	D (mm)	L (mm)	I (mm)	B (mm)	mm ²			
									
CS1.5	1.7	3.2	16.7	11.5	1.7	1.5-2.5	1.5	1-1.5	
CS2.5	2.3	3.8	16.7	11.5	2	2.5-4	2.5	1.5	
CS4	3.4	5.5	20	12.5	2.6	6	4-6	4	

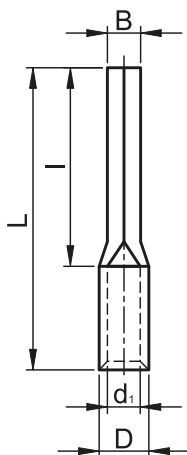
HD156; HD156R;
KH8; KH14; KH16

OLVASSA BE A KÓDOT!

- Nézze meg újdonságainkat
- Legyen naprakész

Kínálatunk gyorsan és folyamatosan fejlődik!
Katalógusunk a 2021. áprilisi állapotot tükrözi.Naprakész információért
látogasson el honlapunkra!

Szigeteletlen toldóhüvely

TRACON	d ₁ (mm)	D (mm)	L (mm)	mm ²				
TH1.5	1.9	3.5	12	1.5-2.5	1.5-2.5	1-1.5		
TH2.5	2.4	3.9	13	4	4	1.5		
TH4	2.8	4.5	15	4-6	4-6	2.5		
TH6	3.8	5.5	15	6-10	6-10	4		
TH10	4.5	6.1	15	10-16	10-16	6		
TH16	5.4	7.1	21	16-25	16-25	10		
TH25	6.8	8.7	26	25-35	25-35	16		
TH35	8.2	10.5	29	50	50	25		
TH50	9.5	12.4	32	70	70	35		
TH70	11.2	14.7	36	95	95	50		
TH95	13.5	17.4	37	120	120	70		
TH120	15	19.4	38	150	150	70/95		
TH150	16.5	21.2	38	-	-	95		
TH185	18.5	23.5	54	-	-	120		
TH240	21	26.5	72	-	-	150-185		

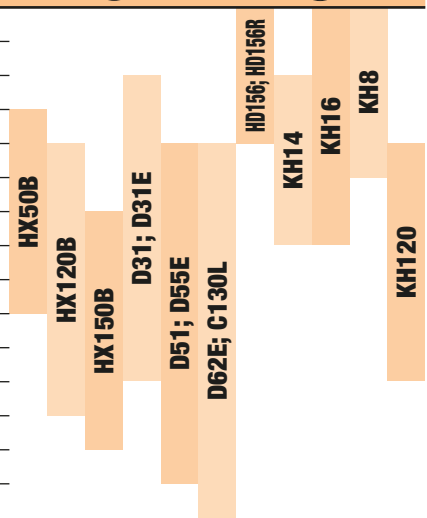

RELEVANT STANDARD
MSZ-05-45.1601-1
EN 61238-1

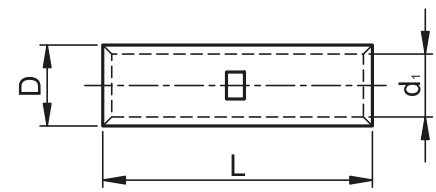

Szigeteletlen réz-alumínium toldóhüvely



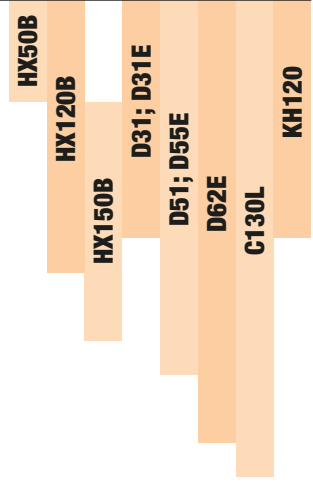



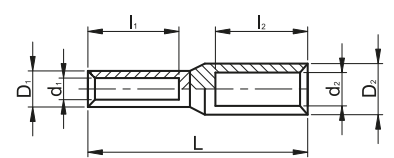
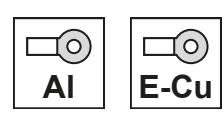



TRACON	d ₁ /d ₂ (mm)	D ₁ /D ₂ (mm)	L (mm)	l ₁ /l ₂ (mm)	mm ²					
RT16/25	6/6.7	10/12.1	75	26.5/32	16	10	6	25	16	
RT16/70	5.5/11	12/17.5	90.5	29.5/45	16	10	6	70	50	
RT25/35	7.3/8	11.6/13.1	83.5	30/40	25	16	10	35	25	
RT35/50	8.5/10	13.3/15.3	95.6	32/42	35	25	16	50	35-50	
RT35/70	8.5/11	12/17.5	90	30/45	35	25	16	70	50	
RT50/70	9.5/11.5	14.6/18	104.5	38/50	50	35	25	70	50	
RT70/95	11.5/13.5	17/21.5	111	40/50	70	50	35	95	70	
RT95/120	12.6/15	19/23.2	110	42/55	95	70	50	120	95-120	
RT95/150	13.5/16.5	19/24.8	116	42/55	95	70	50	150	120-150	
RT120/150	15/17	19/24	118	44/55	120	95	70	150	120-150	
RT150/185	16.6/18	22.5/25.2	125	46/60	-	120	95	185	150-185	
RT185/240	18.5/21	26/30	130	54/60	-	150	120	240	185	
RT185/300	18.5/23	26/34	136	54/65	-	150	120	300	240	
RT240/300	21/23	28/34	145	56/65	-	185	120-150	300	240	



RELEVANT STANDARD
EN 61238-1
MSZ-05-45.1601-1
MSZ-05-45.1601-21



Szigeteletlen alumínium toldóhüvely

TRACON	d_1 (mm)	D (mm)	L (mm)	I (mm)	mm ²		
							
AT16	5.8	10	70	34.5	25	16	       
AT25	7.4	12.1	75	36.7	35	25	
AT35	9.1	14.1	84.5	41.5	50	35	
AT50	9.5	16.1	94.5	46.4	70	50	
AT70	12.2	18	105	51	95	70	
AT95	13.2	21	110	53	120	95-120	
AT120	15.2	23.2	115	55.5	150	120-150	
AT150	16.4	25.5	120	58	185	150	
AT185	19	27.6	122	58	240	185	
AT240	20	30.2	130	63	300	240	



RELEVANT STANDARD
EN 61238-1
MSZ-05-45.1601-1
MSZ-05-45.1601-21

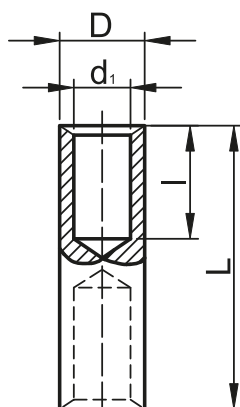

Szakadófejű csavaros alumínium toldóhüvely

TRACON	mm ²	d_1 (mm)	D (mm)	L (mm)	X 
AT16-70CS	16 – 70	13.2	24	71.5	(1+1) × M10
AT95-150CS	95 – 150	28.5	27	107	(2+2) × M12
AT185-240CS	185 – 240	20	33.5	125.5	(2+2) × M14



AT16-70CS



AT95-150CS

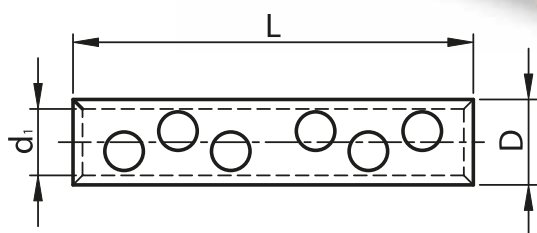

AT185-240CS



RELEVANT STANDARD
MSZ-05-45.1601-1



Szakadófejű csavaros alumínium szemessaru

TRACON	 mm ²	d ₁ (mm)	d ₂ (mm)	D (mm)	L (mm)	B (mm)	X 
AS16-70CS12	B: 16 - 35	11	13	23	90	25	2 × M12
	A: 50 - 70						2 × M12
AS185-240CS16	B: 185	20	17	35	115	38	3 × M16
	A: 240						3 × M16



AS185-240CS16

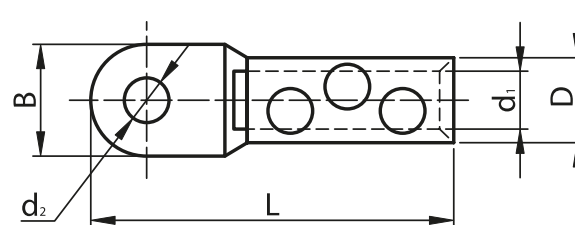

RELEVANT STANDARD
MSZ-05-45.1601-1



 Piktogramok **A/0**

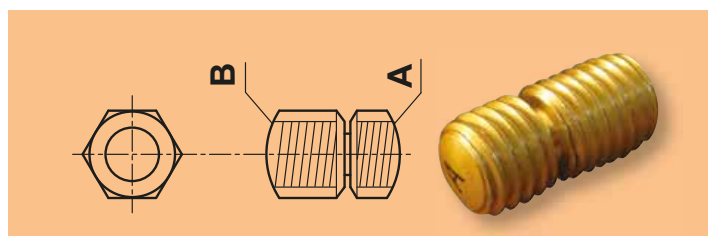

AS16-70CS12



Szakadófejű csavaros réz-alumínium szemessaru

TRACON	 mm ²	d ₁ (mm)	d ₂ (mm)	D (mm)	L (mm)	B (mm)	X 
RA16-70CS12	B: 16 - 35	11	13	23	104	25	2 × M12
	A: 50 - 70						2 × M12
RA95-150CS12	B: 95 - 120	16	13	30	110	30	2 × M12
	A: 150						2 × M12
RA185-240CS16	B: 185	20	17	35	115	38	3 × M16
	A: 240						3 × M16



RA16-70CS12

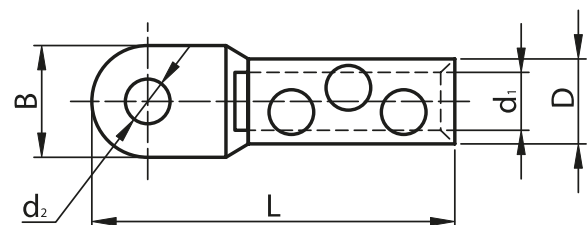

RELEVANT STANDARD
MSZ-05-45.1601-1

 Piktogramok **A/0**



RA95-150CS12

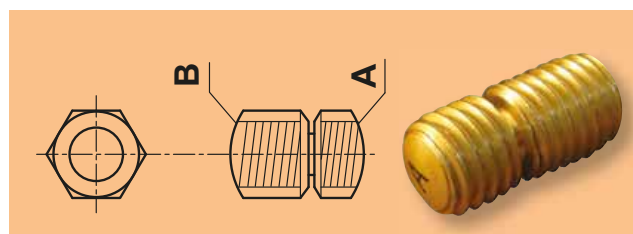

RA185-240CS16

Szigetelés szigeteletlen sarukhoz

TRACON	d_1 (mm)	D (mm)	L (mm)	 mm ²
FSZIG10	6	9.4	21.5	10
FSZIG16	8.1	11.4	28.3	16
FSZIG25	9.8	13.1	30.1	25
FSZIG35	11	14.4	34.7	35
FSZIG50	13.8	17.2	43.7	50
FSZIG95	15.8	19.3	47.5	95
FSZIG120	17.6	21.2	56.6	120

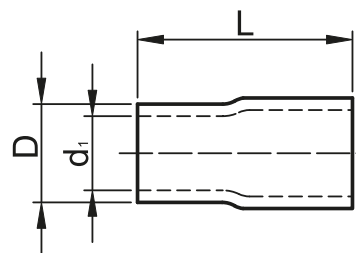

RELEVANT STANDARD
IEC 60684-1



Védő- és kontakt paszta

TRACON	
VKP	150 g

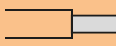

A keveréket a villamos kötéseknel az érintkező felületek közötti oxid-képződés és a korrózió gátlására fejlesztették ki. A keverék minden esetben alkalmazható Al – Al, Al – Cu és Cu – Cu kötések érintkező felületein, összenyomás (préselés), csavaros megszorítás vagy szegecselés előtt.

Csavaros kötőelemek kábel-leágazások készítéséhez

TRACON	 mm ²	H (mm)	C (mm)	B (a/f) (mm ²)	D (a/f) (mm)	F (mm)	 M	
YCSK-6	1.5-6	24	3.2	10	12.7	6.5	M12	E-CU
YCSK-10	2.5-10	27.3	5.5	12.7	19	5.6	M12	E-CU
YCSK-16	4-16	27	7	16	18	6	M14×1.5	E-CU-SN
YCSK-25	6-25	35	9	21	21	6	M18×1.5	E-CU-SN

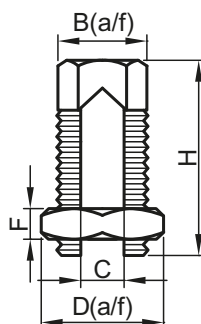





OLVASSA BE A KÓDOT!

- Nézze meg újdonságainkat
- Legyen naprakész

Kínálatunk gyorsan és folyamatosan fejlődik!
Katalógusunk a 2021. áprilisi állapotot tükrözi.
Naprakész információért
látogasson el honlapunkra!

Szigetelt szemes saru

TRACON	d ₁ (mm)	d ₂ (mm)	D (mm)	L (mm)	B (mm)	mm ²			
									
■ PSZ3	1.7	3.7	5.4	18	5.6	1.5	1-1.5	0.75-1	
■ PSZ4	1.7	4.3	5.4	22.3	8	1.5	1-1.5	0.75-1	
■ PSZ5	1.7	5.3	5.4	22.3	8	1.5	1-1.5	0.75-1	
■ PSZ6	1.7	6.4	5.4	27.7	11.5	1.5	1-1.5	0.75-1	
■ PSZ8	1.7	8.4	5.4	27.7	11.5	1.5	1-1.5	0.75-1	
■ PSZ10	1.7	10.5	5.4	31.8	13.6	1.5	1-1.5	0.75-1	
■ K SZ3	2.3	3.7	6.1	22.8	8.4	2.5-4	1.5-2.5	1.5-2.5	
■ K SZ4	2.3	4.4	6.1	22.8	8.4	2.5-4	1.5-2.5	1.5-2.5	
■ K SZ5	2.3	5.3	6.1	23.4	9.4	2.5-4	1.5-2.5	1.5-2.5	
■ K SZ6	2.3	6.4	6.1	28.7	11.7	2.5-4	1.5-2.5	1.5-2.5	
■ K SZ8	2.3	8.4	6.1	28.7	11.7	2.5-4	1.5-2.5	1.5-2.5	
■ K SZ10	2.3	10.5	6.1	32	13.6	2.5-4	1.5-2.5	1.5-2.5	
■ K SZ12	2.3	13	6.1	35	13.6	2.5-4	1.5-2.5	1.5-2.5	
■ SSZ3	3.4	3.7	8	22.1	7.3	6	4-6	4	
■ SSZ4	3.4	4.4	8	28.2	9.4	6	4-6	4	
■ SSZ5	3.4	5.3	8	27.5	9.4	6	4-6	4	
■ SSZ6	3.4	6.4	8	31.5	11.9	6	4-6	4	
■ SSZ8	3.4	8.4	8	36.4	14.9	6	4-6	4	
■ SSZ10	3.4	10.5	8	36.4	14.9	6	4-6	4	
■ SSZ12	3.4	13	8	40	18.9	6	4-6	4	
■ PSZ10-5	4.5	5.3	10	34.1	12.1	10-16	10	6	
■ PSZ10-6	4.5	6.4	10	34.1	12.1	10-16	10	6	
■ PSZ10-8	4.5	8.4	10	40.4	14.8	10-16	10	6	
■ PSZ10-10	4.5	10.5	10.5	38.5	14.8	10-16	10	6	
■ PSZ10-12	4.5	13	10.5	43.4	18.9	10-16	10	6	
■ K SZ16-5	5.7	5.3	12.5	38	11.9	25	16	10	
■ K SZ16-6	5.7	6.4	12.5	37.6	11.9	25	16	10	
■ K SZ16-8	5.7	8.4	12.5	41.6	15.9	25	16	10	
■ K SZ16-10	5.7	10.5	12.5	41.7	15.9	25	16	10	
■ K SZ16-12	5.7	13	12.5	50	22	25	16	10	
■ SSZ25-5	7.7	5.3	15	44.5	16.5	35-50	25-35	16-25	
■ SSZ25-6	7.7	6.4	15	44.5	16.5	35-50	25-35	16-25	
■ SSZ25-8	7.7	8.4	15	44.5	16.5	35-50	25-35	16-25	
■ SSZ25-10	7.7	10.5	15	47.4	17.4	35-50	25-35	16-25	
■ SSZ25-12	7.7	13	15	53.5	22	35-50	25-35	16-25	
■ PSZ35-6	9.4	6.4	18	53.5	22	70	50	35	
■ PSZ35-8	9.4	8.4	18	53.5	22	70	50	35	
■ PSZ35-10	9.4	10.5	18	53.8	22	70	50	35	
■ PSZ35-12	9.4	13	18	53.8	22	70	50	35	

9006; 9006R;
9006RS



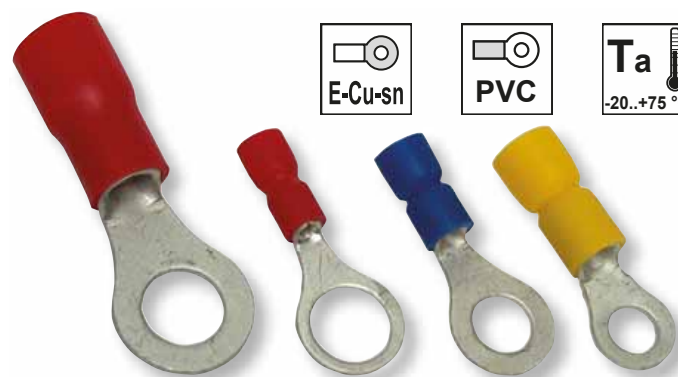

LY35C

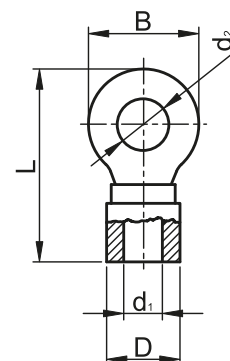

RELEVANT STANDARD
MSZ-05-45.1601-1
EN 61238-1

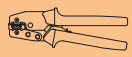

Szigetelt villássaru

TRACON	d ₁ (mm)	d ₂ (mm)	D (mm)	L (mm)	I (mm)	B (mm)	mm ²			
										
■ PV3	1.7	3.7	5.4	21.5	6.4	6.3	1.5	1.5	0.75-1	9006; 9006R; 9006RS
■ PV4	1.7	4.3	5.4	21.5	6.6	7.1	1.5	1.5	0.75-1	
■ PV5	1.7	5.3	5.4	22.5	7.6	7.9	1.5	1.5	0.75-1	
■ PV6	1.7	6.6	5.4	25.5	8.7	10.8	1.5	1.5	0.75-1	
■ KV3	2.3	3.6	6.1	22.7	6.6	6.2	2.5-4	1.5-2.5	1.5-2.5	
■ KV4	2.3	4.3	6.1	22.7	7.1	7.1	2.5-4	1.5-2.5	1.5-2.5	
■ KV5	2.3	5.3	6.1	23	7.6	7.9	2.5-4	1.5-2.5	1.5-2.5	
■ KV6	2.3	6.6	6.1	26.5	8.7	10.7	2.5-4	1.5-2.5	1.5-2.5	
■ SV3	3.4	3.6	8	26.5	7.3	7.2	6	4-6	4	
■ SV4	3.4	4.3	8	27.3	7	8.1	6	4-6	4	
■ SV5	3.4	5.3	8	27.3	7.4	9	6	4-6	4	
■ SV6	3.4	6.4	8	30.3	9.2	10.8	6	4-6	4	

RELEVANT STANDARD
MSZ-05-45.1601-22
MSZ-05-45.1601-1

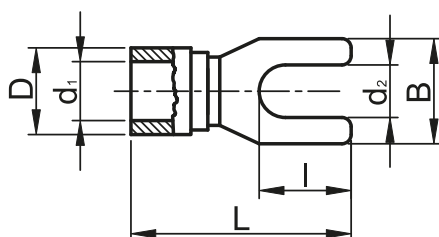
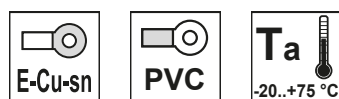

Ajánlott prészerszámok:

TRACON	mm ²
LY35C	10-35
9006RS	0.5-2.5
9006R	2.5-6
9006	2.5-6

B/6

LY35C







9006







9006R



Szigetelt hengeres csatlakozó dugó

TRACON	d ₁ (mm)	d ₂ (mm)	D (mm)	L (mm)	I (mm)	mm ²			
									
■ PH4	1.7	4	4.7	22.6	9	1-2.5	1-1.5	0.75-1	9006; 9006R; 9006RS
■ KH4	2.2	5	5.5	22	9	2.5	1.5-2.5	1.5	
■ SH4	3.6	5	7.5	24.3	9	6	4-6	4	





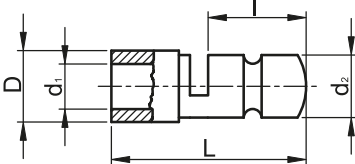











**RELEVANT STANDARD
EN 61238-1**



Szigetelt hengeres csatlakozó aljzat

TRACON	d ₁ (mm)	d ₂ (mm)	D (mm)	L (mm)	mm ²			
								
■ PHA4	1.8	4	5.5	23.8	1-2.5	1-1.5	0.5-1.5	9006; 9006R; 9006RS
■ KHA4	2.1	5	6	23	2.5	1.5-2.5	1.5	
■ SHA4	3.5	5	7.4	25	6	4-6	4	





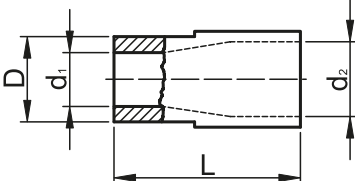











**RELEVANT STANDARD
EN 61238-1**



Szigetelt csapossaru

TRACON	d ₁ (mm)	D (mm)	L (mm)	I ₁ (mm)	B (mm)	mm ²			
									
■ PCS	1.8	5.4	23.3	12	1.9	1-2.5	1-1.5	0.5-1.5	9006; 9006R; 9006RS
■ KCS	2.3	6	23.3	12	1.9	2.5-4	1.5-2.5	1.5-2.5	
■ SCS	3.5	7.8	28.5	13	2.7	6	4-6	4	





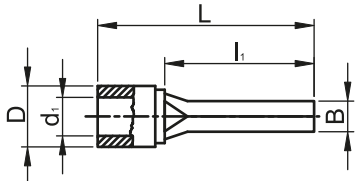







**RELEVANT STANDARD
MSZ-05-45.1601-1
MSZ-05-45.1601-21**



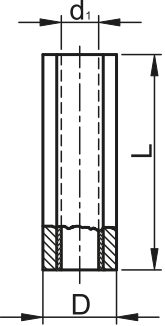

Szigetelt toldóhüvely

TRACON	d_1 (mm)	D (mm)	L (mm)		 mm ²		
■ PTH	2	6	25	1-2.5	0.5-1.5	0.5-1.5	9006; 9006R; 9006RS
■ KTH	2.7	6.5	25	2.5-4	1.5-2.5	1.5-2.5	
■ STH	3.9	8	27	4-6	4-6	4	



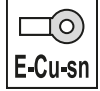
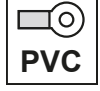
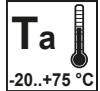





RELEVANT STANDARD
MSZ-05-45.1601-1
MSZ-05-45.1601-21





Zsugorodó szigetelésű toldóhüvely

TRACON	d_1 (mm)	D (mm)	L (mm)		 mm ²		
■ ZSTHP	1.8	4.6	37	1-1.5	0.5-1.5	0.75-1	9006; 9006R; 9006RS
■ ZSTHK	2.6	5.4	36.6	2.5-4	1.5-2.5	1.5-2.5	
■ ZSTHS	3.6	6.6	42	4-6	4-6	2.5-4	

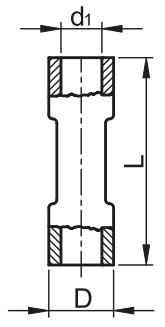

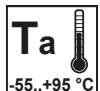
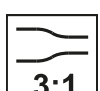

RELEVANT STANDARD
MSZ-05-45.1601-1
MSZ-05-45.1601-21

Hőre zsugorodó hüvely ónnal

TRACON	d_1 (mm)	D (mm)	L (mm)	 mm ²
□ THSN0,5	2	2.5	24	0.5-1
■ THSN1	2.6	4.4	40	1-1.5
■ THSN2,5	4.2	6.2	42	2.5-4
■ THSN6	6	7	40	4-6

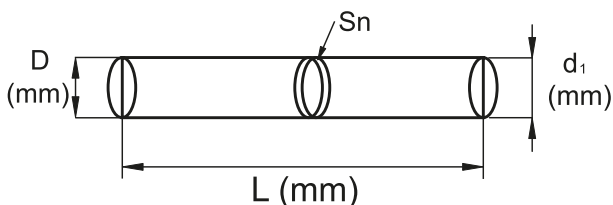

Szigeteletlen rátolható csatlakozó hüvely

TRACON		d ₁ (mm)	L (mm)	I ₁ (mm)	I ₂ (mm)	W (mm)	mm ²	
CSH3	2.8 × 0.5	2.7	15.5	6.7	–	3.8	0.5-1	
CSH5	4.8 × 0.5	3.1	15.5	6.4	–	5.7	0.5-1	
CSH6	6.3 × 0.8	3.7	19.5	7.7	–	7.6	1-2.5	LY03B; LY03BR
CSH6-2	6.3 × 0.8	4.3	19	7.7	–	7.6	4-6	
CSH6-B	6.3 × 0.8	3.7	20	7.7	–	7.6	1-2.5	
CSH09B	7.7 × 0.8	3.7	13.4	8.3	16.7	9	1-2.5	–



CSH6-B



CSH09B

CSH3



CSH5, CSH6,
CSH6-2

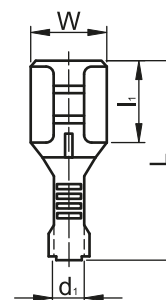
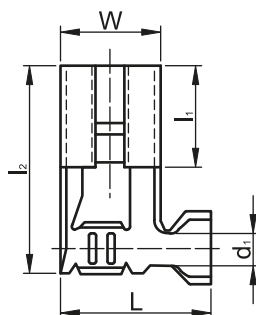
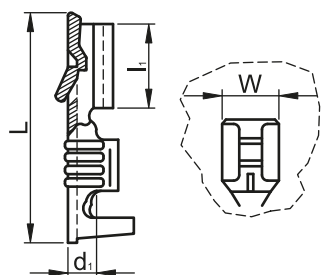



RELEVANT STANDARD
EN 61210

Ajánlott prészerszámok:

TRACON	mm ²
LY03BR	0.5-6
LY03B	0.5-6



Szigeteletlen sárgaréz rátolható csatlakozó csap



TRACON		d_1 (mm)	L (mm)	l_1 (mm)	W (mm)	 mm ²	
CS3		2.8 × 0.5	2.7	13.3	6	2.8	0.5-1
CS5		4.8 × 0.5	3.1	17.9	6.4	4.8	0.5-1
CS6		6.3 × 0.8	2.6	20.3	8.4	6.3	0.75-1.5
CS6B		6.3 × 0.8	3.7	28.7	16.5	6.3	1-2.5

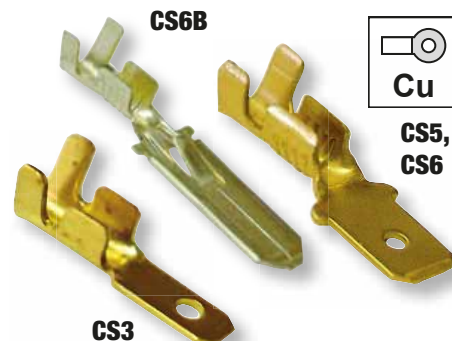
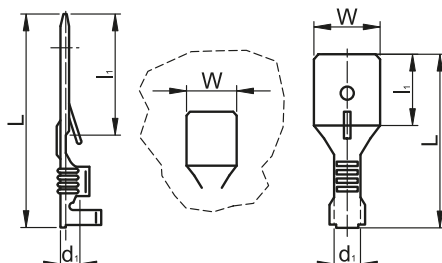

RELEVANT STANDARD
EN 61210



Rátolható csatlakozó csap hüvellyel

TRACON		d_1 (mm)	L (mm)	l_1 (mm)	l_2 (mm)	W (mm)	 mm ²	
CSE		6.3 × 0.8	3.7	20	7.7	8	6.3	1-2.5
CSEL		6.3 × 0.8	-	18.8	7.7	8.1	6.3	1-2.5



RELEVANT STANDARD
EN 61210

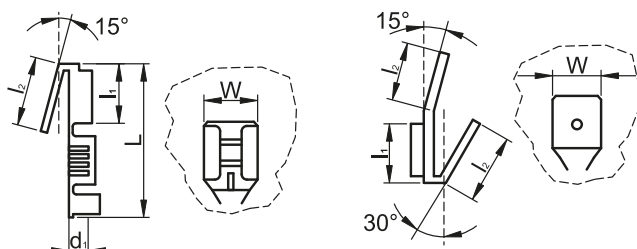

Csavaros rögzítésű szigeteletlen csatlakozó csap

TRACON		d (mm)	L (mm)	l_1 (mm)	W (mm)	α
CSA-45-4		6.3 × 0.8	4.4	16.5	8.2	45°
CSA-45-5		6.3 × 0.8	5.2	16.5	8.2	45°
CSA-90-5		6.3 × 0.8	5.2	16.5	8.2	90°



RELEVANT STANDARD
EN 61210

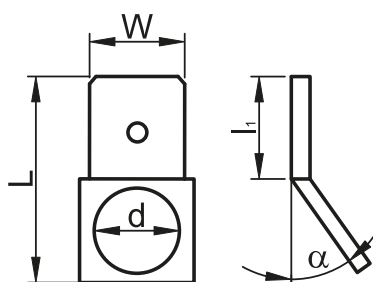

Könnyített PVC szigetelés rátolható csatlakozókhoz

TRACON		L (mm)	A (mm)	B (mm)	C (mm)
SZICSH5	CSH5	17.7	6.9	3	4.3
SZICSH6	CS5, CSH6	21.4	7.4	3.3	6.5
SZICS6	CS6	22.8	9	4.7	6.9

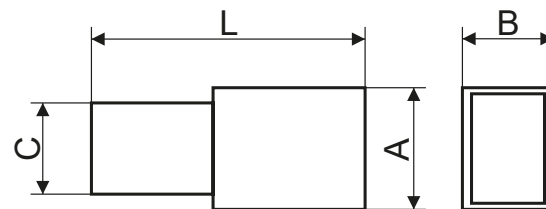

RELEVANT STANDARD
EN 61210



Sajtolható szigetetlen szemessaru

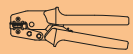

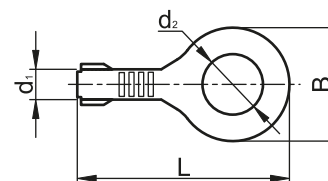
TRACON	d ₁ (mm)	d ₂ (mm)	B (mm)	L (mm)	 mm ²	
HSZ4	3.7	4.3	10	23.2	1-2.5	LY03B; LY03BR
HSZ5	3.7	5.4	10	23.2	1-2.5	
HSZ6	3.7	6.4	9.5	19.6	1-2.5	
HSZ8	4.9	8.4	13.5	25	2.5-4	



RELEVANT STANDARD
EN 61210

 **Piktogramok A/0**

Szigetelt rátolható csatlakozó csap hüvellyel



TRACON		d ₁ (mm)	D (mm)	L (mm)	l ₁ (mm)	W (mm)	 mm ²		
PCSE	6.3 × 0.8	1.7	4.6	22.6	8.6	6.3	1.5	1-1.5	9006; 9006R
KCSE	6.3 × 0.8	2.1	5.5	23.7	8.6	6.3	2.5	1.5-2.5	

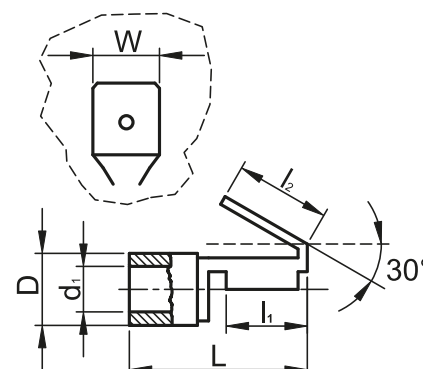

RELEVANT STANDARD
EN 61210



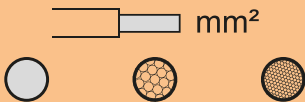

Szigetelt rátolható csatlakozó hüvely

TRACON		d_1 (mm)	D (mm)	L (mm)	l_1 (mm)	W (mm)		mm ²	
■ PCSH3	2.8 × 0.5	1.7	3.7	20.2	6.4	3.1	1.5	1-1.5	0.75-1
■ PCSH5	4.8 × 0.8	2	3.6	20.5	6.4	5.1	1.5	1-1.5	0.75-1
■ PCSH6	6.3 × 0.8	1.7	3.7	22.2	7.5	6.6	1.5	1-1.5	0.75-1
■ KCSH3	2.8 × 0.5	2.4	4.5	20.2	6.3	3.2	2.5-4	2.5	1.5
■ KCSH5	4.8 × 0.8	2.4	4.4	20.8	6.2	5.1	2.5-4	2.5	1.5
■ KCSH6	6.3 × 0.8	2.4	4.3	22.1	7.5	6.6	2.5-4	2.5	1.5
■ SCSH6	6.3 × 0.8	3.4	6.5	23	7.5	7.3	6	4-6	4

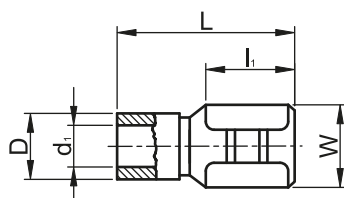
9006; 9006R

RELEVANT STANDARD
EN 61210

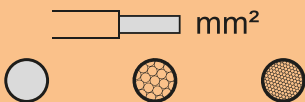

Szigetelt rátolható csatlakozó csap

TRACON		d_1 (mm)	D (mm)	L (mm)	l_1 (mm)	W (mm)		mm ²	
■ PCS5	4.8 × 0.5	1.7	4	19.2	7.6	4.8	1.5	1-1.5	0.75-1
■ PCS6	6.3 × 0.8	1.7	3.8	22.1	7.6	6.3	1.5	1-1.5	0.75-1
■ KCS5	4.8 × 0.5	2.4	4.6	18.9	6.5	4.8	2.5-4	2.5	1.5
■ KCS6	6.3 × 0.8	2.1	4.6	22.2	7.7	6.3	2.5-4	2.5	1.5
■ SCS6	6.3 × 0.8	3.5	5.4	23.2	8.4	6.3	6	4-6	4

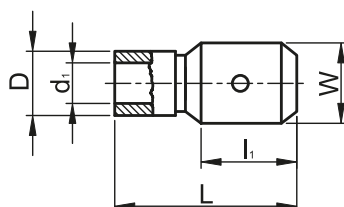
9006; 9006R

RELEVANT STANDARD
EN 61210

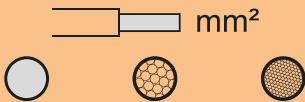
Teljes szigetelésű rátolható csatlakozó hüvely

TRACON		d_1 (mm)	D (mm)	L (mm)	l_1 (mm)	W (mm)		mm ²	
■ PTCSH3	2.8 × 0.5	2	4.2	19	6.4	3.2	1.5	1-1.5	0.75-1
■ PTCSH5	4.8 × 0.8	2	4.1	19.6	6.4	5.2	1-1.5	0.75-1	0.75-1
■ PTCSH6	6.3 × 0.8	2	4.2	21	7.5	6.6	1.5	1-1.5	0.75-1
■ KTCSH3	2.8 × 0.5	2.5	4.4	18.8	6.3	3.2	2.5-4	2.5	1.5
■ KTCSH5	4.8 × 0.8	2.5	4.7	19.2	6.2	5.1	2.5-4	2.5	1.5
■ KTCSH6	6.3 × 0.8	2.5	4.6	21.7	7.5	6.6	2.5-4	2.5	1.5
■ STCSH6	6.3 × 0.8	3.6	5.7	22.3	7.5	6.6	6	4-6	4

9006; 9006R

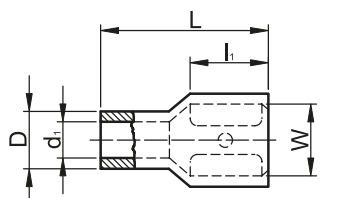
RELEVANT STANDARD
EN 61210

Szigeteletlen érvég hüvelyek

TRACON	 mm ²	D (mm)	d ₁ (mm)	S (mm)	L (mm)
E01NR6	0.5	1.3	1	0.2	6
E01NR	0.5	1.3	1	0.2	8
E01N	0.5	1.3	1	0.2	10
E02NR	0.75	1.5	1.2	0.2	8
E02N	0.75	1.5	1.2	0.2	10
E03NR	1	1.8	1.4	0.2	8
E03N	1	1.8	1.4	0.2	10
E04NR	1.5	2	1.7	0.2	8
E04N	1.5	2	1.7	0.2	10
E05NR	2.5	2.6	2.2	0.2	8
E05N	2.5	2.6	2.2	0.2	10
E06NR	4	3.2	2.8	0.2	9
E06N	4	3.2	2.8	0.2	12
E07NR	6	3.9	3.5	0.2	12
E07N	6	3.9	3.5	0.2	15
E08NR	10	4.9	4.5	0.2	12
E08N	10	4.9	4.5	0.2	15
E09N	16	6.2	5.8	0.2	15
E10N	25	7.9	7.5	0.2	16
E11N	35	8.7	8.3	0.25	16
E12N	50	10.9	10.3	0.3	20
E13N	70	15.3	13.5	0.4	22
E14N	95	16.8	14.6	0.4	32
E08N-18	10	4.9	4.5	0.2	18
E09N-12	16	6.2	5.8	0.2	12
E09N-18	16	6.2	5.8	0.2	18
E10N-18	25	7.9	7.5	0.2	18
E12N-18	50	10.9	10.3	0.3	18
E14N-25	95	16.8	14.6	0.4	25
E15N-30	120	16.8	14.6	0.4	30
E16N-32	150	16.8	14.6	0.4	32

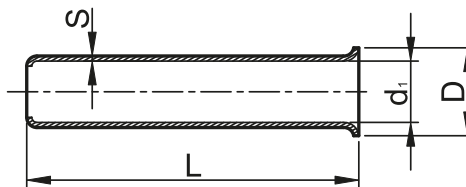

A narancs színnel kiemelt méretek standard méretek.























































RELEVANT STANDARD
EN 61238-1

RELEVANT STANDARD
MSZ-05-45.1601-26

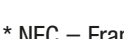
Ajánlott prészerszámok érvég hüvelyekhez:

TRACON	 mm ²	TRACON	 mm ²	TRACON	 mm ²
9102-LT	0.25-2.5	9039AR	0.5-6	F6L	0.5-6
9004-LT	0.5-16	9039BR	10-35	F25L	6-25
9039	6-16	9039A-SPEC	0.25-6	F50L	35-50
9039A	1.5-6	9039B-SPEC	6-16		
9039B	10-35	9039-HEXA	0.25-6		

Szigetelt érvéghüvelkek

TRACON	(NFC)*	TRACON	(DIN-VDE)**	mm ²	d ₁ (mm)	d ₂ (mm)	L (mm)	l (mm)	S ₁ (mm)	S ₂ (mm)
	E034		E134	0.25	0.8	1.5	10.4	6	0.15	0.25
			E135	0.25	0.8	1.5	12.8	8	0.15	0.25
			E136	0.34	0.8	1.9	10.4	6	0.15	0.3
			E137	0.34	0.8	1.9	12.8	8	0.15	0.3
			E010	0.5	1	2.6	12	6	0.15	0.25
			E020	0.5	1	2.6	14	8	0.15	0.25
			E030	0.5	1	2.6	16	10	0.15	0.25
			E040	0.75	1.2	2.8	12.4	6	0.15	0.25
	E05		E050	0.75	1.2	2.8	14.6	8	0.15	0.25
			E060	0.75	1.2	2.8	16.4	10	0.15	0.25
			E070	0.75	1.2	2.8	18.4	12	0.15	0.25
			E080	1	1.4	3	12.4	6	0.2	0.3
	E09		E090	1	1.4	3	14.6	8	0.2	0.3
			E100	1	1.4	3	16.4	10	0.2	0.3
			E110	1	1.4	3	18.4	12	0.2	0.3
	E13		E113	1.5	1.7	3.5	14.6	8	0.15	0.25
			E114	1.5	1.7	3.5	16.4	10	0.15	0.25
	E14			1.5	1.7	3.5	18	12	0.15	0.25
			E115	1.5	1.7	3.5	25	18	0.15	0.25
	E16		E116	2.5	2.3	4	15.2	8	0.15	0.25
			E117	2.5	2.3	4	19.2	12	0.15	0.25
			E118	2.5	2.3	4	25.2	18	0.15	0.25
	E19		E119	4	2.8	4.4	16.5	9	0.2	0.3
			E120	4	2.8	4.4	19.5	12	0.2	0.3
			E121	4	2.8	4.4	25.5	18	0.2	0.3
	E22		E122	6	3.5	6.3	20	12	0.2	0.3
			E123	6	3.5	6.3	26	18	0.2	0.3
	E24		E124	10	4.5	7.6	21.5	12	0.2	0.4
			E125	10	4.5	7.6	27.5	18	0.2	0.4
	E26		E126	16	5.8	8.8	22.2	12	0.2	0.4
			E127	16	5.8	8.8	28.2	18	0.2	0.4
	E28		E128	25	7.5	11.2	29	16	0.2	0.4
	E29		E129	25	7.5	11.2	35	22	0.2	0.4
	E30		E130	35	8.3	12.7	30	16	0.2	0.4
			E131	35	8.3	12.7	39	25	0.2	0.4
	E32		E132	50	10.3	15.3	36	20	0.3	0.6
			E133	50	10.3	15.3	41	25	0.3	0.6
			E140	70	13	16.7	37.5	21	0.5	0.75
			E142	95	14.5	18	43.6	25	0.6	1
			E144	120	16.6	20.4	48	27	0.6	1
			E146	150	20	23.5	58	32	0.6	1

* NFC = Francia Nemzeti Szabvány

** DIN-VDE = Német Ipari Szabvány

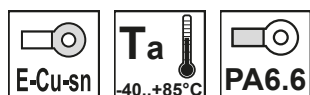
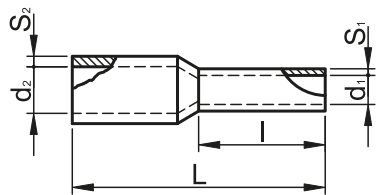













RELEVANT STANDARD
EN 61238-1
MSZ-05-45.1601-26



A narancs színnel kiemelt méretek standard méretek.







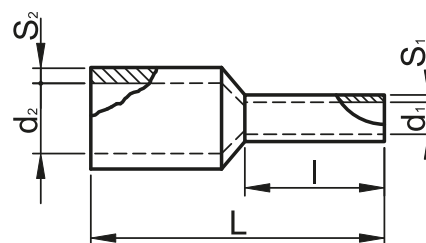
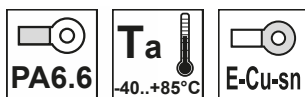

Ikerérvégművelők

TRACON		d_1 (mm)	d_2 (mm)	L (mm)	l (mm)	S_1 (mm)	S_2 (mm)
 E20I	2 × 0.5	1.5	4.7	15	8	0.2	0.5
 E50I	2 × 0.75	1.8	5	16	8	0.2	0.4
 E50IH	2 × 0.75	1.8	5	17.5	10	0.2	0.5
 E90I	2 × 1.0	2.3	5.4	15	8	0.15	0.3
 E90IH	2 × 1.0	2.3	5.4	18	10	0.2	0.5
 E13IR	2 × 1.5	2.3	6.5	16	8	0.2	0.4
 E13I	2 × 1.5	2.3	6.5	20	12	0.15	0.3
 E16IR	2 × 2.5	2.8	7.8	20	10	0.2	0.5
 E16I	2 × 2.5	2.8	7.8	22.5	13	0.2	0.5
 E19I	2 × 4.0	3.8	9	23.5	12	0.2	0.5
 E22I	2 × 6.0	4.9	10.2	25.5	14	0.2	0.4
 E24I	2 × 10.0	6.5	13	26.5	14	0.2	0.5
 E26I	2 × 16.0	8.3	18.7	32	14	0.3	0.5

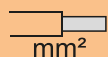

RELEVANT STANDARD
EN 61238-1
MSZ-05-45.1601-26

Rácsavarható vezetékösszekötők

TRACON			D (mm)	L (mm)
 TFM1	0.5-1.5	10	8.6	15
 TFM2	0.75-2.5	10	9.7	17.3
 TFM3	1-4	10	11.1	21
 TFM4	1.5-6	10	14	24.7

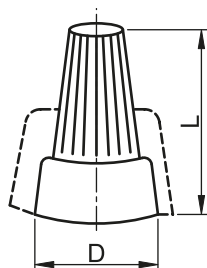
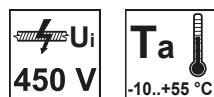
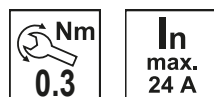
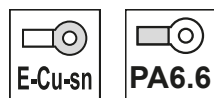

RELEVANT STANDARD
EN 60998-1

RELEVANT STANDARD
EN 60998-2-4



Vezeték típus: merev réz

Csavaros vezetékösszekötők

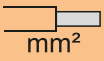
TRACON		 mm ²	L (mm)	W (mm)	H (mm)
TRK4	sárga házzal, 4 db kötéshez	1.5-4	19.5	13.4	13.4
TBT-2,5	átlátszó házzal, 5 tagú, 1 csavarral	2.5	49.7	17.4	17.8
TBT-4	átlátszó házzal, 5 tagú, 1 csavarral	4	58.5	20	20
TBT-6	átlátszó házzal, 5 tagú, 1 csavarral	6	67.5	22.5	23.5
TBT-10	átlátszó házzal, 5 tagú, 1 csavarral	10	82	27	27
TBT-16	átlátszó házzal, 5 tagú, 1 csavarral	16	110	33.1	33
TBT-2,5/10	átlátszó házzal, 10 tagú, 1 csavarral	2.5	100	17.4	18
TBT-4/10	átlátszó házzal, 10 tagú, 1 csavarral	4	115.2	20.1	19.1
TBT-6/10	átlátszó házzal, 10 tagú, 1 csavarral	6	134.2	22.6	22.5
TBT-10/10	átlátszó házzal, 10 tagú, 1 csavarral	10	161.8	26.9	26.5
TBT-16/10	átlátszó házzal, 10 tagú, 1 csavarral	16	220	31.3	32

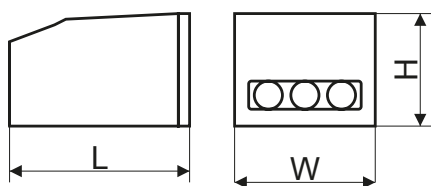

450 V AC
In max. 40 A
IP 20
PA6.6
Cu
Ta -10..+55 °C
500 V

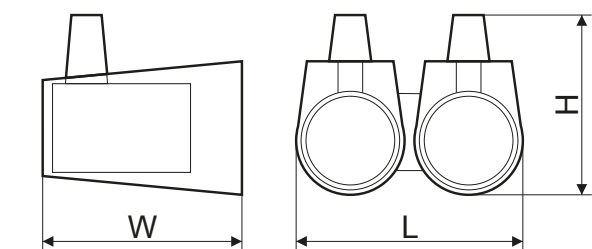
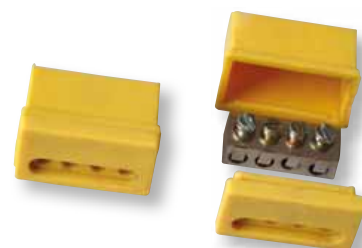

**RELEVANT STANDARD
EN 61210**

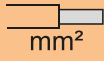

Késes leágaztatók

TRACON	L (mm)	W (mm)	H (mm)	 mm ²	In
PL	19.5	16	16	0.5-1	10 A
KL	19.5	16	11	1.5-2.5	20 A
SL	20	17	16	4-6	50 A



E-Cu-sn
PVC
50 V DC
Ta -20..+75 °C

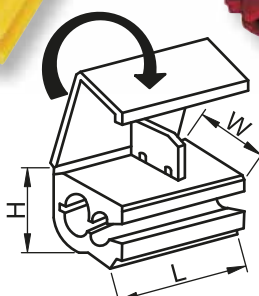

Csillárkapocs

TRACON	 mm ²				L (mm)	W (mm)	H (mm)
OLC11D	1 × 0.5-2.5	1 × 0.5-2.5	1 × 0.5-2.5	1 × 0.5-2.5	42.6	10.6	16.4
OLC11	1 × 1-2.5	–	1 × 0.5-2.5	1 × 0.5-2.5	20.5	8.1	15.1
OLC21	2 × 1-2.5	–	1 × 0.5-2.5	1 × 0.5-2.5	20.5	9.7	15.6

V0
UL94

 E-Cu-sn

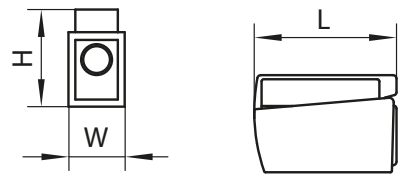

 PA6.6



 U_i
400 V

IP
20

I_n
max.
24 A

T_a
-10..+55 °C

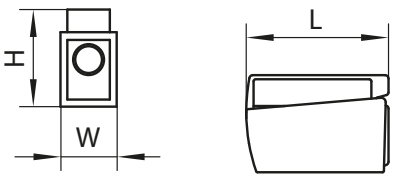
Csavar nélküli vezetékösszekötők

TRACON	 mm ²	L (mm)	W (mm)	H (mm)
TRC252	2 × 0.5-4	19	10.5	9.5
TRC253	3 × 0.5-4	19	13.5	9.5
TRC254	4 × 0.5-4	19	17.5	9.5
TRC255	5 × 0.5-4	19	21	9.5
RV02,5-2	2 × 0.5-2.5	16.6	10	6
RV02,5-3	3 × 0.5-2.5	16.6	13.9	6
RV02,5-4	4 × 0.5-2.5	16.6	18	6
RV02,5-5	5 × 0.5-2.5	16.6	22.2	6
RV02,5-8	8 × 0.5-2.5	16.6	18.1	11

V0
UL94

 E-Cu-sn

 PA6.6

 U_i
500 V

IP
20

I_n
max.
24 A

T_a
-10..+55 °C

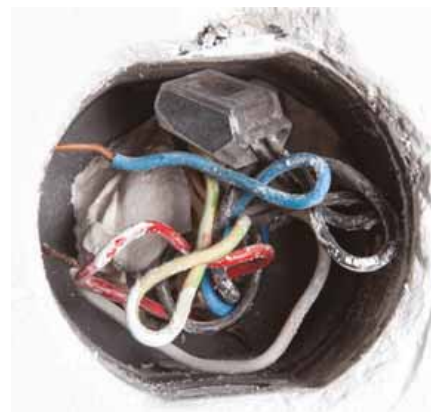
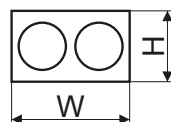
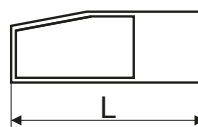
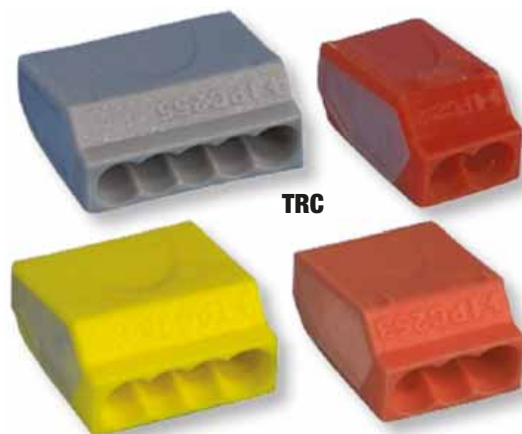

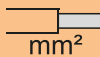

RELEVANT STANDARD
EN 60998-1
EN 60998-2-4

Nyitható és csavar nélküli vezetékösszekötők, lapos kivitel

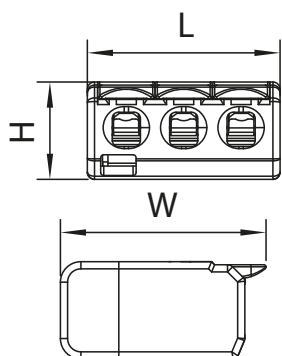
TRACON	 mm ²	L (mm)	W (mm)	H (mm)
RVON2	2 × 0.2-4	13.2	20.1	9.5
RVON3	3 × 0.2-4	18.8	20.1	9.5
RVON5	5 × 0.2-4	30	20.1	9.5



V0 UL94
  E-Cu-sn
  PC
 In max. 32 A
 Ta -10..+85 °C
 IP 20
  U_i 450 V AC
 450 V AC

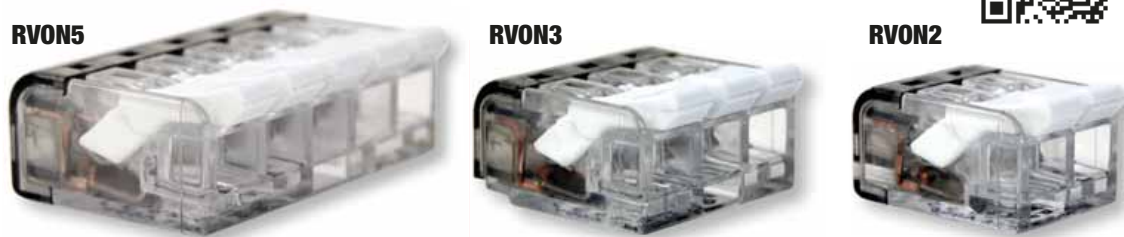

Nyitható és csavar nélküli vezetékösszekötők, hagyományos kivitel

TRACON	 mm ²	L (mm)	W (mm)	H (mm)
OV02,5-2	2 × 0.5-4	12.4	20.5	14.5
OV02,5-3	3 × 0.5-4	17	20.5	14.5
OV02,5-5	5 × 0.5-4	26.6	20.5	14.5
OV0T2,5-2	2 × 0.5-4	12.4	20.5	14.5
OV0T2,5-3	3 × 0.5-4	17	20.5	14.5
OV0T2,5-5	5 × 0.5-4	26.6	20.5	14.5

V0 UL94
  E-Cu-sn
  PA6.6
  U_i 400 V
 IP 20
 In max. 32 A
 Ta -10..+55 °C

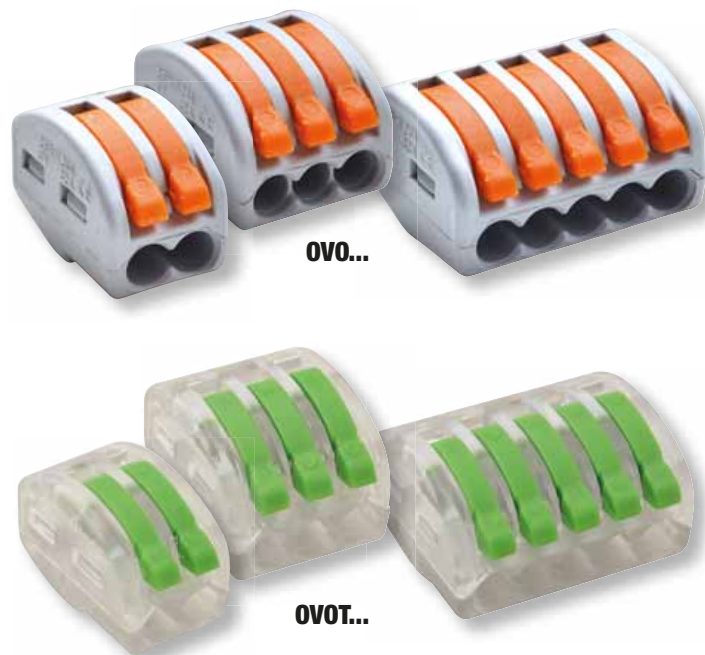
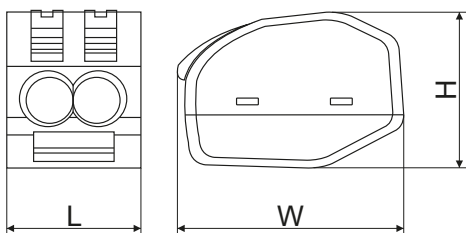

Adapter nyitható vezetékösszekötőhöz, sínre szerelhető

TRACON	L (mm)	W (mm)	H (mm)
OV0-A1	23	66	31

Hátlap nyitható vezetékösszekötő adapteréhez

TRACON	L (mm)	W (mm)	H (mm)
OV0-A2	5	67	52

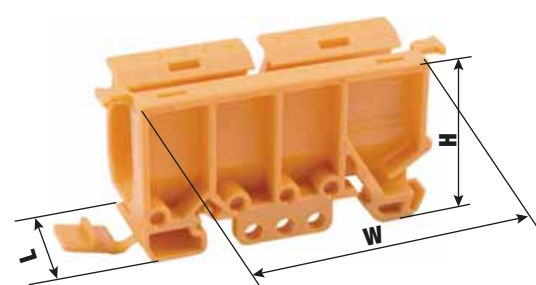

V2 UL94
  PA6.6
 Ta -20..+75 °C

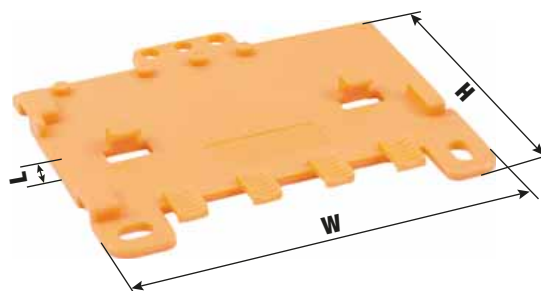

Csatlakozó napelemhez



600/1000 V AC/DC	U _i 1 kV	I _n max. 20 A	R ≥ 0.5mΩ	V5/V0 UL94	PC/PA6.6	T _a -40..+85°C	[mm ²] 2,5-4	UV ☺	MC4
---------------------	------------------------	--------------------------------	--------------	---------------	----------	------------------------------	-----------------------------	------	-----

TRACON	IP..
SOLAR11-4AB	IP 68
SOLAR11-4N	IP 67
SOLAR1-2AB	IP 67

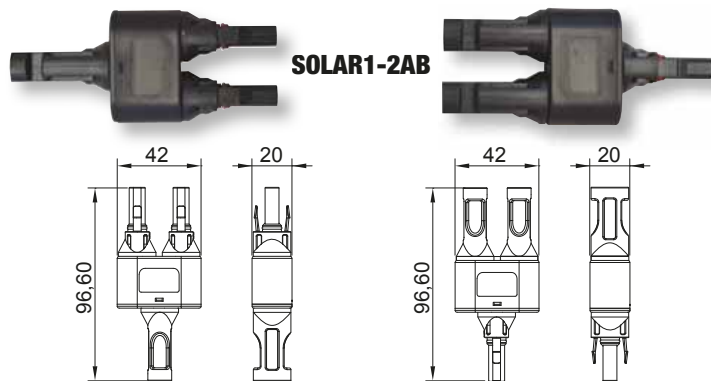

RELEVANT STANDARD
EN 50521

RELEVANT STANDARD
IEC 61646

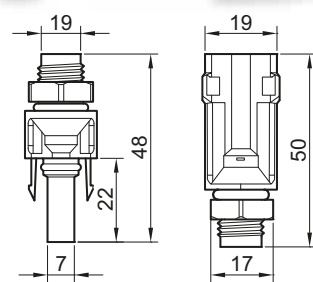

A napelem panelek általában az előre szerelt vezeték végekkel könnyen összeköthetőek. Az így összekötött napelem modultól kell egyenáramú vezetékvezést kialakítani az inverterig vagy az inverter előtt elhelyezett csatlakozó szekrényig. Kivitelét tekintve tömítőszelencés (teljes tömítéssel IP68) és ellenanyag típusú. Présszerszámmal préselhető. Párban forgalmazzuk.

Présszerszám napelemes csatlakozókhoz
SOLAR11-PT **B/3**

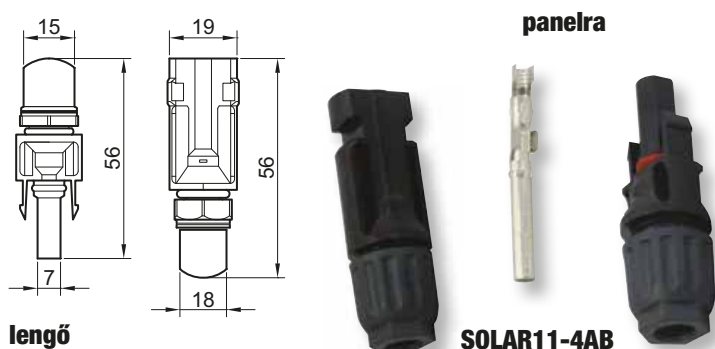

Felszálló fővezeték elosztókapocs

TRACON	mm ²		I _n	L (mm)	W (mm)	H (mm)
FFE35-50	35-50	25-35	150 A	60	30	50
FFE50-70	50-70	35-50	192 A	65	35	55
FFE70-95	70-95	50-70	232 A	70	40	60
FFE150-185	150-185	95-150	353 A	75	45	65
FFE95-240	95-240	70-185	415 A	80	50	70

PA6.6 V2 UL94 E-Cu-sn

H, W, L

RELEVANT STANDARD
EN 60999

400 V AC



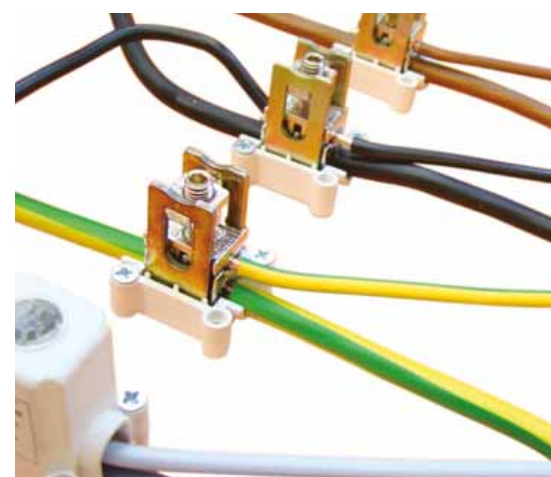

IP 20

U_i
500 V

T_a
-10..+55°C



Fővezetéki leágazó sorkapocs, multicolor

TRACON	mm ²				In		IN	OUT	W1 (mm)	W2 (mm)
FLS35/4X9	1 × 35	1 × 25	9 × 4	9 × 2.5	125 A		1 × M8	9 × M4	16.3	20.4
FLS35/10X4	1 × 35	1 × 25	4 × 10	4 × 6	125 A		1 × M8	4 × M5	16.3	20.4
FLS50/16X4	1 × 50	1 × 35	4 × 16	4 × 10	150 A		1 × M8	4 × M6	24.2	28.2
FLS70/10X8	1 × 70	1 × 50	8 × 10	8 × 6	192 A		1 × M10	8 × M6	32.2	36.1

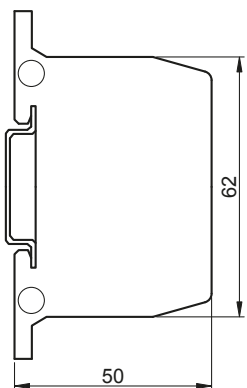
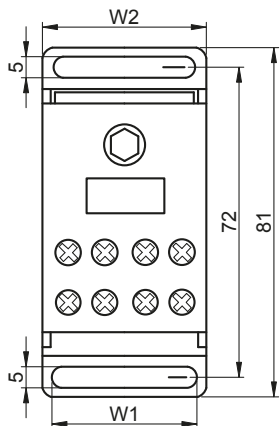





















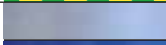





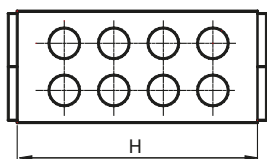
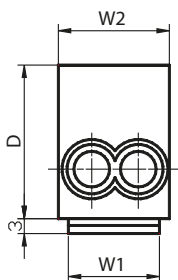

RELEVANT STANDARD
EN 60998-1



Főáramköri leágazó kapocs

TRACON	mm ²				In		W1 (mm)	W2 (mm)	D (mm)	H (mm)
FLE-16							22.2	27.4	39.5	43.1
FLE-16K	2 × 16	2 × 10	2 × 16	2 × 10	76 A		22.2	27.4	39.5	43.1
FLE-16ZS							22.2	27.4	39.5	43.1
FLE-25							22.2	27.4	39.5	43.1
FLE-25K	2 × 25	2 × 16	2 × 25	2 × 16	101 A		22.2	27.4	39.5	43.1
FLE-25ZS							22.2	27.4	39.5	43.1
FLE-35/25							20	26.9	43.6	53
FLE-35/25K	1 × 35	1 × 25	1 × 35	1 × 25	125 A		20	26.9	43.6	53
FLE-35/25ZS	1 × 25	1 × 16	1 × 25	1 × 16			20	26.9	43.6	53



Főáramköri leágazó kapocs, sínre szerelhető

TRACON	mm ²				In	Ui	X		W (mm)	L (mm)	H (mm)	X
FLEAL-50/1	1 × 50	1 × 35	1 × 50	1 × 35	160 A	800 V	1P		17.9	51	43.7	2 × M5
FLEAL-50/1K	1 × 50	1 × 35	1 × 50	1 × 35	160 A	800 V	1P		17.9	51	43.7	2 × M5
FLEAL-50/1ZS	1 × 50	1 × 35	1 × 50	1 × 35	160 A	800 V	1P		17.9	51	43.7	2 × M5
FLEAL-50/2	2 × 50	2 × 35	2 × 50	2 × 35	160 A	800 V	1P		31.1	51	43.7	4 × M5
FLEAL-50/2K	2 × 50	2 × 35	2 × 50	2 × 35	160 A	800 V	1P		31.1	51	43.7	4 × M5
FLEAL-50/2ZS	2 × 50	2 × 35	2 × 50	2 × 35	160 A	800 V	1P		31.1	51	43.7	4 × M5
FLEAL-50/3	3 × 50	3 × 35	3 × 50	3 × 35	160 A	800 V	1P		42.3	51	43.7	6 × M5
FLEAL-50/3K	3 × 50	3 × 35	3 × 50	3 × 35	160 A	800 V	1P		42.3	51	43.7	6 × M5
FLEAL-50/3ZS	3 × 50	3 × 35	3 × 50	3 × 35	160 A	800 V	1P		42.3	51	43.7	6 × M5

400 V AC **V0 UL94** **Al-sn** **Ta** -20...+75 °C **PA6.6** **35×7.5** **IP 20**



FLEAL-50/1

FLEAL-50/2K

FLEAL-50/3ZS

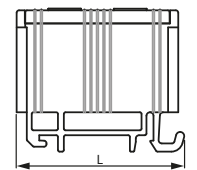
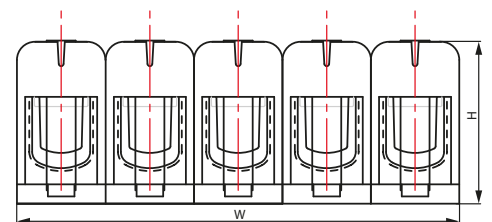

Főáramköri leágazó kapocs, felületre szerelhető

TRACON	mm ²				In	Ui	X		W (mm)	L (mm)	H (mm)	X
FLEAL-240/1	1 × 240	1 × 185	1 × 240	1 × 185	425 A	800 V	1P		36.6	130.6	67.2	2 × M8
FLEAL-240/1K	1 × 240	1 × 185	1 × 240	1 × 185	425 A	800 V	1P		36.6	130.6	67.2	2 × M8
FLEAL-240/1ZS	1 × 240	1 × 185	1 × 240	1 × 185	425 A	800 V	1P		36.6	130.6	67.2	2 × M8
FLEAL-240/2	2 × 240	2 × 185	2 × 240	2 × 185	425 A	800 V	1P		63.4	130.6	67.2	4 × M8
FLEAL-240/2K	2 × 240	2 × 185	2 × 240	2 × 185	425 A	800 V	1P		63.4	130.6	67.2	4 × M8
FLEAL-240/2ZS	2 × 240	2 × 185	2 × 240	2 × 185	425 A	800 V	1P		63.4	130.6	67.2	4 × M8
FLEAL-240/3	3 × 240	3 × 185	3 × 240	3 × 185	425 A	800 V	1P		93	130.6	67.2	6 × M8
FLEAL-240/3K	3 × 240	3 × 185	3 × 240	3 × 185	425 A	800 V	1P		93	130.6	67.2	6 × M8
FLEAL-240/3ZS	3 × 240	3 × 185	3 × 240	3 × 185	425 A	800 V	1P		93	130.6	67.2	6 × M8



FLEAL-240/1



FLEAL-240/2K

FLEAL-240/3ZS

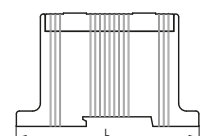
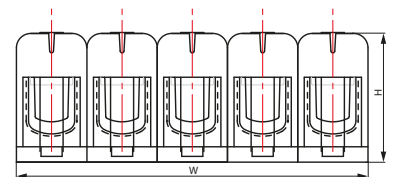
PA6.6 **400 V AC**
V0 UL94 **Ta** -20...+75 °C
Al-sn **IP 20**

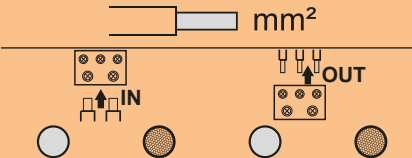

Főáramköri leágazó kapocs, sínre és felületre szerelhető

TRACON					I_n	U_i	X		W (mm)	L (mm)	H (mm)	X 
FLEAL-35	5 × 35	5 × 25	5 × 35	5 × 25	135 A	1000 V	5P		80	45.2	40.2	10 × M4
FLEAL-95/1	1 × 95	1 × 70	1 × 95	1 × 70	245 A	800 V	1P		23.7	89.1	49.6	2 × M5
FLEAL-95/1K	1 × 95	1 × 70	1 × 95	1 × 70	245 A	800 V	1P		23.7	89.1	49.6	2 × M5
FLEAL-95/1ZS	1 × 95	1 × 70	1 × 95	1 × 70	245 A	800 V	1P		23.7	89.1	49.6	2 × M5
FLEAL-95/2	2 × 95	2 × 70	2 × 95	2 × 70	245 A	800 V	1P		41.6	89.1	49.6	4 × M5
FLEAL-95/2K	2 × 95	2 × 70	2 × 95	2 × 70	245 A	800 V	1P		41.6	89.1	49.6	4 × M5
FLEAL-95/2ZS	2 × 95	2 × 70	2 × 95	2 × 70	245 A	800 V	1P		41.6	89.1	49.6	4 × M5
FLEAL-95/3	3 × 95	3 × 70	3 × 95	3 × 70	245 A	800 V	1P		60.9	89.1	49.6	6 × M5
FLEAL-95/3K	3 × 95	3 × 70	3 × 95	3 × 70	245 A	800 V	1P		60.9	89.1	49.6	6 × M5
FLEAL-95/3ZS	3 × 95	3 × 70	3 × 95	3 × 70	245 A	800 V	1P		60.9	89.1	49.6	6 × M5
FLEAL-150/1	1 × 150	1 × 120	1 × 150	1 × 120	320 A	800 V	1P		28.9	96.6	59.2	2 × M8
FLEAL-150/1K	1 × 150	1 × 120	1 × 150	1 × 120	320 A	800 V	1P		28.9	96.6	59.2	2 × M8
FLEAL-150/1ZS	1 × 150	1 × 120	1 × 150	1 × 120	320 A	800 V	1P		28.9	96.6	59.2	2 × M8
FLEAL-150/2	2 × 150	2 × 120	2 × 150	2 × 120	320 A	800 V	1P		50.9	96.6	59.2	4 × M8
FLEAL-150/2K	2 × 150	2 × 120	2 × 150	2 × 120	320 A	800 V	1P		50.9	96.6	59.2	4 × M8
FLEAL-150/2ZS	2 × 150	2 × 120	2 × 150	2 × 120	320 A	800 V	1P		50.9	96.6	59.2	4 × M8
FLEAL-150/3	3 × 150	3 × 120	3 × 150	3 × 120	320 A	800 V	1P		72.8	96.6	59.2	6 × M8
FLEAL-150/3K	3 × 150	3 × 120	3 × 150	3 × 120	320 A	800 V	1P		72.8	96.6	59.2	6 × M8
FLEAL-150/3ZS	3 × 150	3 × 120	3 × 150	3 × 120	320 A	800 V	1P		72.8	96.6	59.2	6 × M8



FLEAL-35



FLEAL-95/1, FLEAL-150/1



FLEAL-95/1K, FLEAL-150/1K



FLEAL-95/1ZS, FLEAL-150/1ZS



FLEAL-95/2, FLEAL-150/2



FLEAL-95/2K, FLEAL-150/2K



FLEAL-95/2ZS, FLEAL-150/2ZS

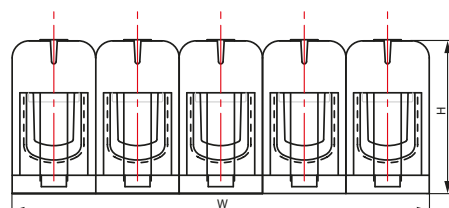

FLEAL-95/3, FLEAL-150/3



FLEAL-95/3K, FLEAL-150/3K



FLEAL-95/3ZS, FLEAL-150/3ZS

Fővezetéki leágazó sorkapocs nyitható fedéllel

TRACON	xP	mm ²	mm ²	mm ²	mm ²	U _i	I _n	X	
		IN	OUT	OUT	OUT			IN	OUT
FLS016	1P	3×16	3×16	4×10	4×6	1.000 V AC/DC	80 A	3×M6	4×M4
FLS050	1P	1×50	1×35	6×25	6×16	1.000 V AC/DC	125 A	1×M12	6×M6
FLS070	1P	1×70	1×50	6×25	6×16	1.000 V AC/DC	160 A	1×M14	6×M6
FLS0120	1P	1×120	1×95	2×35	2×25	1.000 V AC/DC	250 A	1×M16	2×M10
				5×25	5×16			5×M6	4×M8
				4×16	4×10				
FLS0150	1P	1×150	1×120	2×35	2×25	1.000 V AC/DC	400 A	1×M20	2×M10
				5×25	5×16			5×M6	4×M8
				4×16	4×10				
FLS08X25	1P	 (mm) (8×25)	-	2×35	2×25	1.000 V AC/DC	500 A	2×M8	2×M10
				5×25	5×16			5×M6	4×M8
				4×16	4×10				
FLS050-3P	3P	1×50	1×35	6×16	6×10	690 V AC/DC	175 A	M10	6×M6
		1×50	1×35	6×16	6×10			M10	6×M6
		1×50	1×35	6×16	6×10			M10	6×M6
FLS035-4P	4P	1×35	1×25	5×10	5×6	690 V AC/DC	125 A	M5	5×M4
		1×35	1×25	2×25	2×16			2×M5	5×M4
		1×35	1×25	5×10	5×6			M5	2×M5
		1×35	1×25	2×25	2×16			M5	5×M4
		1×35	1×25	5×10	5×6			M5	2×M5
		1×35	1×25	6×25	6×16			M5	6×M5
		1×35	1×25	4×16	4×10			M5	4×M5



RELEVANT STANDARD
IEC 60947-7-1

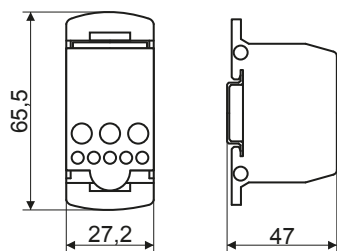

FLS016

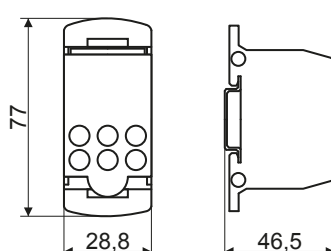

FLS050
FLS070

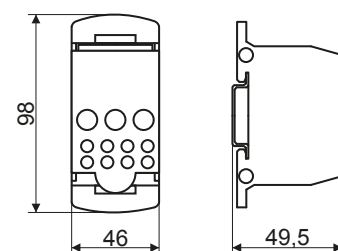

FLS0120
FLS0150
FLS08X25

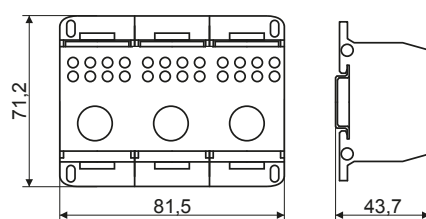

FLS050-3P

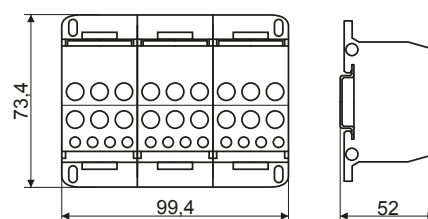

FLS035-4P

Moduláris elosztóblokk nyitható fedéllel

TRACON	xP	mm ²	mm ²	mm ²	mm ²	In		X	
FLS025-2P7	2P	1×25	1×25	3×10 3×16	3×6 3×10	100 A		M5	3×M4 3×M5
FLS025-2P11	2P	2×25	2×25	4×10 5×16	4×6 5×10	100 A		M5	4×M4 5×M5
FLS025-2P15	2P	2×25	2×25	6×10 7×16	6×6 7×10	100 A		M5	6×M4 7×M5
FLS016-4P6	4P	1×16	1×10	3×10	3×6	80 A		1×M4	5×M4
FLS016-4P11	4P	3×16	3×10	8×10	8×6	80 A		3×M4	8×M4
FLS016-4P16	4P	4×16	4×10	12×10	12×6	80 A		4×M4	12×M4

400 V AC	IP 20	35×7.5	Ta -20...+75 °C	Cu	PA6.6	500 V	V2 UL94
-----------------	--------------	--------	------------------------	----	-------	--------------	----------------

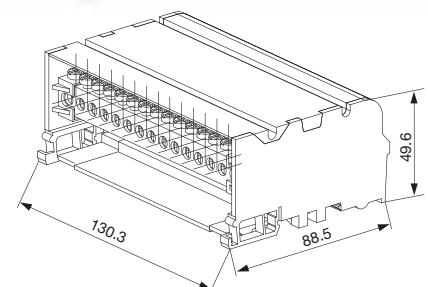
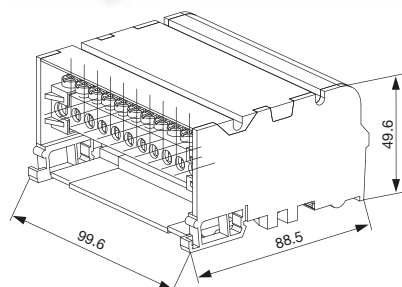
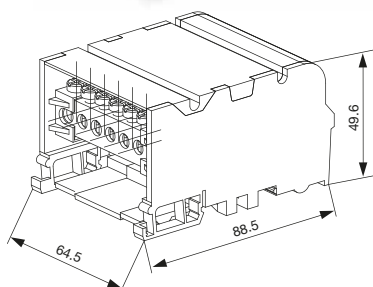
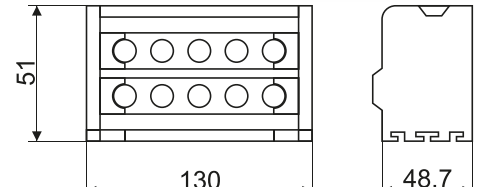
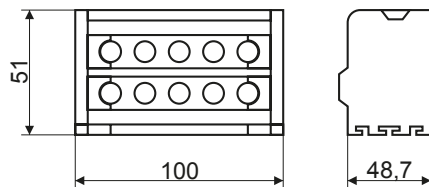
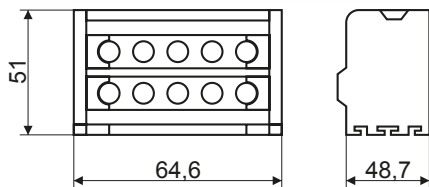
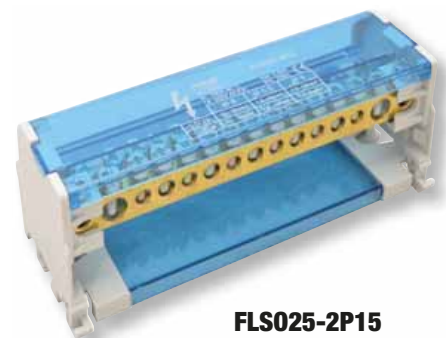
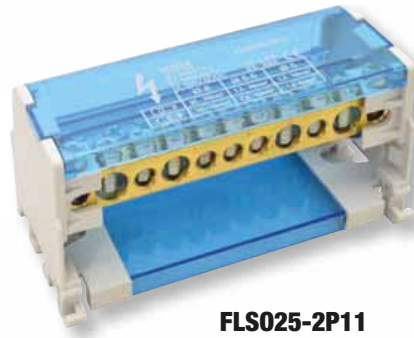

Moduláris toldó kapocs nyitható fedéllel

TRACON	xP	mm ²	mm ²	mm ²	mm ²	U _i	I _n	X	OUT	
FLS0T35	1P	1×35	1×35	1×35	1×35	1.000 V AC/DC	125 A		M10	M10
FLS0T95	1P	1×95	1×70	1×95	1×70	1.000 V AC/DC	250 A		M16	M16
FLS0T95L	1P	1×95	1×95	1×95	1×95	690 V AC/DC	250 A		M10	M10

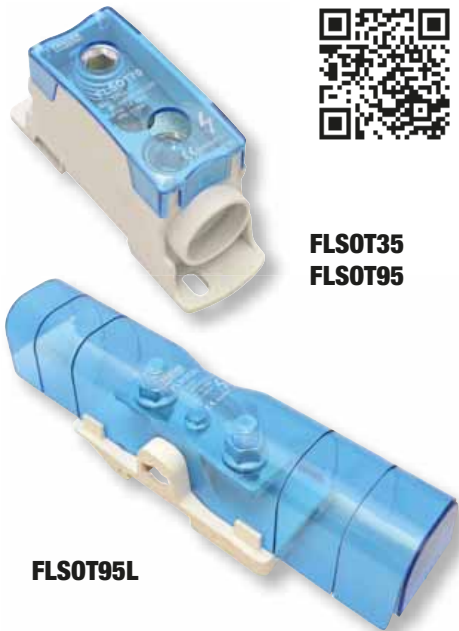

FLS0T35
FLS0T95

FLS0T95L

V2
UL94

400
V AC

IP
20

35×7.5

Cu-sn

PA6.6

Ta
-20..+75 °C

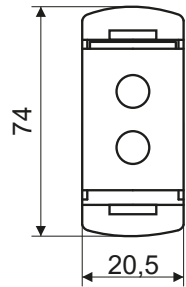

FLS0T35

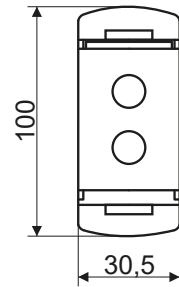
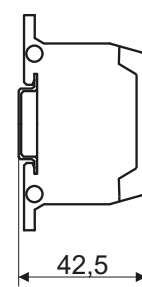

FLS0T95

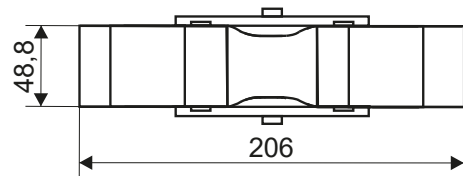
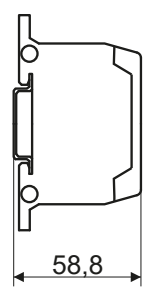

FLS0T95L

LED

FÉNYFORRÁSOK SAMSUNG CHIPPEL











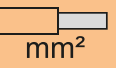

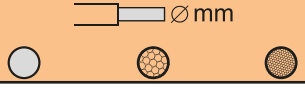







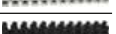

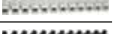

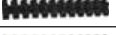

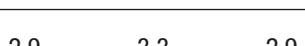

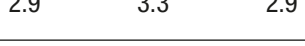





5

YEARS
WARRANTY

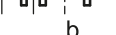
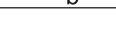
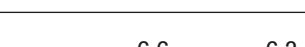
E/87

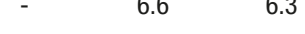
H-profil kivitelű flexibilis sorozatkapcsok

Hagyományos kiviteli változat

Profil	TRACON		 mm ²	X 	In		 ∅ mm	d ₁ (mm)	a (mm)	b (mm)	c (mm)	e (mm)
S3A-H			2.5	× 12	16 A		1.9	3	11	93.2	11	7.5
SF3A-H			2.5	× 12	16 A		2.2	3	11	93.2	11	7.5
S5A-H			4	× 12	25 A		2.4	3.2	13	114.8	13	9.7
SF5A-H			4	× 12	25 A		2.7	3.2	13	114.8	13	9.7
S10A-H			6	× 12	40 A		2.9	4.2	15.3	131.5	15.3	11.1
SF10A-H			6	× 12	40 A		3.3	4.2	15.3	131.5	15.3	11.1
S15A-H			10	× 12	50 A		2.9	4.5	16.6	137.3	22.5	11.5
SF15A-H			10	× 12	50 A		3.3	4.5	16.6	137.3	22.5	11.5
S30A-H			16	× 12	63 A		3.7	5.5	19.2	169	19.2	14.5
SF30A-H			16	× 12	63 A		4.2	5.5	19.2	169	19.2	14.5
S60A-H			25	× 12	80 A		-	6.6	24.4	191	24.4	16
SF60A-H			25	× 12	80 A		6.6	6.6	24.4	191	24.4	16

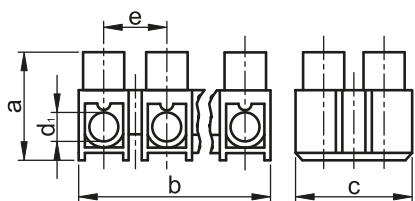

 **Cu**

 **450 V**

 **Nm**
0.4 – 0.8

 **PP**











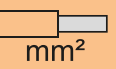

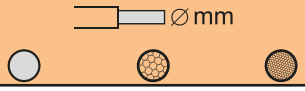





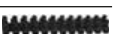

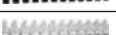
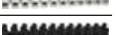

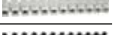



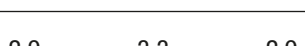

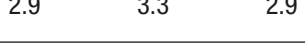





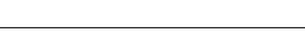

 **Ta**
-20..+75 °C

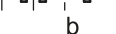
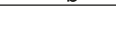



RELEVANT STANDARD
EN 60998-1
EN 60998-2-1

H-profil kivitelű flexibilis sorozatkapcsok

Nyomólemezkes kiviteli változat

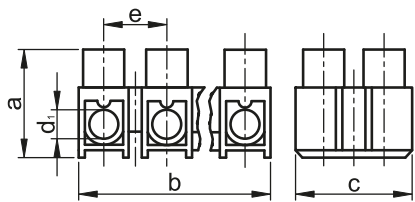
Profil	TRACON		 mm ²	X 	In		 ∅ mm	d ₁ (mm)	a (mm)	b (mm)	c (mm)	e (mm)
S3A-H-L			2.5	× 12	16 A		1.9	3	11	93.2	11	7.5
SF3A-H-L			2.5	× 12	16 A		2.2	3	11	93.2	11	7.5
S5A-H-L			4	× 12	25 A		2.4	3.2	13	114.8	13	9.7
SF5A-H-L			4	× 12	25 A		2.7	3.2	13	114.8	13	9.7
S10A-H-L			6	× 12	40 A		2.9	4.2	15.3	131.5	15.3	11.1
SF10A-H-L			6	× 12	40 A		3.3	4.2	15.3	131.5	15.3	11.1
S15A-H-L			10	× 12	50 A		3.7	4.5	16.6	140	22.5	11.5
SF15A-H-L			10	× 12	50 A		4.2	4.5	16.6	140	22.5	11.5
S30A-H-L			16	× 12	63 A		3.7	5.5	19.2	169	19.2	14.5
SF30A-H-L			16	× 12	63 A		4.2	5.5	19.2	169	19.2	14.5
S60A-H-L			25	× 12	80 A		-	6.6	24.4	191	24.4	16
SF60A-H-L			25	× 12	80 A		6.6	6.6	24.4	191	24.4	16



 **Cu**

 **450 V**

 **Nm**
0.4 – 0.8



























 **PP**

 **Ta**
-20..+75 °C



RELEVANT STANDARD
EN 60998-1
EN 60998-2-1

U-profil kivitelű flexibilis sorozatkapcsok

Profil	TRACON		mm^2	X 	I_n		mm	d_1 (mm)	a (mm)	b (mm)	c (mm)	e (mm)	
S3A-U			2.5	× 12	16 A	1.9	2.2	2.3	3	10.8	91.4	15.6	7.6
S5A-U			4	× 12	25 A	2.4	2.7	2.9	3.3	12.8	112.5	15.5	9.5
S10A-U			6	× 12	40 A	2.9	3.3	2.9	4.2	15	128	20.6	10.8
SF10A-U			6	× 12	40 A	2.9	3.3	2.9	4.2	15	128	20.6	10.8
S15A-U				× 12		2.9	2.9	3.3	4.5	16.6	137.3	22.5	12
SF15A-U			10	× 12	50 A	2.9	2.9	3.3	4.5	16.6	137.3	22.5	12
SK15A-U			10	× 12	50 A	2.9	2.9	3.3	4.5	16.6	137.3	22.5	12
SP15A-U			10	× 12	50 A	2.9	2.9	3.3	4.5	16.6	137.3	22.5	12
S30A-U			16	× 12	63 A	3.7	4.2	3.9	5.6	19	164.5	25.3	19
SF30A-U			16	× 12	63 A	3.7	4.2	3.9	5.6	19	164.5	25.3	19
S60A-U			25	× 12	80 A	–	6.6	6.3	6.6	24	185.5	29.2	15.8
SF60A-U			25	× 12	80 A	–	6.6	6.3	6.6	24	185.5	29.2	15.8

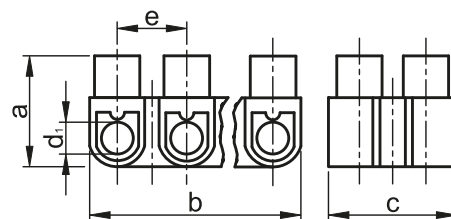

RELEVANT STANDARD

EN 60998-1
EN 60998-2-1

FIMKO IEC6E-CB CERTIFICATE NO.
FI748, FI876, FI952

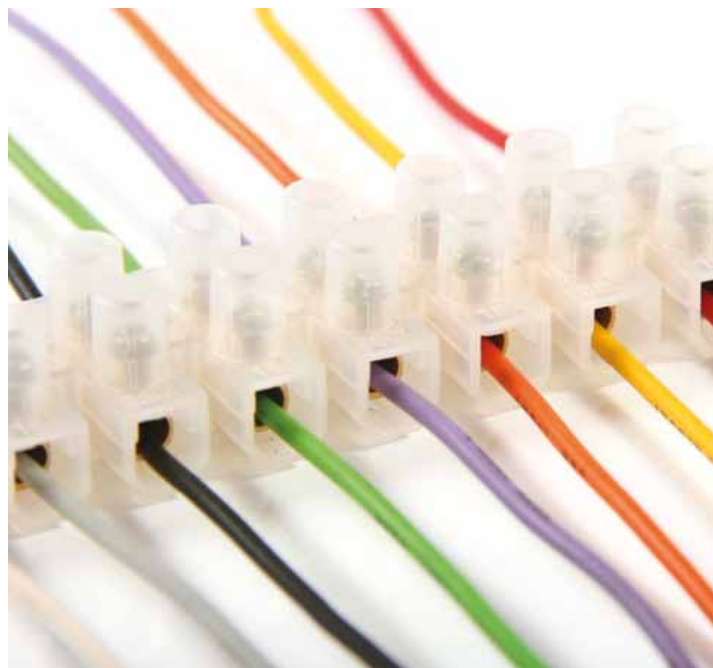

OLVASSA BE A KÓDOT!

- Nézze meg újdonságainkat
- Legyen naprakész



Kínálatunk gyorsan és folyamatosan fejlődik!
Katalógusunk a 2021. áprilisi állapotot tükrözi.

Naprakész információért
látogasson el honlapunkra!

TSKD csavarnélküli (rugós) sorozatkapcsok

Elsősorban vezérlő, szabályozó áramköröknél, a 0.08 mm² - 6.0 mm² keresztmetszetű vezetékek gyors és jó minőségű, megbízható csatlakoztatására tervezték a csavarnélküli sorozatkapcsokat. A kapcsokba csatlakoztatni lehet az előkészítés nélküli merev, továbbá az érvéghüvellyel vagy csapos saruval ellátott, hajlékony és különlegesen hajlékony vezetékeket.

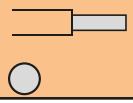
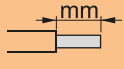
Az áramvezető elemek elhelyezésére szolgáló magas hőállóságú, nagy mechanikai szilárdságú, UL94-V0 szerinti önkioltó tulajdonságú, és jó villamos adatokkal rendelkező poliamidból készült műanyagház kialakítása olyan, hogy a sorozatkapcsokat csavarral lehet rögzíteni bármilyen felületre.

TRACON		U _n	I _n	 mm ²	W (mm)	L (mm)	H (mm)	 mm		
TSKD1,5		400 V	18 A	1.5	5	25.5	17.5	6	VLD1,5	SFD1,5
TSKD2,5		500 V	24 A	0.08-4	6	28	17	7	VLD2,5	SFD2,5
TSKD4		690 V	32 A	0.08-6	7	33.7	23	8	VLD4	SFD4
TSKD1,5D		400 V	18 A	2 × (0.08-1.5)	8	25.5	17.5	7	VLD1,5	SFD1,5
TSKD2,5D		500 V	24 A	2 × (0.08-4)	10	28	17	7	VLD2,5	SFD2,5
TSKD4D		690 V	32 A	2 × (0.08-6)	12	33.7	23	8	VLD4	SFD4

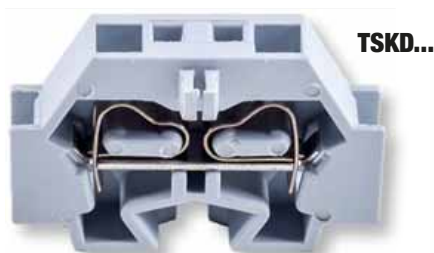
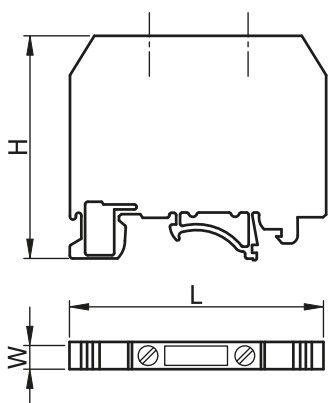

Kiegészítők

TRACON	
TSKDRE	Adapter TSKD sorozat sínre pattintásához

TRACON	
VLD1,5	Véglemez TSKD1,5-TSKD1,5D-hez
VLD2,5	Véglemez TSKD2,5-TSKD2,5D-hez
VLD4	Véglemez TSKD4-TSKD4D-hez

TRACON	
SFD1,5	Oldalsó sínfésű TSKD1,5 - TSKD1,5D-hez (2 modul)
SFD2,5	Oldalsó sínfésű TSKD2,5 - TSKD2,5D-hez (2 modul)
SFD4	Oldalsó sínfésű TSKD4 - TSKD4D-hez (2 modul)



OLVASSA BE A KÓDOT!

- Nézze meg újdonságainkat
- Legyen naprakész

Kínálatunk gyorsan és folyamatosan fejlődik!
Katalógusunk a 2021. áprilisi állapotot tükrözi.
Naprakész információért
látogasson el honlapunkra!

TSKA ipari sorozatkapcsok

A TSKA típusú sorozatkapocs gyártmánycsalád több egymástól elszigetelt csavaros csatlakozókapocs-egységet tartalmaz. Elsősorban ipari- és hasonló célra szolgáló mérő-, vezérlő-, és energiaátviteli elosztószekrények áramköreibben használható. A sorozatkapcsok kör keresztmetszetű vezetékek csatlakoztatására alkalmazhatók. Magas hőállóságú, nagy mechanikai szilárdságú, UL94-V0 szerinti önkioltó tulajdonságú, PA6.6 készült műanyagház kialakítása olyan, hogy a sorozatkapcsokat az EN 50022 szabvány szerinti szerelősínekre („kalapsín” vagy „C” sín) lehet rögzíteni. Alkalmazási hőmérséklet: -30 °C ... +90 °C.



Általános célú sorozatkapcsok

Szokásos felhasználásban a sorozatkapocs max. 25 mm² keresztmetszetű fázisvezetők csatlakoztatására szolgál. A műanyagház egyik oldala nyitott. A kapocssor végén elhelyezkedő sorkapocs a VL jelű véglemez tartozékkal zárható le.



Nagyáramú sorozatkapcsok

A sorozatkapcsok 35-185 mm² keresztmetszetű fázisvezetők csatlakoztatására használhatók. A hüvelykapcsok préselt fémkeretből készülnek. A sorozatkapcsok műanyag háza mindkét oldalról zárt.



Nullavezető sorozatkapcsok

Kialakításában megegyezik az általános célú sorozatkapoccsal, ugyanakkor a műanyagház kék színe miatt a nullavezető bekötésére célszerű alkalmazni, így lehetővé válik a fázisvezető és a nullavezető vizuális megkülönböztetése.



Nagyáramú nullavezető sorozatkapcsok

Kialakításában megegyezik az általános célú nagyáramú sorozatkapoccsal, ugyanakkor a műanyagház kék színe miatt a nullavezető bekötésére célszerű alkalmazni, így lehetővé válik a fázisvezető és a nullavezető vizuális megkülönböztetése.



Védővezető sorozatkapcsok

A zöld/sárga vezetők és a sorozatkapcsokat rögzítő földelt szerelősín közötti villamos és mechanikai kapcsolat kialakítására alkalmazható. A sorozatkapcsok PEN és PE vezetők csatlakoztatására alkalmasak.



Emeletes sorozatkapcsok

Két egymástól független áramkör vezetékeinek csatlakoztatására alkalmasak. A két, egymás feletti szinten elhelyezett csatlakozókapcsok a műanyagház kedvező kialakítása következtében csavarhúzóval könnyen és kényelmesen kezelhetők. Helyhiány esetén hasznosak.



Többkapcsos sorozatkapcsok

Elsősorban akkor célszerű alkalmazni, amikor az azonos áramkörhöz tartozó egymástól eltérő szerkezetű, típusú vagy keresztmetszetű vezetékek összekötésére van szükség.



Biztosítós sorozatkapcsok

Különböző áramerősséggel rendelkező üvegcsöves biztosítók aljzata, amik a biztosítók állapotáról egy LED fényforráson keresztül visszajelzést adnak, így egy esetleges probléma könnyedén beazonosítható.
(5×20mm-es biztosítékokhoz)



Mérő sorozatkapcsok

A villamos rövidzáró sín zárva vagy nyitva tartása mellett – egyszerűen lehetséges a mérőműszerek párhuzamos vagy soros csatlakoztatása a mérendő áramkörbe. A TSKA6S-nél a mérőhüvely egyaránt szolgál a vezeték megszorítására és a vizsgálgódu-gasz rögzítésére is.



Szakaszolható sorozatkapcsok

Max. 16 A névleges áram vezetésére alkalmas. A szakaszolóképes alkalmas max. 500 V-os névleges feszültségű áramkör ellenőrzés céljára történő bontására vagy üzemszerű szakaszolására.



TÜV MEEI TEST DOCUMENTATION
28211721 001

TÜV MEEI TEST DOCUMENTATION
28211719 001

RELEVANT STANDARD
EN 60947-7-1
EN 60947-7-2

Tartozékok

SF sínfésűk

A sorozatkapcsok vezetékterben való összekötésére használható. A sínfésű két-, három- és tíztagú kivitelben áll rendelkezésre. Közösítő része műanyag burkolatú a villamos szilárdság és a véletlen érintés elleni védelem biztosítása céljából.

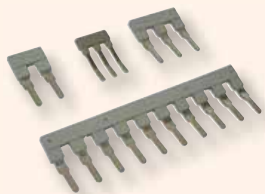

USF sínfésűk

A sorozatkapocs egységek középponton történő összekötésére szolgál. Két-, három- és tíztagú kivitelben áll rendelkezésre TSKA50-es méretig.



VL véglemezek

A kapocssor végeinek lezárására szolgál. Különböző méret nagyságú sorkapcsok egymás mellett történő elhelyezésekor a névleges feszültségnek megfelelő szigetelési távolságot és véletlen megérintés elleni védelmet biztosít.



HL áthidalók

Nem egymás mellett elhelyezkedő kapocssorok összekötésére is alkalmasak. A csavarfejen található szigetelő test a véletlen érintés ellen biztosít védeltséget. Tíznel több kapocssor összekötése a lemezek átfedésével valósítható meg.

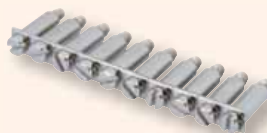

EL áramkör elválasztó lapok

Az utólag is behelyezhető két szomszédos átkötőhíd vagy áthidaló lemez villamos, és egyben vizuális elkülönítésére szolgál.

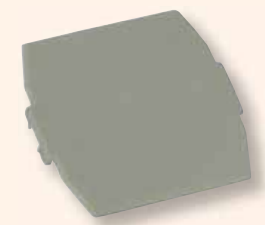

SZEL szegmens elválasztó lapok

A kapocssorok villamos és vizuális elválasztására szolgál.



RE rögzítő elemek

A sorozatkapcsok szerelősinre (35/7.5 mm-es „kalapsín” vagy 32/15 mm-es „C sín”) való rögzítését, megtámasztását teszi lehetővé. Alkalmazásuk a kapocssor mindkét végén ajánlott.

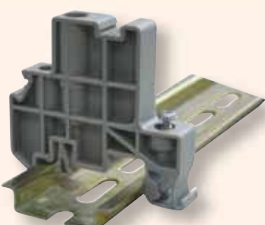

KJ-A kapocssor-jelölő

Az RE1 és RE2 rögzítő elemre pattintva kapocssorok jelölésére alkalmas úgy, hogy a 44 x 7 mm-es jelölőlapkát a megfelelően kialakított horonyba helyezzük.

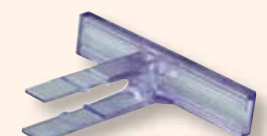

J jelölőmatricák

A 4 méretben rendelkezésre álló jelölőmatricák a meglévő J.. jelölőlapkákhoz használhatók. A kiserelés A4 terjedelmű, az elérhető jelölések: 1-100, L1, L2, L3, R, S, T, N, stb. Típusválasztékot lásd a Webáruházban!



J jelölőlapkák

A feliratozható jelölőlapkák a sorkapcsok azonosítását teszik lehetővé. A jelölőket 4 különböző szélességi méretben és 10 modulós egységekben forgalmazzuk.



TÜV MEEI TEST DOCUMENTATION
28211721 001

TÜV MEEI TEST DOCUMENTATION
28211719 001

RELEVANT STANDARD
EN 60947-7-1
EN 60947-7-2



OLVASSA BE A KÓDOT!







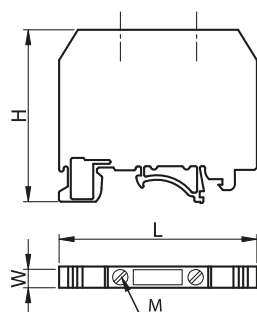
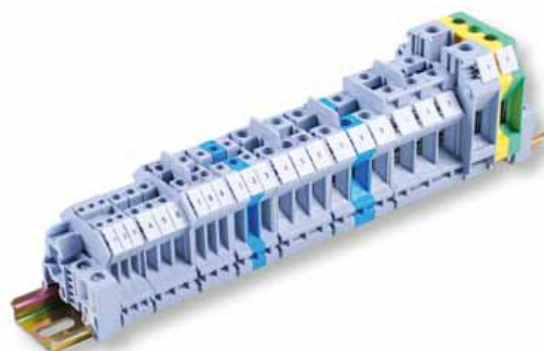





- Nézze meg újdonságainkat
- Legyen naprakész

Kínálatunk gyorsan és folyamatosan fejlődik!
Katalógusunk a 2021. áprilisi állapotot tükrözi.
Naprakész információért
látogasson el honlapunkra!

TRACON		U_n	I_n			W (mm)	L (mm)	H (mm)	M (mm)	
TSKA1,5	Általános	500 V	17.5 A	0.14-1.5	0.14-1.5	4.3	43	41	M2	5
TSKA2,5	Általános	800 V	32 A	0.2-4	0.2-2.5	5.5	43	41,2	M3	8
TSKA4	Általános	800 V	41 A	0.2-6	0.2-4	6.5	43	46	M3	8
TSKA6	Általános	800 V	57 A	0.2-10	0.2-6	8.5	43	46	M4	10
TSKA10	Általános	800 V	76 A	0.5-16	0.5-10	10.2	43	46	M4	10
TSKA16	Általános	800 V	101 A	2.5-25	4-16	12.2	43	52.5	M4	11
TSKA35	Általános	1000 V	150 A	0.75-50	0.75-35	15.2	50	61	M6	16
TSKA50	Általános	1000 V	150 A	16-50	25-50	20.5	71	76	M6	24
TSKA70	Általános	1000 V	192 A	25-70	25-70	20.2	70.7	76,5	M6	23,5
TSKA95	Általános	1000 V	232 A	25-95	35-95	25	83	90	M8	33
TSKA150	Általános	1000 V	309 A	35-150	50-150	31	100	119	M10	40
TSKA240	Általános	1000 V	415 A	70-240	70-240	36	100	131.5	M12	40
TSKA1,5-K	Nullavezető	500 V	17.5 A	0.14-1.5	0.14-1.5	4.3	43	41	M2	5
TSKA2,5-K	Nullavezető	800 V	32 A	0.2-4	0.2-2.5	5.5	43	41,2	M3	8
TSKA4-K	Nullavezető	800 V	41 A	0.2-6	0.2-4	6.5	43	46	M3	8
TSKA6-K	Nullavezető	800 V	57 A	0.2-10	0.2-6	8.3	43	46	M4	10
TSKA10-K	Nullavezető	800 V	76 A	0.5-16	0.5-10	10.5	43	46	M4	10
TSKA16-K	Nullavezető	800 V	101 A	2.5-25	4-16	12.5	43	52.5	M4	11
TSKA35-K	Nullavezető	1000 V	150 A	0.75-50	0.75-35	15.7	51	62	M6	16
TSKA50-K	Nullavezető	1000 V	150 A	16-50	25-50	20.5	71	76	M6	24
TSKA70-K	Nullavezető	1000 V	192 A	25-70	25-70	20.2	70.7	76,5	M6	23,5
TSKA95-K	Nullavezető	1000 V	232 A	25-95	35-95	25	83	90	M8	33
TSKA150-K	Nullavezető	1000 V	309 A	35-150	50-150	31.5	101	112	M10	40
TSKA240-K	Nullavezető	1000 V	415 A	70-240	70-240	36	100	131.5	M12	40
TSKA1,5JD	Védővezető	500 V	17.5 A	0.14-1.5	0.14-1.5	4.3	43	41	M2	5
TSKA2,5JD	Védővezető	-	32 A	0.2-4	0.2-2.5	5.5	42.5	45.5	M3	8
TSKA4JD	Védővezető	-	41 A	0.2-6	0.2-4	6.5	43	46	M3	8
TSKA6JD	Védővezető	-	57 A	0.2-10	0.2-6	8.5	43	46	M4	10
TSKA10JD	Védővezető	-	76 A	0.5-16	0.5-10	10.5	43	45.5	M4	10
TSKA16JD	Védővezető	-	101 A	2.5-25	4-16	12.5	43	52.5	M4	11
TSKA35JD	Védővezető	-	150 A	0.75-50	0.75-35	16	55	51	M6	16
TSKA50JD	Védővezető	-	150 A	16-50	25-50	20.5	71	77	M6	24
TSKA70JD	Védővezető	-	192 A	25-70	25-70	20.2	70.7	76,5	M6	23,5
TSKA95JD	Védővezető	-	230 A	95-95	35-95	25.3	83.3	89.7	M8	23,5
TSKA2,5/2	Emeletes	500 V	32 A	0.2-4	0.2-2.5	5.5	56.5	62	M3	8
TSKA2,5/2S	Emeletes	500 V	24 A	0.2-4	0.2-4	5.5	62.1	47	M3	6
TSKA4/2	Emeletes	500 V	32 A	0.2-4	0.2-4	6.5	56.5	61	M3	8
TSKA4/3	Háromkapcsos	500 V	32 A	0.2-4	0.2-4	6.5	50	46	M3	8
TSKA4/4	Négykapcsos	690 V	32 A	0.2-6	0.2-4	6.5	63.5	46	M3	8
TSKA10/3	Háromkapcsos	800 V	65 A	0.5-16	0.5-10	10	57	57.8	M4	5
TSKA4LEV	Szakaszolható	500 V	16 A	0.2-4	0.2-4	6.5	51.5	47	M3	8
TSKA6S	Mérő	400 V	57 A	0.5-10	0.5-6	8.5	72.5	51	M4	13
TSKA6S/2	Mérő	500 V	57 A	0.5-10	0.5-6	8.5	61.5	58	M3	8
TSKA4B	Biztosítós	800 V	6.3 A	0.2-4	0.2-4	8	73.6	55	M3	8
TSKA16B	Biztosítós	800 V	6.3 A	0.5-16	0.5-16	12.2	62.6	57.8	M4	9



	2 modul	3 modul
(1)	USF35-2	USF35-3
(2)	USF50-2	USF50-3
(3)	A KJ-A kapocsor-jelölő az RE1 rögzítőelemre helyezhető	

												
0.4	USF1,5	-	-	-	VL1,5	-	-	SZEL101	J4	RE1	TSKA1,5	
0.5	USF2,5	SF102	SF103	SF100	VL4/10	HL2,5	EL102	SZEL101	J5	RE1	TSKA2,5	
0.5	USF4	SF112	SF113	SF110	VL4/10	HL4	EL102	SZEL101	J6	RE1	TSKA4	
1.2	USF6	SF122	SF123	SF120	VL4/10	HL6	EL102	SZEL101	J8	RE1	TSKA6	
1.2	USF10	SF132	SF133	SF130	VL4/10	HL10	EL102	SZEL101	J10	RE1	TSKA10	
1.2	USF16	-	-	SF140	VL16	-	EL102	SZEL101	J10	RE1	TSKA16	
2.5	USF35 ⁽¹⁾	-	-	SF150	-	-	EL102	-	J10	RE1	TSKA35	
2.5	-(²)	-	-	-	-	-	-	-	J10	RE2	TSKA50	
1.8	USF50***	-	-	-	-	-	-	-	J10	RE2	TSKA70	
3.5	-	-	-	-	-	-	-	-	J10	RE2	TSKA95	
4.0	-	-	-	-	-	-	-	-	J10	RE2	TSKA150	
14	-	-	-	-	-	-	-	-	J10	RE2	TSKA240	
0.4	USF1,5	-	-	-	VL4/10	-	-	SZEL101	J4	RE1	TSKA1,5-K	
0.5	USF2,5	SF102	SF103	SF100	VL4/10	HL2,5	EL102	SZEL101	J5	RE1	TSKA2,5-K	
0.5	USF4	SF112	SF113	SF110	VL4/10	HL4	EL102	SZEL101	J6	RE1	TSKA4-K	
1.2	USF6	SF122	SF123	SF120	VL4/10	HL6	EL102	SZEL101	J8	RE1	TSKA6-K	
1.2	USF10	SF132	SF133	SF130	VL4/10	HL10	EL102	SZEL101	J10	RE1	TSKA10-K	
1.2	USF16	-	-	SF140	VL16	-	EL102	SZEL101	J10	RE1	TSKA16-K	
2.5	USF35 ⁽¹⁾	-	-	SF150	-	-	EL102	-	J10	RE1	TSKA35-K	
2.5	-(²)	-	-	-	-	-	-	-	J10	RE2	TSKA50-K	
2.5	USF50***	-	-	-	-	-	-	-	J10	RE2	TSKA70-K	
3.5	-	-	-	-	-	-	-	-	J10	RE2	TSKA95-K	
4.0	-	-	-	-	-	-	-	-	J10	RE2	TSKA150-K	
14	-	-	-	-	-	-	-	-	J10	RE2	TSKA240-K	
0.5	-	-	-	-	-	-	-	-	J5	RE1	TSKA1,5JD	
0.5	-	-	-	-	-	-	-	-	J6	RE1	TSKA2,5JD	
1.2	-	-	-	-	-	-	-	-	J8	RE1	TSKA4JD	
0.4	-	-	-	-	-	-	-	-	J4	RE1	TSKA6JD	
1.2	-	-	-	-	-	-	-	-	J10	RE1	TSKA10JD	
1.2	-	-	-	-	-	-	-	-	J10	RE1	TSKA16JD	
2.5	-	-	-	-	-	-	-	-	J10	RE1	TSKA35JD	
2.5	-	-	-	-	-	-	-	-	J10	RE2	TSKA50JD	
2.5	-	-	-	-	-	-	-	-	J10	RE2	TSKA70JD	
3.5	-	-	-	-	-	-	-	-	J10	RE2	TSKA95JD	
0.5	USF4/2	-	-	SF180	VL3/5	-	EL101	-	J5	RE1	TSKA2,5/2	
0.4	USF4/2	SF102	SF103	SF100	VL2,5/2S	HL2,5	EL102	-	J5	RE1	TSKA2,5/2S	
0.5	USF4	SF112	SF113	SF110	VL3/5	HL4	EL101	-	J6	RE1	TSKA4/2	
0.5	USF4	SF112	SF113	SF110	VL4/3	HL4	EL102	-	J6	RE1	TSKA4/3	
0.5	USF4	SF112	SF113	SF110	VL4/4	HL4	EL101	-	J6	RE1	TSKA4/4	
1.2	USF10	SF132	SF133	SF130	-	-	EL100	-	J5	RE1	TSKA10/3	
0.5	-	SF112	SF113	SF110	-	-	-	-	J6	RE1	TSKA4LEV	
1.2	-	-	-	-	VL6S	-	EL105	SZEL105	J8	RE1	TSKA6S	
0.5	USF6S/2	SF122	SF123	SF120	VL6S/2	-	EL104	-	J8	RE1	TSKA6S/2	
0.5	-	-	-	-	-	-	-	-	J8	RE1	TSKA4B	
1.2	USF16	-	-	-	-	-	-	-	J8	RE1	TSKA16B	

***Központi sínfésű 2-3 modul

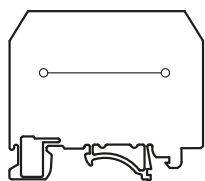
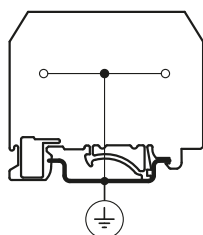
Általános,
nullavezető

Védővezető

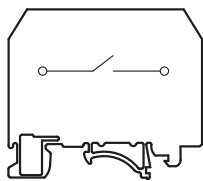
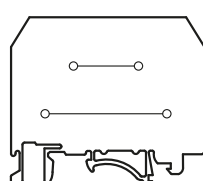
Mérő,
leválasztó

Emeletes

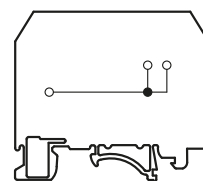
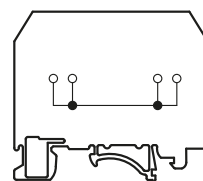
Három-
kapcsos

Négykapcsos

TSKC csavarnélküli (rugós) sorozatkapcsok

Elsősorban vezérlő, szabályozó áramköröknél, a 0.2 mm² - 16 mm² keresztmetszetű vezetékek gyors és jó minőségű, megbízható csatlakoztatására tervezték a csavarnélküli sorozatkapcsokat. A kapcsokba csatlakoztatni lehet az előkészítés nélküli merev, továbbá az érvéghüvellyel vagy csapos saruval ellátott, hajlékony és különlegesen hajlékony vezetékeket.

Az áramvezető elemek elhelyezésére szolgáló magas hőállóságú, nagy mechanikai szilárdságú, UL94-V0 szerinti önkioltó tulajdonságú, és jó villamos adatokkal rendelkező PA6.6 poliamidból készült műanyagház kialakítása olyan, hogy a sorozatkapcsokat az EN 50022 szabvány szerinti szerelősínre („kalapsín”) lehet rögzíteni.



Általános célú sorozatkapcsok

2.5 mm² - 16 mm² keresztmetszetű vezetékek helytakarékos, felülről történő csatlakoztatását teszik lehetővé. Az érintkezést a sorkapcsban lévő rugó biztosítja. A kötés oldása egy csavarhúzó segítségével, a rugó benyomásával történhet.

TSKC..D



Nullavezető sorozatkapcsok

Kialakításában megegyezik az általános célú sorozatkapocccsal, ugyanakkor a műanyagház kék színe miatt a nullavezető bekötésére célszerű alkalmazni, így lehetővé válik a fázisvezető és a nullavezető vizuális megkülönböztetése.

TSKC..D-K



Védővezető sorozatkapcsok

A zöld/sárga vezetők és a sorozatkapcsokat rögzítő földelt szerelősín közötti villamos és mechanikai kapcsolat kialakítására alkalmazható. A sorozatkapcsok PEN és PE vezetők csatlakoztatására alkalmasak. Konstrukciójuk szerint lehetnek általános, három, ill. négykapcsos kialakításúak.

TSKC..JDD



Emeletes sorozatkapcsok

2-3 egymástól független áramkör vezetékeinek csatlakoztatására alkalmasak. A két, egymás feletti szinten elhelyezett csatlakozókapcsok a műanyagház kedvező kialakítása következtében csavarhúzó segítségével könnyen és kényelmesen kezelhetők.



Háromkapcsos sorozatkapcsok

Elsősorban akkor célszerű alkalmazni, amikor az azonos áramkörhöz tartozó egymástól eltérő szerkezetű, típusú, vagy keresztmetszetű vezetékek összekötésére van szükség. A kialakítás lehetővé teszi 3 vezető azonos feszültségszintre való csatlakoztatását. Nullavezető kék színű kivitelben is rendelhető.



Négykapcsos sorozatkapcsok

Célszerű alkalmazásra, amikor az azonos áramkörhöz tartozó egymástól eltérő szerkezetű, típusú, vagy keresztmetszetű vezetékek összekötésére van szükség. A kialakítás lehetővé teszi 4 vezető azonos feszültségszintre való csatlakoztatását. Nullavezető kék színű kivitelben is rendelhető.



Biztosítós sorozatkapcsok

Különböző áramerősséggel rendelkező üvegcsöves biztosítók aljzata, amik a biztosítók állapotáról egy LED fényforráson keresztül visszajelzést adnak, így egy esetleges probléma könnyedén beazonosítható. (5x20mm-es biztosítékokhoz)

RELEVANT STANDARD
EN 60947-7-1

RELEVANT STANDARD
EN 60947-7-2



Tartozékok

AHC..., SFC.. átkötőhidak

2 pólusú kivitelben állnak rendelkezésre, külön a szomszédos elemek (SFC..) összekapcsolására és külön minden második elem (AHC..) összekapcsolására.

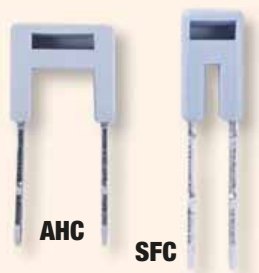
**J jelölőmatricák**

A 4 méretben rendelkezésre álló jelölőmatricák a meglévő J.. jelölőlapkákhoz használhatók. A kiszérelés A4 terjedelmű, az elérhető jelölések: 1-100, L1, L2, L3, R, S, T, N, stb. Típusválasztékot lásd a Web áruházban!

**REC1, REC2, REC3 rögzítőelem**

A sorozatkapcsok szerelősínre (35/7.5 mm-es „kalapsín” vagy 32/15 mm-es „C sín”) való rögzítését, megtámasztását teszi lehetővé. Alkalmazása a kapocssor mindkét végén ajánlott.

**TSKC-EJ emeletes sorkapocs jelölőlapkát tartó állványzat**

Segítségével külön lehet jelölést biztosítani a 2-3 emelettel rendelkező sorozatkapcsok különböző emeleteihez is.

**VLC véglemezek**

A kapocssor végein, illetve különböző méretű sorkapcsok egymás mellett történő elhelyezésekor a névleges feszültségnek megfelelő szigetelési távolságot és véletlen megérintés elleni védelmet biztosít.

**SJ9 Szerelősínre rögzíthető jelölő talp és állvány**

A szerelősínre, vagy „kalapsínre” pattintható jelölő, ami alkalmas a sín, vagy sínszakasz jelölésére a 13/7 (SJ15/SJ9) mm-es papír feliratozás utáni, az arra kialakított horonyba helyezésével.

**TSKCJS jelölőlapka**

Segítségével a sorkapcsok feliratozhatóak J jelölőmatricával. Alkalmazásával mind a telepítés, mind a későbbi szerelés során a beazonosítás leegyszerűsödik.

**SJ15 Szerelősínre rögzíthető jelölő talp és állvány**

A szerelősínre, vagy „kalapsínre” pattintható jelölő, ami alkalmas a sín, vagy sínszakasz jelölésére a 13/7 (SJ15/SJ9) mm-es papír feliratozás utáni, az arra kialakított horonyba helyezésével.

**KJ-A kapocssor-jelölő**

REC3 rögzítőelemre pattintva a kapocssorok jelölésére alkalmas úgy, hogy a 44 x 7 mm-es jelölő lapkát a megfelelően kialakított horonyba helyezzük.

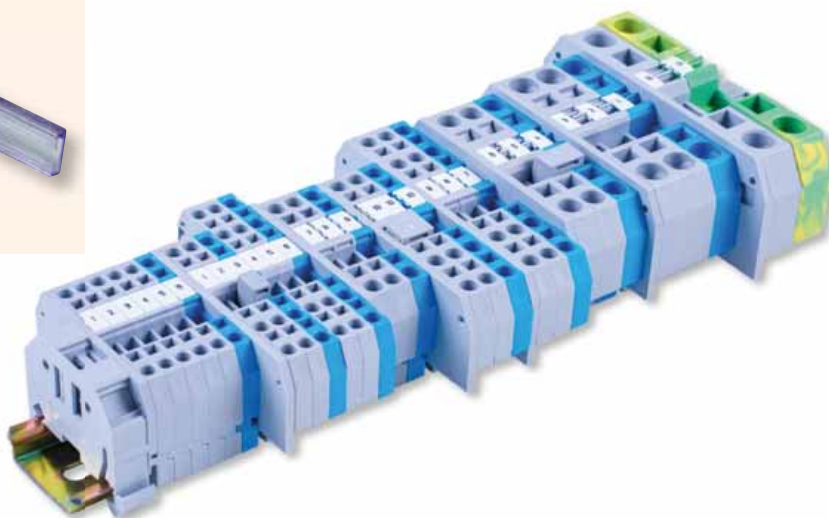
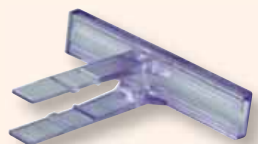

TEST DOCUMENTATION
TLZJ17031110317

TEST DOCUMENTATION
TLZJ17031110318

RELEVANT STANDARD
EN 60947-7-1

RELEVANT STANDARD
EN 60947-7-2

TRACON		X	U _n	I _n	mm ²	W (mm)	L (mm)	H (mm)	
TSKC2,5	Általános	× 2	800 V	24 A	0.2-4	0.2-2.5	5	53.5	32.5
TSKC2,5/3	Általános	× 3	800 V	24 A	0.2-4	0.2-2.5	5	65	32.5
TSKC2,5/4	Általános	× 4	800 V	20 A	0.2-4	0.2-2.5	5	76.5	33
TSKC4	Általános	× 2	800 V	32 A	0.2-6	0.2-4	6	60	33.5
TSKC4/3	Általános	× 3	800 V	32 A	0.2-6	0.2-4	6	74.5	33
TSKC4/4	Általános	× 4	800 V	26 A	0.2-6	0.2-4	6	86.5	33
TSKC6	Általános	× 2	800 V	41 A	0.2-10	0.2-6	8.2	73.8	40
TSKC10	Általános	× 2	800 V	57 A	0.2-16	0.2-10	10	77.4	42
TSKC16	Általános	× 2	800 V	76 A	0.2-16	0.2-10	12	94	44.8
TSKC2,5JD	Védővezető	× 2	-	24 A	0.2-4	0.2-2.5	5	53.5	32.5
TSKC2,5/3JD	Védővezető	× 3	-	24 A	0.2-4	0.2-2.5	5	65	32.5
TSKC2,5/4JD	Védővezető	× 4	-	20 A	0.2-4	0.2-2.5	5	76.5	33
TSKC4JD	Védővezető	× 2	-	32 A	0.2-6	0.2-4	6	60	33.5
TSKC4/3JD	Védővezető	× 3	-	32 A	0.2-6	0.2-4	6	74.5	33
TSKC4/4JD	Védővezető	× 4	-	26 A	0.2-6	0.2-4	6	86.5	33
TSKC6JD	Védővezető	× 2	-	41 A	0.2-10	0.2-6	8.2	73.8	40
TSKC10JD	Védővezető	× 2	-	57 A	0.2-16	0.2-10	10	77.4	42
TSKC16JD	Védővezető	× 2	-	76 A	0.2-16	0.2-10	12	94	44.8
TSKC2,5-K	Nullavezető	× 2	800 V	24 A	0.2-4	0.2-2.5	5	53.5	32.5
TSKC2,5/3-K	Nullavezető	× 3	800 V	24 A	0.2-4	0.2-2.5	5	65	32.5
TSKC2,5/4-K	Nullavezető	× 4	800 V	20 A	0.2-4	0.2-2.5	5	76.5	33
TSKC4-K	Nullavezető	× 2	800 V	32 A	0.2-6	0.2-4	6	60	33.5
TSKC4/3-K	Nullavezető	× 3	800 V	32 A	0.2-6	0.2-4	6	74.5	33
TSKC4/4-K	Nullavezető	× 4	800 V	26 A	0.2-6	0.2-4	6	86.5	33
TSKC6-K	Nullavezető	× 2	800 V	41 A	0.2-10	0.2-6	8.2	73.8	40
TSKC10-K	Nullavezető	× 2	800 V	57 A	0.2-16	0.2-10	10	77.4	42
TSKC16-K	Nullavezető	× 2	800 V	76 A	0.2-16	0.2-10	12	94	44.8
TSKC2,5/3D	Általános	× 3	800 V	24 A	0.2-4	0.2-2.5	5	50.5	41
TSKC2,5/4D	Általános	× 4	800 V	24 A	0.2-4	0.2-2.5	5	50.5	41
TSKC4/3D	Általános	× 3	800 V	32 A	0.2-6	0.2-4	6	62	41
TSKC2,5/3JDD	Védővezető	× 3	-	24 A	0.2-4	0.2-2.5	5	50.5	41
TSKC4/3JDD	Védővezető	× 3	-	32 A	0.2-6	0.2-4	6	62	41
TSKC2,5/3D-K	Nullavezető	× 3	800 V	24 A	0.2-4	0.2-2.5	5	50.5	41
TSKC2,5/4D-K	Nullavezető	× 4	800 V	24 A	0.2-4	0.2-2.5	5	50.5	41
TSKC4/3D-K	Nullavezető	× 3	800 V	32 A	0.2-6	0.2-4	6	62	41
TSKC2,5E	Emeletes	2 × 2	500 V	20 A	0.2-4	0.2-2.5	5	75	44
TSKC4E	Emeletes	2 × 2	500 V	26 A	0.2-6	0.2-4	6	83	43
TSKC2,5EE	Emeletes	3 × 2	500 V	20 A	0.2-4	0.2-2.5	5	104	55
TSKC4B	Biztosítós	× 2	250 V	6.3 A	0.2-6	0.2-4	6	60	83
TSKC6B	Biztosítós	× 2	220 V	10 A	0.2-10	0.2-6	12.8	62.3	60
TSKC6S	Mérő	× 2	400 V	41 A	0.2-10	0.2-6	8	86	42

Piktogramok **A/O**

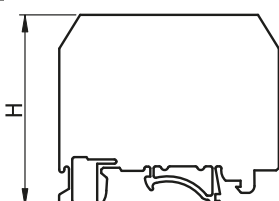
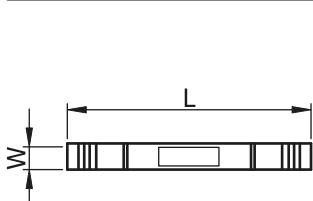

Általános,
nullavezető

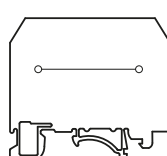

Emeletes

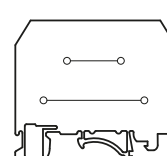

Háromkapcsos

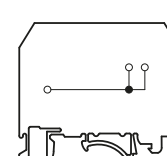



TRACON

8	VLC2,5	SFC2,5	AHC2,5	TSKCJS	REC1, REC2, REC3	TSKC2,5
9	VLC2,5/3	SFC2,5	AHC2,5	TSKCJS	REC1, REC2, REC3	TSKC2,5/3
9	VLC2,5/4	SFC2,5	AHC2,5	TSKCJS	REC1, REC2, REC3	TSKC2,5/4
10	VLC4	SFC4	AHC4	TSKCJS	REC1, REC2, REC3	TSKC4
10	VLC4/3	SFC4	AHC4	TSKCJS	REC1, REC2, REC3	TSKC4/3
10	VLC4/4	SFC4	AHC4	TSKCJS	REC1, REC2, REC3	TSKC4/4
10	VLC6	SFC6	AHC6	TSKCJS	REC1, REC2, REC3	TSKC6
12	VLC10	SFC10	AHC10	TSKCJS	REC1, REC2, REC3	TSKC10
14	VLC16	SFC16	AHC16	TSKCJS	REC1, REC2, REC3	TSKC16
8	-	-	-	TSKCJS	REC1, REC2, REC3	TSKC2,5JD
9	-	-	-	TSKCJS	REC1, REC2, REC3	TSKC2,5/3JD
9	-	-	-	TSKCJS	REC1, REC2, REC3	TSKC2,5/4JD
10	-	-	-	TSKCJS	REC1, REC2, REC3	TSKC4JD
9	-	-	-	TSKCJS	REC1, REC2, REC3	TSKC4/3JD
10	-	-	-	TSKCJS	REC1, REC2, REC3	TSKC4/4JD
10	-	-	-	TSKCJS	REC1, REC2, REC3	TSKC6JD
12	-	-	-	TSKCJS	REC1, REC2, REC3	TSKC10JD
14	-	-	-	TSKCJS	REC1, REC2, REC3	TSKC16JD
8	VLC2,5	SFC2,5	AHC2,5	TSKCJS	REC1, REC2, REC3	TSKC2,5-K
9	VLC2,5/3	SFC2,5	AHC2,5	TSKCJS	REC1, REC2, REC3	TSKC2,5/3-K
9	VLC2,5/4	SFC2,5	AHC2,5	TSKCJS	REC1, REC2, REC3	TSKC2,5/4-K
10	VLC4	SFC4	AHC4	TSKCJS	REC1, REC2, REC3	TSKC4-K
9	VLC4/3	SFC4	AHC4	TSKCJS	REC1, REC2, REC3	TSKC4/3-K
10	VLC4/4	SFC4	AHC4	TSKCJS	REC1, REC2, REC3	TSKC4/4-K
10	VLC6	SFC6	AHC6	TSKCJS	REC1, REC2, REC3	TSKC6-K
12	VLC10	SFC10	AHC10	TSKCJS	REC1, REC2, REC3	TSKC10-K
14	VLC16	SFC16	AHC16	TSKCJS	REC1, REC2, REC3	TSKC16-K
9	VLC2,5/3D	SFC2,5	AHC2,5	TSKCJS	REC1, REC2, REC3	TSKC2,5/3D
9	VLC2,5/3D	-	-	TSKCJS	REC1, REC2, REC3	TSKC2,5/4D
9	VLC4/3D	SFC4	AHC4	TSKCJS	REC1, REC2, REC3	TSKC4/3D
9	VLC2,5/3D	-	-	TSKCJS	REC1, REC2, REC3	TSKC2,5/3JDD
9	VLC4/3D	-	-	TSKCJS	REC1, REC2, REC3	TSKC4/3JDD
9	VLC2,5/3D	SFC2,5	AHC2,5	TSKCJS	REC1, REC2, REC3	TSKC2,5/3D-K
9	VLC2,5/3D	-	-	TSKCJS	REC1, REC2, REC3	TSKC2,5/4D-K
9	VLC4/3D	SFC4	AHC4	TSKCJS	REC1, REC2, REC3	TSKC4/3D-K
9	VLC2,5E	SFC2,5	AHC2,5	TSKCJS+TSKC-EJ	REC1, REC2, REC3	TSKC2,5E
10	VLC4E	SFC4	AHC4	TSKCJS+TSKC-EJ	REC1, REC2, REC3	TSKC4E
9	VLC2,5EE	SFC2,5	AHC2,5	TSKCJS+TSKC-EJ	REC1, REC2, REC3	TSKC2,5EE
10	VLC4	-	-	-	REC1, REC2, REC3	TSKC4B
9	VLC6B	SFC6	AHC6	TSKCJS	REC1, REC2, REC3	TSKC6B
11	VLC6S	SFC6	AHC6	TSKCJS	REC1, REC2, REC3	TSKC6S



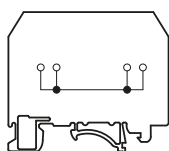

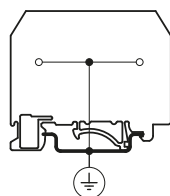
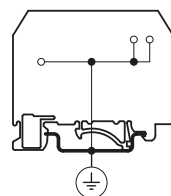
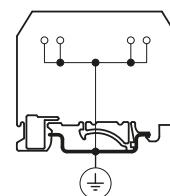

Négykapcsos



Védővezető

Védővezető,
háromkapcsosVédővezető,
négykapcsos

Táblázat fejlecek piktogramjai

 Tömeg	 Környezeti hőmérséklet	 Csavarhúzó fejek típusai	 Szerszám hosszúsága
 Max. vágási keresztmetszet	 Max. vágási átmérő	 Préselési tartomány	 Beköthető vezeték keresztmetszet
 Dugattyú lökethossz	 Lyukasztási kapacitás	 Max. préselési erő	 A fej 360°-ban forgatható
 Akkumulátor teljesítménye (Ah)	 Akkumulátor feszültsége (V)	 Akkumulátor típusa	 Feszítőerő beállítható
 Vágási szélesség	 Megjegyzés, kiegészítés	 Névleges feszültség (V)	 Névleges teljesítmény

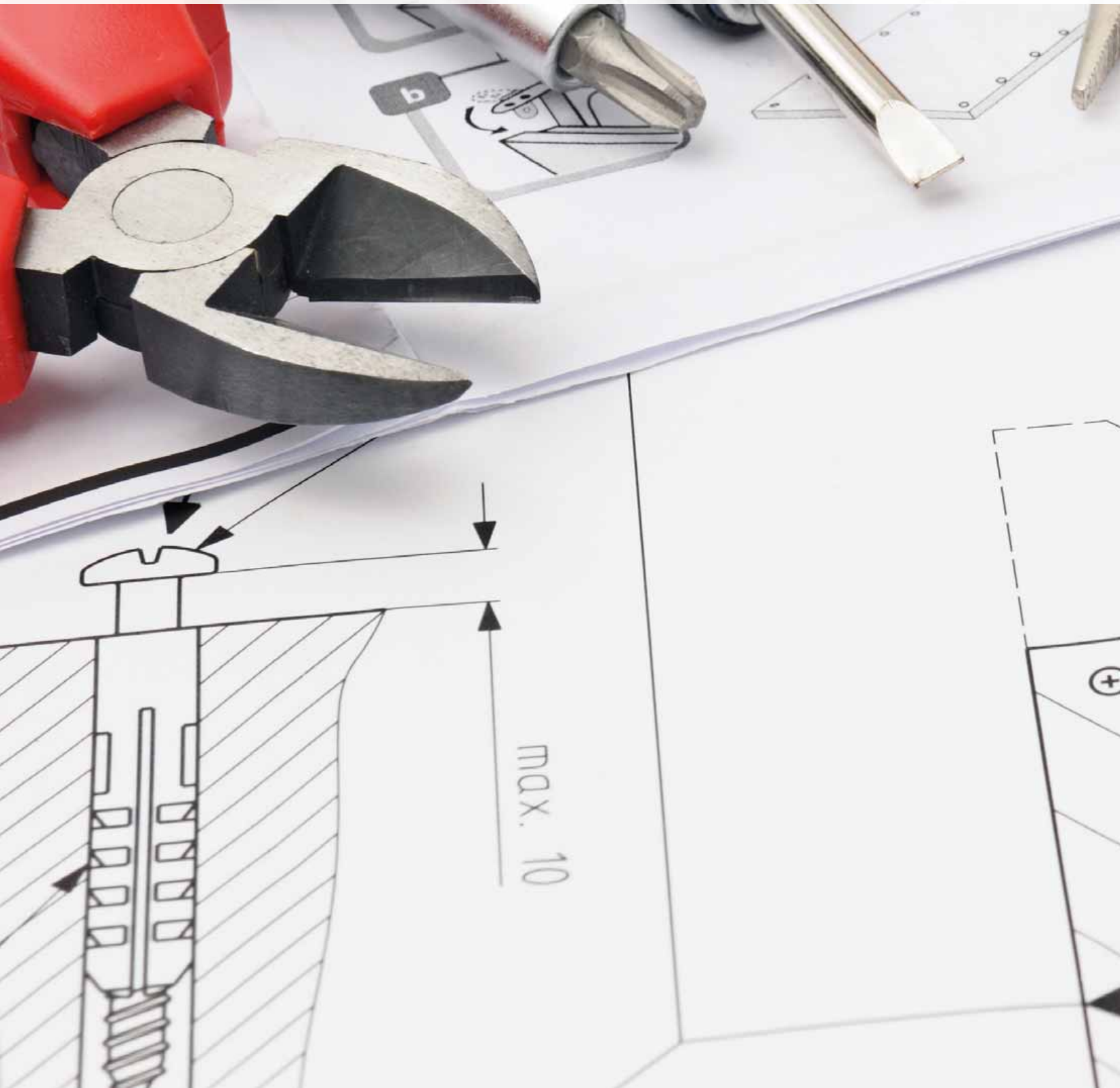



Ervéghüvelyprések **2**



Csupaszító és vágószerszámok **3**



Univerzális csupaszító és vágó szerszám **4**



Vágó, csupaszító és préserszám kommunikációs technikához **4**



Univerzális ervéghüvelyprés szigetetlen, szigetelt, egyes- és ikerervéghüvelyekhez **5**



Univerzális préserszám szigetelt kábel-sarukhoz és rátolható csatlakozókhoz **6**



Univerzális préserszám szigetetlen kábel-sarukhoz **6**



Mechanikus préserszám szigetetlen kábel-sarukhoz **7**



Univerzális préserszám szigetetlen rátolható csatlakozókhoz **7**



Kézi működtetésű hidraulikus préserszám **8**



Akkumulátoros hidraulikus préserszám **9**



Akkumulátor töltő **9**



Akkumulátor **9**



Elektro-hidraulikus préserszám bélyegekkel, hordtáskában **10**



Elektro-hidraulikus kábelvágó szerszám, hordtáskában **11**



Hidraulikus húzóprás és lyukasztó **12**



Áttételes kábelvágó réz és alumínium kábelekhöz **13**



Kábelvágó szerszám réz és alumínium kábelekhöz **14**



1000 V-ra szigetelt fogók **14**

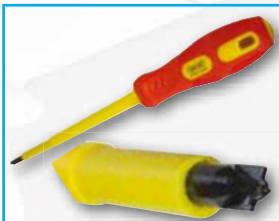

1000 V-ra szigetelt csavarhúzó, kombiprofil **15**

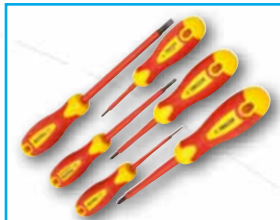

1000 V-ra szigetelt csavarhúzó szett **15**



SD - CrV hegyű csavarhúzók **16**



SD - CrV hegyű csavarhúzók **17**



Kötegfeszítő és vágó kéziszerszám **18**



Feszítő- és vágószerszám acél kábelköteglőhöz **18**



Behúzószálak **18**



Hőlégfúvó **19**



Kétélű csupaszítókés **19**



Kábelcsupaszító szerszám **19**









UTILK pengés kések **20**

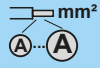



BD pengék **21**

Érvéghüvelyprések

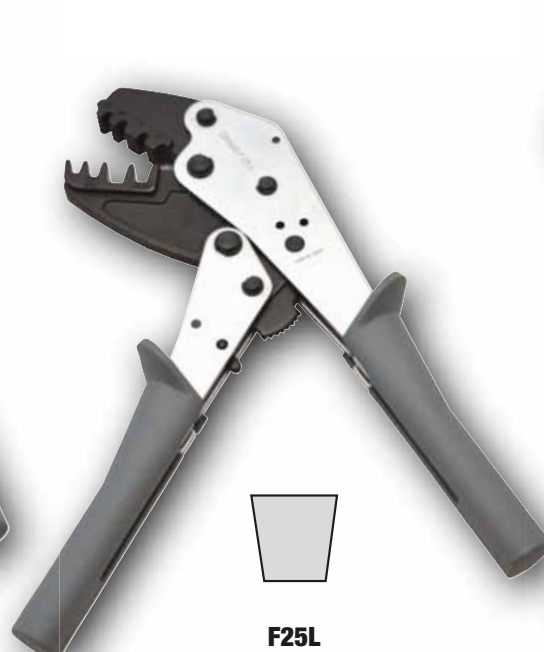
TRACON		 mm ²		
F6L		0,5-6	205 mm	470 g
F25L		6-25	240 mm	620 g
F50L		35-50	240 mm	620 g



Csupaszító és vágószerszámok

TRACON	 mm ²		 m
MACS6	0,08-6	205 mm	180 g
MACS16	6-16	205 mm	180 g



Présszerszám készlet SOLAR11-4AB és SOLAR11-4N csatlakozóhoz

TRACON	 mm ²		 m
SOLAR11-PT	2.5-6	270 mm	725 g / 1710 g





OLVASSA BE A KÓDOT!

- Nézze meg újdonságainkat
- Legyen naprakész

Kínálatunk gyorsan és folyamatosan fejlődik!
Katalógusunk a 2021. áprilisi állapotot tükrözi.

**Naprakész információért
látogasson el honlapunkra!**

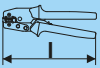
Univerzális csupaszító és vágó szerszám

TRACON	 mm ²		 m
TKCS	0,1-4 (6)	200 mm	175 g
TP700A	0,25-2,5	180 mm	380 g
TP700B	0,75-6	180 mm	380 g
LY731	0,5-6	200 mm	300 g



TKCS



TP700A







TP700B



LY731

Vágó, csupaszító és prészszerző kommunikációs technikához

TRACON		 m	
RJ86	220 mm	310 g	RJ11, RJ12, RJ45
RJ468	220 mm	200 g	RJ11, RJ12, RJ45, RJ50
RG317 	230 mm	200 g	BNC, TNC, RG 1,72 / 2,6 / 5,4 / 6,5 / 8,1 mm



RJ86



RJ468



RG317

















OLVASSA BE A KÓDOT!

- Nézze meg újdonságainkat
- Legyen naprakész

Kínálatunk gyorsan és folyamatosan fejlődik!
Katalógusunk a 2021. áprilisi állapotot tükrözi.

Naprakész információért
látogasson el honlapunkra!







Univerzális érvéghüvelyprés szigeteteletlen, szigetelt, egyes- és ikerérvéghüvelyekhez

TRACON		 mm ²		
9039		6-16	230 mm	600 g
9102-LT		0,25-2,5	145 mm	160 g
9004-LT		0,5-16	180 mm	320 g
9039A-SPEC		0,25-6	175 mm	400 g
9039B-SPEC		6-16	210 mm	470 g
9039-HEXA		0,25-6	175 mm	400 g
9039A		1,5-6	230 mm	600 g
9039AR		0,5-6	230 mm	600 g
9039BR		10-35	230 mm	600 g
9039B		10-35	230 mm	600 g

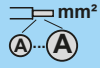
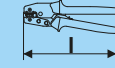
 **Piktogramok B/O**







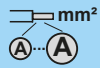
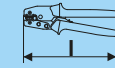

Univerzális prészszerző szigetelt kábelcsatlakozásokhoz

TRACON		 mm ²		 m
LY35C		10-35	490 mm	2.150 g
9006RS		0,5-2,5	230 mm	600 g
9006R		2,5-6	230 mm	600 g
9006		2,5-6	230 mm	600 g











Univerzális prészszerző szigetetlen kábelcsatlakozásokhoz

TRACON		 mm ²		 m
HD156R		1,5-6	225 mm	540 g
HD156		1,5-6	247 mm	540 g
KH8		1,5-10	280 mm	470 g
KH14		6-16	280 mm	470 g
KH16		1,5-16	280 mm	470 g



Mechanikus prészerszám szigetetlen kábelsarukhoz

TRACON					mm ²		m
KH120					10-95	645 mm	3.000 g
HX50B*					6-50	390 mm	1.300 g
HX120B*					10-120	630 mm	4.000 g
HX150B*					25-150	650 mm	3.200 g

* A préselési tartomány függ az alkalmazandó saru vagy toldóhüvely típusától és méreteitől, lásd A fejezet! A présbéllyeg tartozék.



KH120

HX50B
HX120B
HX150B

HX50B-FEJ
Présbéllyeg HX50B szigetetlen
kábel-saru prészerszámhoz
Réz és alumínium sarukhoz







HX120B-FEJ
Présbéllyeg HX120B szigetetlen
kábel-saru prészerszámhoz
Réz és alumínium sarukhoz



HX150B-FEJ
Présbéllyeg HX150B szigetetlen
kábel-saru prészerszámhoz
Réz és alumínium sarukhoz

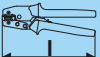

Univerzális prészerszám szigetetlen rátolható csatlakozókhoz

TRACON			mm ²		m
LY03BR			0,5-6	230 mm	600 g
LY03B			0,5-6	230 mm	600 g

 Piktogramok **B/O**

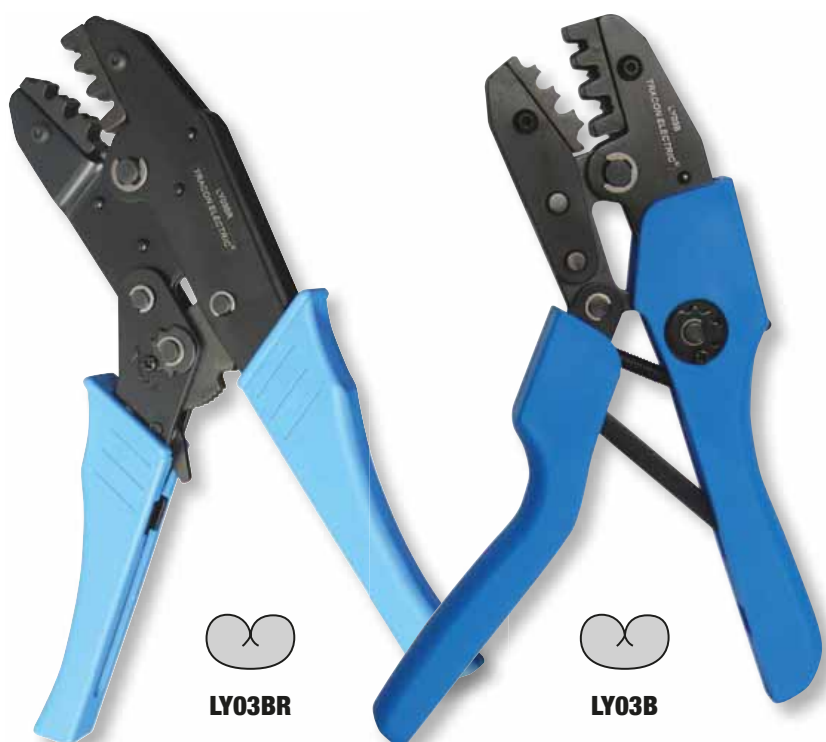









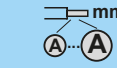

LY03BR



LY03B

Kézi működtetésű hidraulikus prészszerző



TRACON		 mm ²	 kN max			 m
D31*		4-95	35	360°	200 mm	1.550 g
D51*		10-185	55	180°	365 mm	2.500 g
D52F*		10-240	67	180°	375 mm	2.800 g
C120F*		16-400	120	180°	590 mm	7.000 g
KHP70**		4-70	50	-	375 mm	3.000 g
KHP240**		16-240	120	-	480 mm	6.250 g

*Tartozék: műanyag hordtáska

**Tartozék: műanyag hordtáska + présbéllyegek





Présbéllyegek D31 prészszerzőkhöz

TRACON		Cu  mm ²	Al  mm ²
D31-4	KZ 4	4	-
D31-6	KZ 5	6	4
D31-10	KZ 6	10	6
D31-16	KZ 8	16	10
D31-25	KZ 10	25	16
D31-35	KZ 12	35	25
D31-50	KZ 14	50	35
D31-70	KZ 16	70	50
D31-95	KZ 18	95	70





Présbéllyegek D52F prészszerzőkhöz

TRACON	Cu  mm ²	Al  mm ²
D52F-1016	10-16	10
D52F-2535	25-35	16-25
D52F-5070	50-70	50-35
D52F-95120	95-120	70-95
D52F-150	150	120
D52F-185	185	150
D52F-240	240	185





Présbéllyegek D51 prészszerzőkhöz

TRACON		Cu  mm ²	Al  mm ²
D51-10-120	KZ 6	10	6
	KZ 20	120	95
D51-16-70	KZ 8	16	10
	KZ 16	70	50
D51-25-95	KZ 10	25	16
	KZ 18	95	70
D51-35-50	KZ 12	35	25
	KZ 14	50	35
D51-150	KZ 22	150	120
D51-185	KZ 25	185	150











Présbéllyegek C120F prészszerzőkhöz

TRACON	Cu  mm ²	Al  mm ²
C120F-16	16	-
C120F-25	25	16
C120F-35	35	25
C120F-50	50	35
C120F-70	70	50
C120F-95	95	70
C120F-120	120	95
C120F-150	150	120
C120F-185	185	150
C120F-240	240	185
C120F-300	300	240
C120F-400	400	300



Akkumulátoros hidraulikus prészszerző

TRACON		 mm ²	 kN max			 m
D31E		4-95	35	360°	200 mm	1.550 g
D55E		10-185	55	340°	315 mm	3.250 g
D62E		6-240	62	340°	320 mm	3.550 g

Tartozék:

- Akkumulátor töltő, AKKUT1
- Akkumulátor, AKKU1
- Fém hordtáska



Présbéllyegek D62E prészszerzőhöz

TRACON		Cu mm ²	Al mm ²
D62-10	KZ 6	10	6
D62-16	KZ 8	16	10
D62-25	KZ 10	25	16
D62-35	KZ 12	35	25
D62-50	KZ 14	50	35
D62-70	KZ 16	70	50
D62-95	KZ 18	95	70
D62-120	KZ 20	120	95
D62-150	KZ 22	150	120
D62-185	KZ 25	185	150
D62-240	KZ 28	240	185
D62-300	KZ 32	300	240



D62E

Présbéllyegek D31E prészszerzőkhöz

TRACON		Cu mm ²	Al mm ²
D31-4	KZ 4	4	-
D31-6	KZ 5	6	4
D31-10	KZ 6	10	6
D31-16	KZ 8	16	10
D31-25	KZ 10	25	16
D31-35	KZ 12	35	25
D31-50	KZ 14	50	35
D31-70	KZ 16	70	50
D31-95	KZ 18	95	70







Présbéllyegek D55E prészszerzőkhöz

TRACON		Cu mm ²	Al mm ²
D51-10-120	KZ 6	10	6
	KZ 20	120	95
D51-16-70	KZ 8	16	10
	KZ 16	70	50
D51-25-95	KZ 10	25	16
	KZ 18	95	70
D51-35-50	KZ 12	35	25
	KZ 14	50	35
D51-150	KZ 22	150	120
D51-185	KZ 25	185	150





Akkumulátor töltő

TRACON		 V	 Ah	
AKKUT1	230 V AC	18 V	2100 mAh	Li-ion











Akkumulátor

TRACON	 V	 Ah	
AKKU1	18 V	2000 mAh	Li-ion



Elektro-hidraulikus prészerszám bélyegekkel, hordtáskában









TRACON	 mm ²	 kN max	 350°	 420 mm	 V	 Ah	 Li-ion	 230 V AC	 m
DK60E	16-300	60	350°	420 mm	18 V	2×3200 mAh	Li-ion	230 V AC	4.900 g

Préselési erő:	60 KN
Lökethossz:	17 mm
Préselések száma egy töltéssel:	320 préselés (Cu 150mm ²)
Préselési idő:	3-6s (függ a kábel méretétől)
Akkumulátor feszültség:	18 V
Töltés:	3.2 Ah
Súly (akkumulátorral):	4.9 kg
Töltési idő:	1 óra
Hordtáska:	műanyag doboz

Tartozékok (szállítási terjedelemben):	
Présbélyegek:	16, 25, 35, 50, 70, 95, 120, 150, 185, 240, 300 mm ²
Akkumulátor:	2 db
Töltő:	1 db
Munkahenger tömítőgyűrű:	1 készlet
Biztonsági szelep tömítőgyűrű:	1 készlet



Elektro-hidraulikus kábelvágó szerszám, hordtáskában

TRACON	 d_{max}	 kN_{max}	 360°	 610 mm	 18 V	 2×5000 mAh	 Li-ion	 230 V AC	 8.550 g
DKV105	105 mm	120	360°	610 mm	18 V	2×5000 mAh	Li-ion	230 V AC	8.550 g

Vágóerő:	120 KN
Lökethossz:	108 mm
Vágási tartomány:	Ø 105 mm Cu/Al kábel és páncélozott kábel
Vágások száma egy töltéssel:	~70 vágás
Vágási idő:	15-30s (függ a kábel méretétől és anyagától)
Akkumulátor feszültség:	18 V
Töltés:	5.0 Ah
Töltési idő:	1 óra
Méret:	610 × 430 × 85mm
Hordtáska:	műanyag doboz

Tartozékok (szállítási terjedelemben):

Akkumulátor:	2 db
Töltő:	1 db
Munkahenger tömítőgyűrű:	1 készlet
Biztonsági szelep tömítőgyűrű:	1 készlet



Hidraulikus húzóprés és lyukasztó



TRACON	kN max	Imax	a	m
HKS-15	150 kN	max. 2-3 mm	25 mm	6.2 kg

A prés tartozékai: Ø21,8mm; Ø27,6mm; Ø34,1mm; Ø42,7mm; Ø48,7mm; Ø60,5mm;
□32×32mm présbéllyegek

Fém lemezszekrények szerelvényezéséhez használható. A szerszám segítségével könnyedén szerelvényezhetünk fel egy fém lemezszekrényt jelzőlámpákkal, nyomógombokkal, kézi kapcsolókkal, valamint a kábelek fémszekrénybe való bevezetésére szolgáló tömítőszelencékkel is. Hordtáskával szállítjuk.



Rendelhető tartozékok



TRACON		Imax
HKS-15-20	MG20 tömítőszelence	Ø20 mm
HKS-15-22	Ø22 mm-es nyomógomb	Ø22 mm
HKS-15-25	MG25 tömítőszelence	Ø25 mm
HKS-15-32	MG32 tömítőszelence	Ø32 mm
HKS-15-40	MG40 tömítőszelence	Ø40 mm
HKS-15-50	MG50 tömítőszelence	Ø50 mm
HKS-15-63	MG63 tömítőszelence	Ø63 mm
HKS-15-PG13,5	PG13,5 tömítőszelence	Ø20 mm
HKS-15-PG16	PG16 tömítőszelence	Ø23,5 mm
HKS-15-PG21	PG21 tömítőszelence	Ø29,5 mm
HKS-15-PG29	PG29 tömítőszelence	Ø38 mm
HKS-15-PG36	PG36 tömítőszelence	Ø46 mm
HKS-15-PG42	PG42 tömítőszelence	Ø51 mm
HKS-15-PG48	PG48 tömítőszelence	Ø59 mm
HKS-15-43X43	48×48 mm keretméretű műszer	□43×43 mm
HKS-15-68X68	72×72 mm keretméretű műszer	□68×68 mm
HKS-15-92X92	96×96 mm keretméretű műszer	□92×92 mm
HKS-15-BSZ10	Behúzószár, 105 mm	max. 2-3 mm

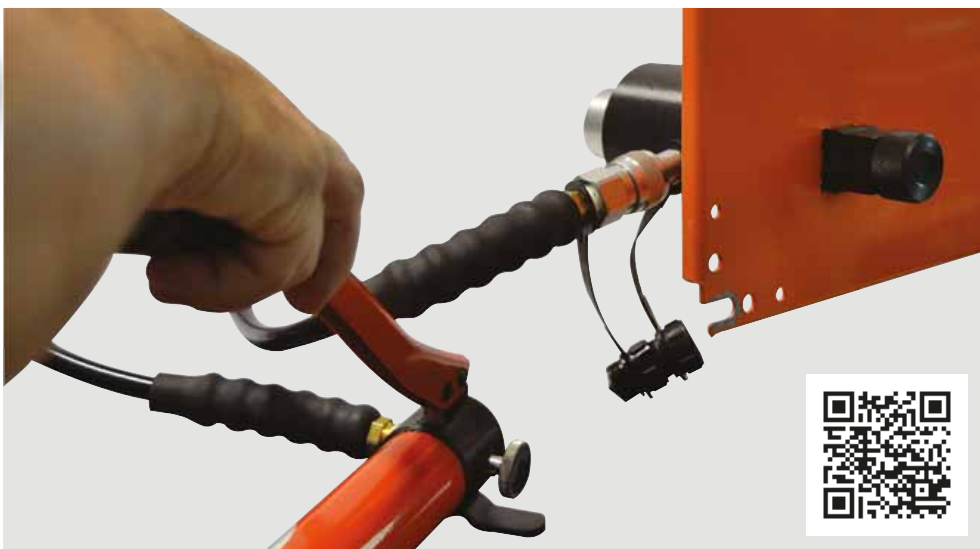

Áttételes kábelvágó réz és alumínium kábelekhez

TRACON	d_{max} 	NYN 	NYN 	NYCWY 	NAYY 	NAYY 	AYCWY
RKV300	35 mm	max. 4×50	max. 1×240	max. 4×50/25	max. 4×70	max. 1×300	max. 4×50/25
RKV700	60 mm	max. 4×95	max. 1×240	max. 4×95/50	max. 4×120	max. 1×300	max. 4×95/35
RKV1000	95 mm	–	–	max. 4×240/120	max. 4×240	max. 1×500	–





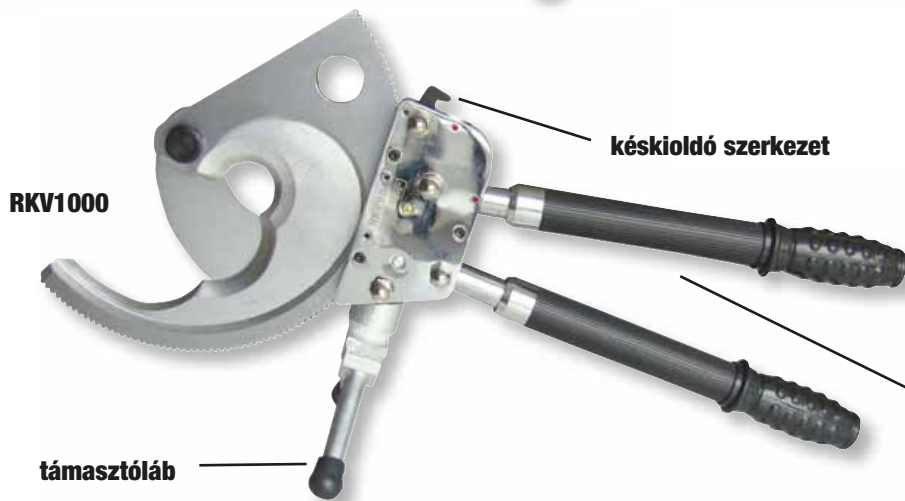

teleszkópos nyél



teleszkópos nyél





Kábelvágó szerszám réz és alumínium kábelekhez

TRACON	A_{max} 	d_{max} 		
CC22	16 mm ²	5,5 mm	150 mm	190 g
CC38	25 mm ²	6,5 mm	210 mm	350 g
CC60	35 mm ²	8 mm	230 mm	510 g
CC80	70 mm ²	9 mm	235 mm	510 g
CC100	100 mm ²	15 mm	320 mm	500 g
CC250	250 mm ²	17 mm	600 mm	1250 g
CC500	500 mm ²	25 mm	800 mm	2850 g

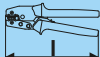

1000 V-ra szigetelt fogók



TRACON			
KF-1000	160 mm	230 g	kombinált fogó
KF-1000-2	200 mm	370 g	kombinált fogó
KB-1000	160 mm	230 g	csupaszoló fogó
KC-1000	160 mm	210 g	csípőfogó
KL-1000	160 mm	230 g	laposfogó

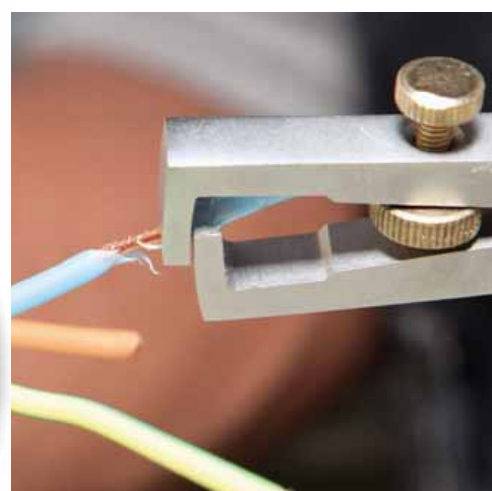

RELEVANT STANDARD
EN 60900



SD típusú 1000 V-ra szigetelt csavarhúzó



TRACON		
SD375F		3×75 mm
SD4100F		4×100 mm
SD5125F		5×125 mm
SD6100F		6×100 mm
SD6125F		6×125 mm
SD6150F		6×150 mm
SD375S		3×75 mm (PH0)
SD4100S		4×100 mm
SD5125S		5×125 mm (PH1)
SD6100S		6×100 mm (PH2)
SD6125S		6×125 mm (PH2)
SD6150S		6×150 mm (PH2)



RELEVANT STANDARD
EN 60900



1000 V-ra szigetelt csavarhúzó, kombiprofil

TRACON		
SDDK4100S		4×100 mm
SDDK5125S		5×125 mm (PZ1)
SDDK6150S		6×150 mm (PZ2)

Az SDDK csavarhúzók speciális fejkialakításúak, melyek alkalmasak a Tracon kínálatában lévő fogyasztásmérőkben, kismegszakítókban, mágneskapcsolókban alkalmazott csavarok meghúzására.

Az SDDK csavarhúzók egyesítik a keresztornyú és a laposfejű csavarhúzók előnyeit, ezzel segítve a könnyebb és biztosabb meghúzást.





VDE TEST REPORT NO.:
40011797



RELEVANT STANDARD
EN 60900



1000 V-ra szigetelt csavarhúzó szett

TRACON		
KSET1000	1.0 × 5.5 × 125 mm	PH2 × 100 mm
	0.8 × 4.0 × 100 mm	PH1 × 80 mm
	0.4 × 2.5 × 75 mm	PH0 × 60 mm



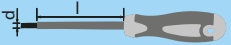

SD - CrV hegyű csavarhúzó

Egyenes fejű (SL) csavarhúzó

TRACON			
SD2575SL	SL 2,5 × 75 mm	CrV	52 g
SD40100SL	SL 4,0 × 100 mm	CrV	58 g
SD55125SL	SL 5,5 × 125 mm	CrV	90 g
SD65150SL	SL 6,5 × 150 mm	CrV	127 g



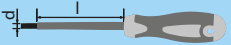

Kereszthornú (Phillips, PH) csavarhúzó

TRACON			
SD3060PH0	PH0 3,0 × 60 mm	CrV	49 g
SD5080PH1	PH1 5,0 × 80 mm	CrV	73 g
SD60100PH2	PH2 6,0 × 100 mm	CrV	102 g
SD80150PH3	PH3 8,0 × 150 mm	CrV	178 g



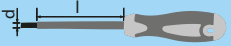

Pozidriv (PZ) csavarhúzó

TRACON			
SD3060PZ0	PZ0 3,0 × 60 mm	CrV	49 g
SD5080PZ1	PZ1 5,0 × 80 mm	CrV	73 g
SD60100PZ2	PZ2 6,0 × 100 mm	CrV	102 g
SD80150PZ3	PZ3 8,0 × 150 mm	CrV	178 g

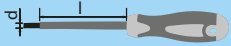

SD - CrV hegyű csavarhúzó

Kombifejű (SLPZ) csavarhúzó

TRACON			
SD5080SLPZ1	SL/PZ1 5,0 × 80 mm	CrV	73 g
SD60100SLPZ2	SL/PZ2 6,0 × 100 mm	CrV	102 g



CrV: →
króm-vanádium

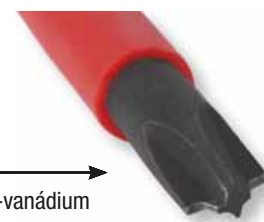



SD5080SLPZ1



SD60100SLPZ2



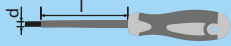

8 db-os csavarhúzó készlet tartóban

TRACON			
SDSET0F8			
-	SD2575SL	SL 2,5 × 75 mm	CrV 52 g
-	SD40100SL	SL 4,0 × 100 mm	CrV 58 g
-	SD55125SL	SL 5,5 × 125 mm	CrV 90 g
-	SD65150SL	SL 6,5 × 150 mm	CrV 127 g
-	SD3060PH0	PH0 3,0 × 60 mm	CrV 49 g
-	SD5080PH1	PH1 5,0 × 80 mm	CrV 73 g
-	SD60100PH2	PH2 6,0 × 100 mm	CrV 102 g
-	SD80150PH3	PH3 8,0 × 150 mm	CrV 178 g

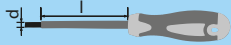

12 db-os csavarhúzó készlet tartóban

TRACON			
SDSET0F12			
-	SD2575SL	SL 2,5 × 75 mm	CrV 52 g
-	SD40100SL	SL 4,0 × 100 mm	CrV 58 g
-	SD55125SL	SL 5,5 × 125 mm	CrV 90 g
-	SD65150SL	SL 6,5 × 150 mm	CrV 127 g
-	SD3060PH0	PH0 3,0 × 60 mm	CrV 49 g
-	SD5080PH1	PH1 5,0 × 80 mm	CrV 73 g
-	SD60100PH2	PH2 6,0 × 100 mm	CrV 102 g
-	SD80150PH3	PH3 8,0 × 150 mm	CrV 178 g
-	SD3060PZ0	PZ0 3,0 × 60 mm	CrV 49 g
-	SD5080PZ1	PZ1 5,0 × 80 mm	CrV 73 g
-	SD60100PZ2	PZ2 6,0 × 100 mm	CrV 102 g
-	SD80150PZ3	PZ3 8,0 × 150 mm	CrV 178 g





OLVASSA BE A KÓDOT!

- Nézze meg újdonságainkat
- Legyen naprakész

Kínálatunk gyorsan és folyamatosan fejlődik!
Katalógusunk a 2021. áprilisi állapotot tükrözi.
Naprakész információért
látogasson el honlapunkra!

Kötegelőfeszítő és vágó kéziszerszám

TRACON		
TG007	2.2-8 mm	220 g
TG008	2.2-4.8 mm	320 g



TG008





TG007





Feszítő- és vágószerszám acél kábelkötegelőhöz

TRACON		
TGF	4,6 - 7,9mm	620 g







Behúzószálak

TRACON			
TBSZ-5	5 m		Műanyag behúzószál, fém fejjel és behúzóhurokkal
TBSZ-10	10 m	∅ = 3 mm	
TBSZ-20	20 m		
TBSZS-5	5 m		Fémspirál behúzószál
TBSZS-10	10 m	∅ = 3.2 mm	
TBSZS-20	20 m		
TBSZF-5	5 m		Lapos fémszalag behúzószál
TBSZF-10	10 m	d = 3.2 mm	
TBSZF-20	20 m		

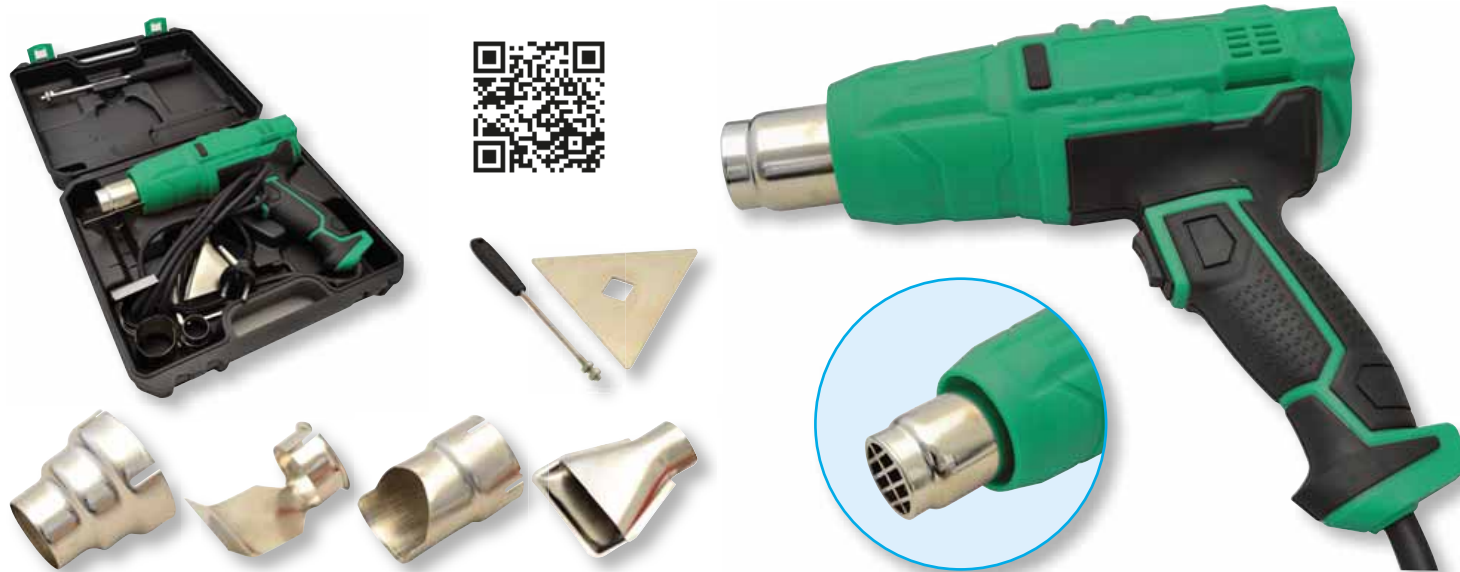

Hőlégfúvó

TRACON	U_n				
HLF-02	230 V AC	1.000/2.000 W	350/600 °C	1450 g	300 / 500 l/min



ZSUGORANYAGOK



Kétélű csupaszítókés

TRACON		
KB-UNI	160 mm	70 g



Kábelcsupaszító szerszám

TRACON		max. \varnothing	
KBY	200 mm	12 mm	95 g



OLVASSA BE A KÓDOT!

- Nézze meg újdonságainkat
- Legyen naprakész



Kínálatunk gyorsan és folyamatosan fejlődik!
Katalógusunk a 2021. áprilisi állapotot tükrözi.
Naprakész információért
látogasson el honlapunkra!

UTILK pengés kések

TRACON					
UTILK01			168×35×18 mm	l=110; d=18; x=0,7 (×4)	Zn + TPR
UTILK02			178×33×19 mm	l=110; d=18; x=0,7 (×1)	Zn + TPR
UTILK03			155×33×19 mm	l=110; d=18; x=0,7 (×1)	ABS + TPR
UTILK04			175×41×27 mm	l = 62; d=19; x=0,6 (×1)	Al + TPR
UTILK05			149×19×17 mm	l=90; d=12.5; x=0,2mm; x1	ABS
UTILK06			140×23×18 mm	l=90; d=12.5; x=0,2mm; x1	Al
UTILK07			145×22×18 mm	l=82; d=9; x=0,6mm; x1	TPR
UTILK08			145×21×17 mm	l=82; d=9; x=0,6mm; x1	ABS



BD pengék

TRACON		
BD02	l=90; d=12,5; x=0,2mm; (x30)	38 g
BD05	l=110; d=18; x=0,5mm; (x10)	105 g
BD06	l=110; d=18; x=0,6mm; (x10)	115 g
BD07	l=110; d=18; x=0,7mm; (x10)	125 g
BDT06	l=62; d=19; x=0,6mm; (x10)	92 g
BD069	l=82; d=9; x=0,6mm; (x10)	38 g

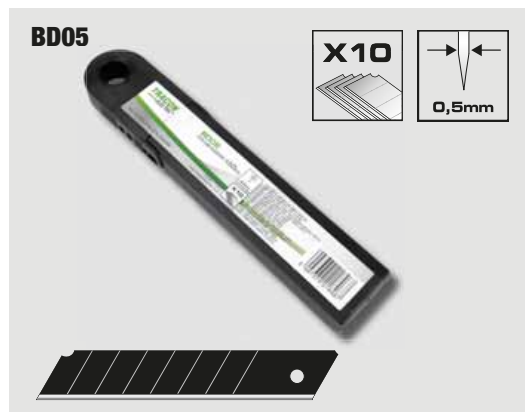

- Extrém éles • 5× tartósabb, mint a hagyományos penge • Rozsdamentes acél
- A lézervágásos élkiképzés több fokozattal nagyobb keménységet eredményez
 - Különösen kemény feladatokhoz • SK4 szerszámacél



OLVASSA BE A KÓDOT!

- Nézze meg újdonságainkat
- Legyen naprakész

Kínálatunk gyorsan és folyamatosan fejlődik!
Katalógusunk a 2021. áprilisi állapotot tükrözi.
Naprakész információért
látogasson el honlapunkra!

Táblázat fejlécek piktogramjai

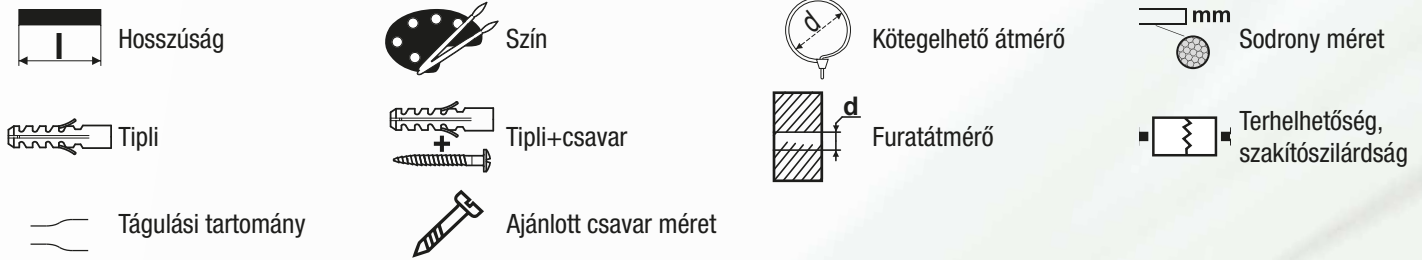

Műszaki adatok piktogramjai

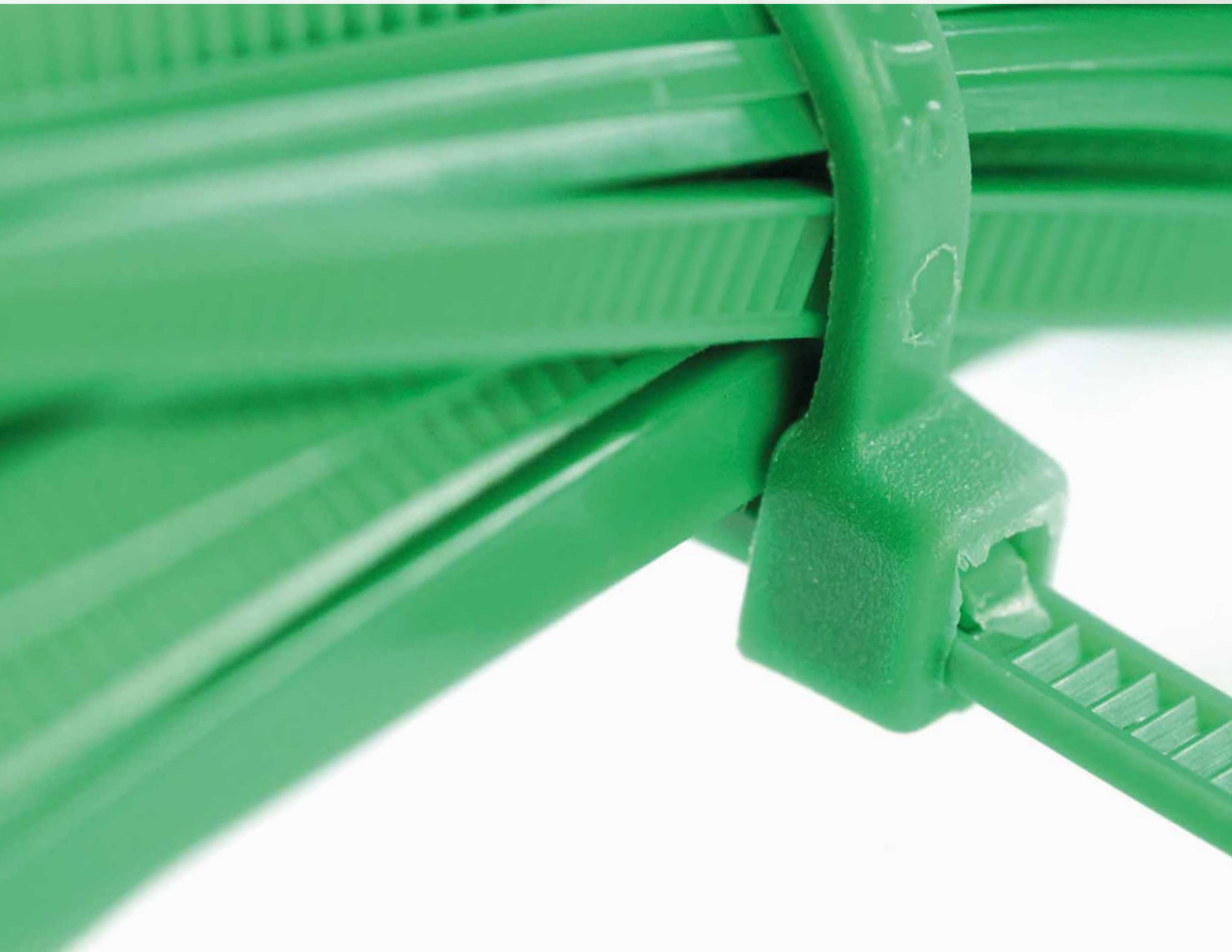
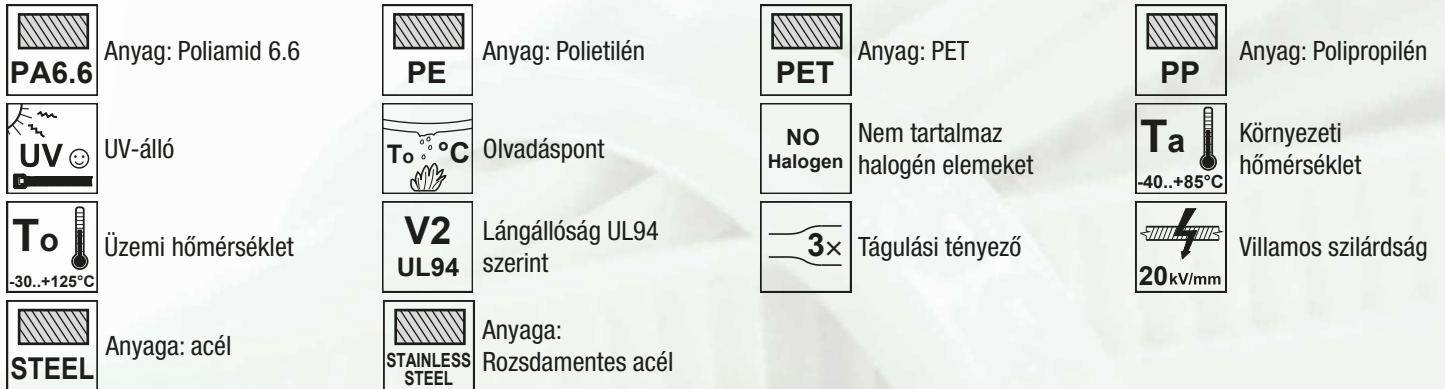



Hagyományos kábeltötegelők **2**



Színes kábeltötegelők **3**



UV-álló fényvelves kötegelők **4**



Nyitható kötegelők **5**



Gyöngyös nyitható kötegelők **5**



Hőálló kábeltötegelő **6**



Kábeltötegelő égésgátlóval **6**



Benyomótűskés kötegelő **6**



Jelzőcímkés kötegelők **7**



Acél kábeltötegelő **7**



Peremre csiptethető talp, kábeltötegelővel **8**



Tépőzárás kábelrendező **9**



Öntapadás kábeltartó **9**



Csavarozható kábeltötegelő talpak **10**



Normál beüthető kábeltötegelő tiplik **11**



Kábeltötegelő bilincs, szeggel **12**



Műanyag csőbilincs **12**



Kábeltötegelő tipli **13**



Peremes tipli, horog és kampó szerelvénnyel **14**



Peremes dübel, hatlapfejű peremes csavarral **14**



Beüthető gipszkarton tipli **14**



Nagy teherbírásiú nylon tipli minden anyagba **15**



Gipszkarton tiplik **15**



Beüthető tipli **16**



Peremes tipli **17**



Kötélszív **18**



Kampó **19**



U sodronyszorító bilincs **19**



Dupla sodronyszorító bilincs **20**



Rugós karabiner **21**



Kötélfeszítő **22**



Vezetékösszefogó spirál **23**



Önzáró fonott kábeltötegelő **23**



Jelölőplomba **24**



Mérőóra plomba **24**

C
Q

Hagyományos kábelkötegelők

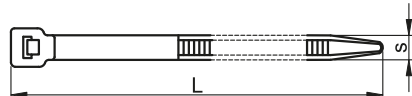

TRACON				
80PR		75 × 2.2 mm	0.75-15 mm	35 N
120PR		98 × 2.5 mm	1-21 mm	45 N
130PR		135 × 2.6 mm	1-32 mm	45 N
150PR		140 × 3.6 mm	2-36 mm	80 N
160PR		160 × 2.6 mm	1-40 mm	45 N
180PR		180 × 7.8 mm	3.5-45 mm	250 N
200PR		200 × 2.6 mm	1-52 mm	45 N
170PR		200 × 3.6 mm	2-50 mm	80 N
190PR		200 × 4.8 mm	3-50 mm	110 N
250PR		250 × 4.8 mm	3-68 mm	110 N
280PR		280 × 8.0 mm	4-65 mm	180 N
230PR		290 × 3.6 mm	2-80 mm	80 N
210PR		290 × 4.8 mm	3.5-79 mm	110 N
300PR		300 × 7.8 mm	5-80 mm	250 N
220PR		360 × 4.8 mm	3.5-103 mm	110 N
260PR		365 × 7.8 mm	8-100 mm	250 N
370PR		370 × 3.6 mm	5-108 mm	80 N
430PR		430 × 4.8 mm	3.5-115 mm	110 N
450PR		450 × 7.8 mm	35-130 mm	250 N
530PR		550 × 8 mm	10-160 mm	250 N
760PR		780 × 9 mm	35-233 mm	350 N
850PR		850 × 12.6 mm	40-255 mm	450 N
1000PR		1000 × 12.6 mm	40-302 mm	450 N
270PR		260 × 2.5 mm	3-73 mm	45 N
550PR		550 × 4.6 mm	4-160 mm	110 N
610PR		610 × 8.8 mm	9-181 mm	350 N
580PR		580 × 12.4 mm	9-168 mm	450 N



RELEVANT STANDARD
EN 62275



Tartósan ellenáll: szénhidrogén származékoknak, szerves oldószereknek, alkoholoknak
 Mérsékelten ellenáll: szerves savaknak, lúgoknak, szervesetlen sóknak, egyéb szerves anyagoknak
 Nem áll ellen: szervesetlen savaknak és oxidáló szereknek!



B/18

TG008

TG007



Színes kábelkötegelők

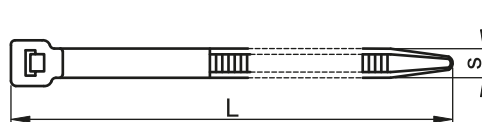
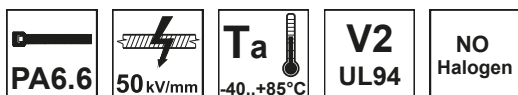

TRACON				
120K		98 × 2.5 mm	1-21 mm	45 N
150P		140 × 3.6 mm	2-36 mm	80 N
150Z		140 × 3.6 mm	2-36 mm	80 N
200K		200 × 2.6 mm	1-52 mm	45 N
170K		200 × 3.6 mm	2-50 mm	80 N
170P		200 × 3.6 mm	2-50 mm	80 N
190K		200 × 4.8 mm	3-50 mm	110 N
230NZ		290 × 3.6 mm	2-80 mm	80 N
170Z		203 × 3.6 mm	2 - 52 mm	80 N
190Z		203 × 4.6 mm	2 - 52 mm	110 N

RELEVANT STANDARD
EN 62275

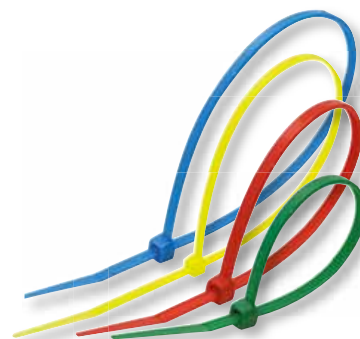

Fémnyelves kötegelők

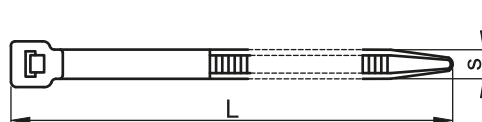
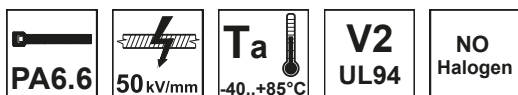

TRACON			
T92		92 × 2.4 mm	2-16 mm
T140		140 × 3.6 mm	2-29 mm
T186		186 × 4.8 mm	3.5-45 mm
T200		200 × 2.4 mm	2-50 mm
T208		208 × 3.6 mm	2-50 mm
T281		281 × 3.6 mm	2-76 mm
T293		293 × 4.8 mm	3.5-78 mm
T338		338 × 7.6 mm	3.5-120 mm
T360		360 × 4.8 mm	3.5-102 mm



UV-álló fémmvelves kötegelők

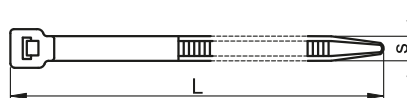
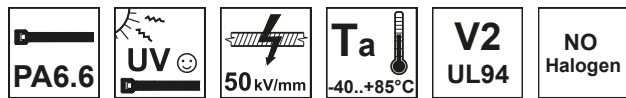

TRACON				
TU92		92 × 2.4 mm	2-16 mm	35 N
TU140		140 × 3.6 mm	2-29 mm	75 N
TU186		186 × 4.8 mm	3.5-45 mm	110 N
TU200		200 × 2.4 mm	2-50 mm	35 N
TU208		208 × 3.6 mm	2-50 mm	75 N
TU281		281 × 3.6 mm	2-76 mm	75 N
TU293		293 × 4.8 mm	3.5-78 mm	110 N
TU338		338 × 7.6 mm	3.5-120 mm	110 N
TU360		360 × 4.8 mm	3.5-102 mm	110 N



PA12 kötegelők

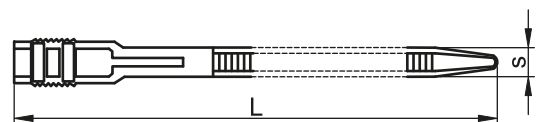
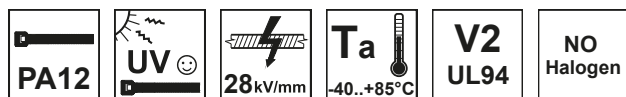

TRACON				
132-12		132 × 9.0 mm	4-27 mm	120 N
180-12		180 × 9.0 mm	5-45 mm	150 N
265-12		260 × 9.0 mm	25-65 mm	250 N
300-12		300 × 9.0 mm	25-80 mm	225 N
360-12		350 × 9.0 mm	25-93 mm	250 N



RELEVANT STANDARD
EN 62275



Nyitható kötegelők

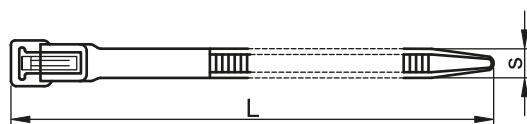
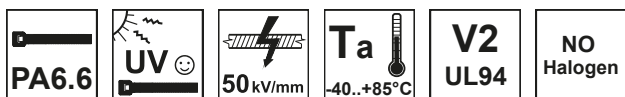

TRACON				
180-NY	181-NY	200 × 7.5 mm	10-50 mm	10-45 N
260-NY	261-NY	250 × 7.5 mm	10-65 mm	10-45 N
280-NY	281-NY	300 × 7.5 mm	10-70 mm	10-45 N
350-NY	351-NY	350 × 8 mm	10-120 mm	10-45 N



Gyöngyös nyitható kötegelők

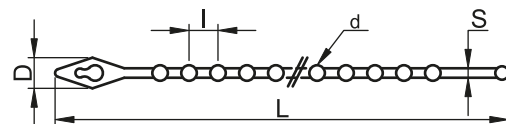
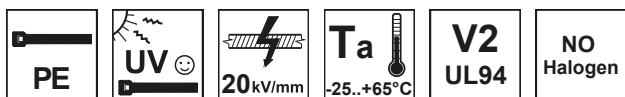

TRACON		L × S (mm)	d (mm)	D (mm)	I (mm)		
100N-GY	100F-GY	1.2 × 100	2.5	4.85	3	3 - 25 mm	45 N
120N-GY	120F-GY	120 × 1.3	2.5	5.5	3	6-25 mm	40 N
150N-GY	150F-GY	150 × 2	3	7.5	4.5	8-35 mm	40 N
160N-GY	160F-GY	1.7 × 150	2.6	7.73	4	4 - 38 mm	40 N
180N-GY	180F-GY	180 × 2	3	7.5	4.5	8-45 mm	40 N
200N-GY	200F-GY	1.8 × 200	2.5	7.63	5	5 - 59 mm	40 N



Hőálló kábelkötegelő

PA6.6
 50 kV/mm
 Ta -40..+105 °C
 V2 UL94
 NO Halogen

Piktogramok
 C/O

TRACON
 260T
 365 × 7.8 mm
 8-100 mm
 135 °C (5-8 min)
 250 N

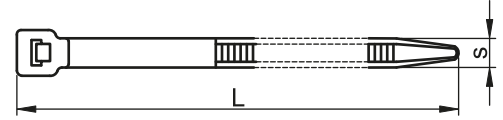
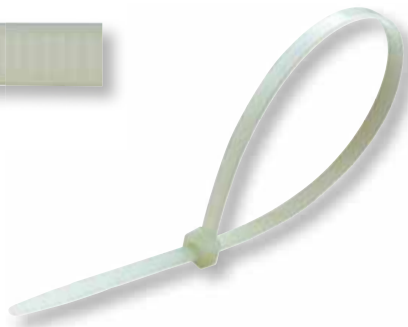

RELEVANT STANDARD
EN 62275

Kábelkötegelő égésgátlóval

PA6.6
 Ta -40..+85 °C
 V2 UL94
 NO Halogen

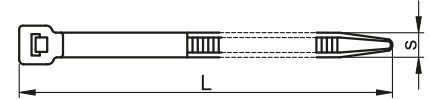

TRACON			
150L	3.6 × 150mm	4 - 36 mm	80 N
200L	4.6 × 200mm	4 - 52 mm	110 N
300L	4 × 300mm	4 - 81 mm	110 N
380L	7.6 × 380mm	9 - 108 mm	250 N

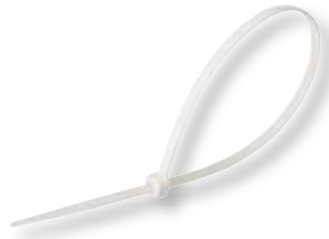

Benyomótüskés kötegelő

PA6.6
 50 kV/mm
 Ta -40..+85 °C
 V2 UL94
 NO Halogen

Piktogramok
 C/O

TRACON
 BK-130
 130 × 4.8 mm
 d=6 mm
 3-25 mm
 200 N

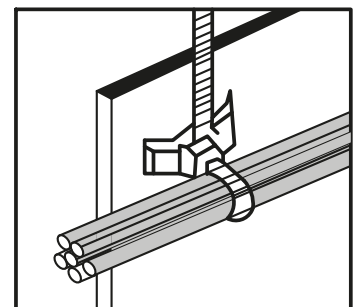
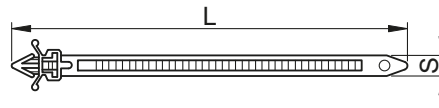
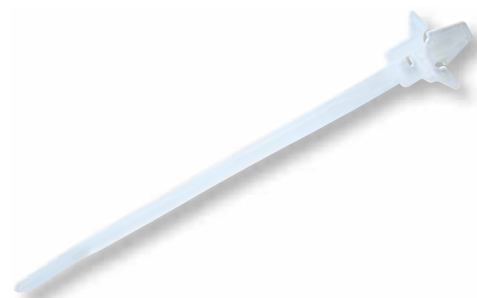

Jelzőcímkes kötegelők

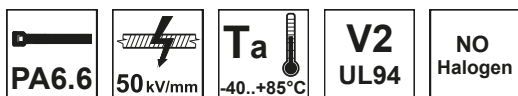

TRACON	L × S (mm)	a (mm)	b (mm)		
120J	110 × 2.5	8	25	1-20 mm	40 N
190J	190 × 3.6	27	13	10-48 mm	70 N
200J	210 × 2.5	15	30	5-45 mm	40 N

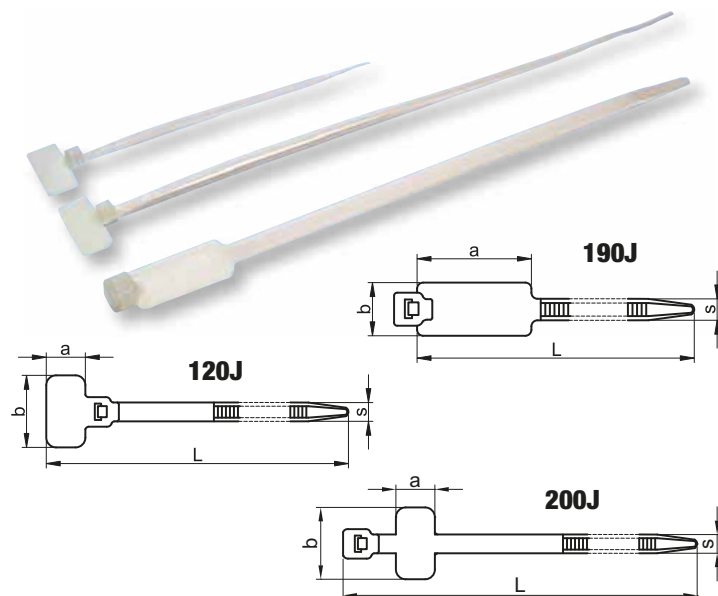

Acél kábelkötegelő

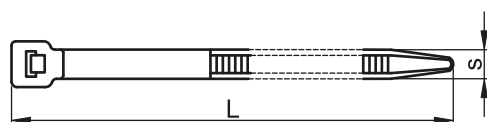

TRACON			
F125	125 × 4.6 mm	15 - 38 mm	350 N
F200	200 × 4.6 mm	15 - 61 mm	350 N
F201	200 × 7.9 mm	15 - 61 mm	450 N
F290	290 × 4.6 mm	15 - 90 mm	350 N
F291	290 × 7.9 mm	15 - 90 mm	450 N
F520	520 × 4.6 mm	15 - 163 mm	350 N
F521	520 × 7.9 mm	15 - 163 mm	450 N
F840	840 × 4.6 mm	15 - 265 mm	350 N
F841	840 × 7.9 mm	15 - 265 mm	450 N

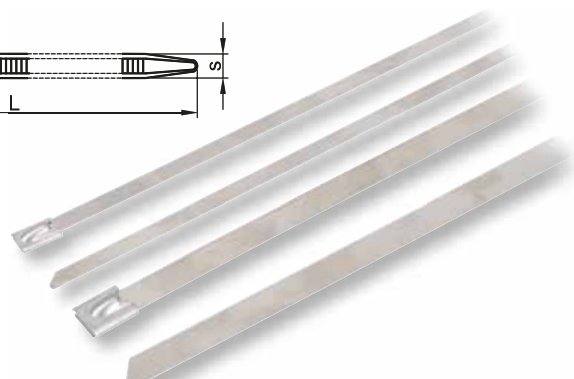
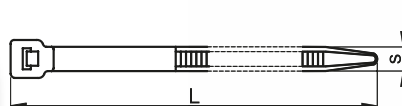

Csavarozható kábelkötegelő

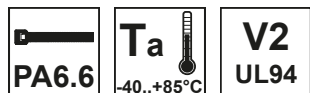

TRACON					
110-CS		110 × 2.5 mm	3 - 19 mm	45 N	M2.5
150-CS		150 × 3.6 mm	3 - 35 mm	80 N	M4
160-CS		160 × 4.8 mm	3 - 36 mm	110 N	M5
200-CS		200 × 4.8 mm	3 - 49 mm	110 N	M5
300-CS		300 × 4.8 mm	3 - 82 mm	110 N	M5
310-CS		300 × 7.6 mm	8 - 78 mm	250 N	M6
370-CS		370 × 4.8 mm	3 - 103 mm	110 N	M5
400-CS		400 × 7.6 mm	8 - 109 mm	250 N	M6

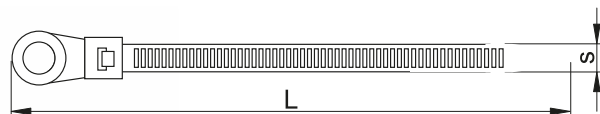

Peremre csíptethető talp, kábelkötegelővel

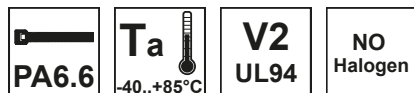

TRACON				
CSKT		4.8 × 200mm	3 - 49 mm	110 N

Maximális peremvastagság **3 mm**.



Tépőzáras kábelrendező



Piktogramok

C/O

TRACON			
TKR130		130 x 12,5 mm	35 mm
TKR200		200 x 12,5 mm	35 mm
TKR300		300 x 12,5 mm	89 mm
TKR310		300 x 17 mm	92 mm
TKR-12T		22,8 m x 12,5 mm	-
TKR-20T		25 m x 20 mm	-



TKR-12T
TKR-20T

Öntapadós kábeltartó



Piktogramok

C/O

TRACON		L (mm)	W (mm)	H (mm)
OKT15		15	24	9
OKT20		20	24	9
OKT25		25	24	9
OKT28		28	24	9

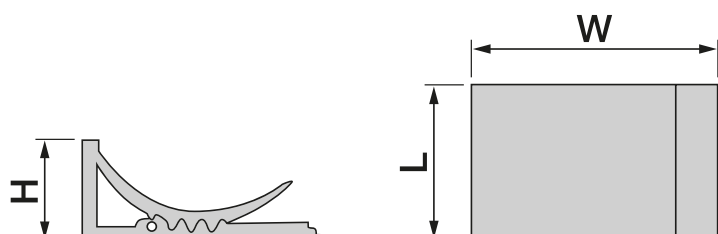

OKT28

OKT15

Csavarozható kábelkötegelő talpak

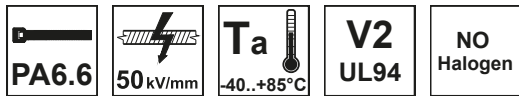

TRACON	a (mm)	b (mm)	L (mm)	d (mm)	D (mm)
CSTALP	15	10	5.1	3.5	7
CSTALP-3	12.8	7	4	3.3	5.8
CSTALP-2	23	16	9	6.3	9.8
CSTALP-4	16	11	5.3	3.5	7
CSTALP-5	22	15	8.3	5	9.5
CSTALP-6	26	16	9.5	5	10.7

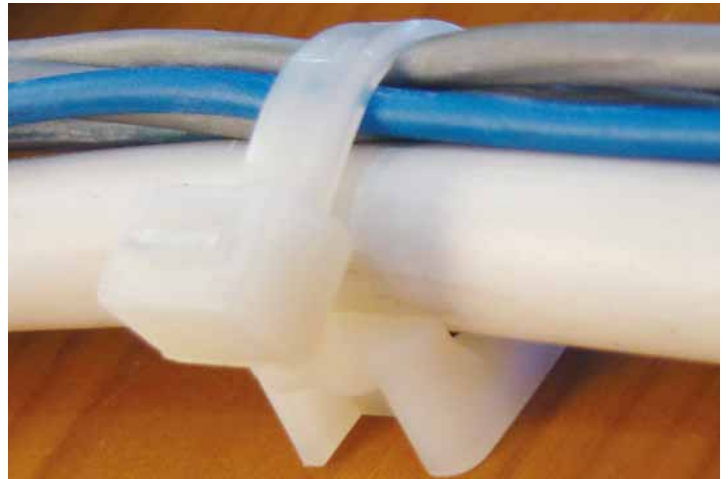
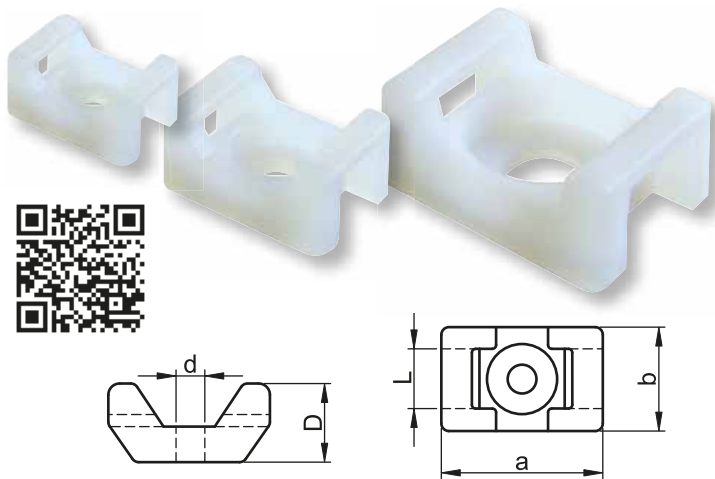

Öntapadós kétoldalról fűzhető kábelkötegelő talpak

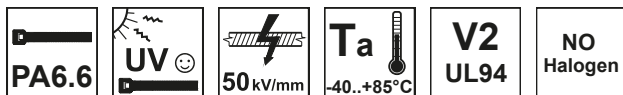

TRACON		a (mm)	b (mm)	L (mm)	d (mm)	D (mm)
TALP190-2		18.7	18.7	4	4.4	5.7
TALP191-2		18.7	18.7	4	4.4	5.7
TALP270-2		26.5	26.5	5.8	4.3	8.1
TALP271-2		26.5	26.5	5.8	4.3	8.1

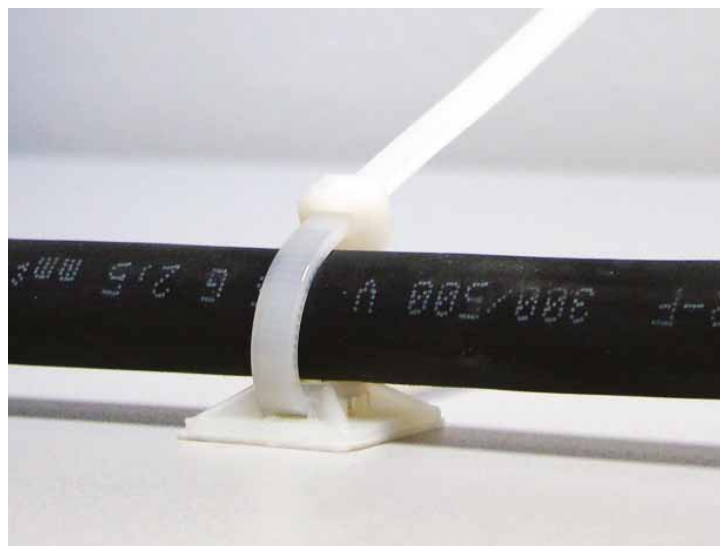
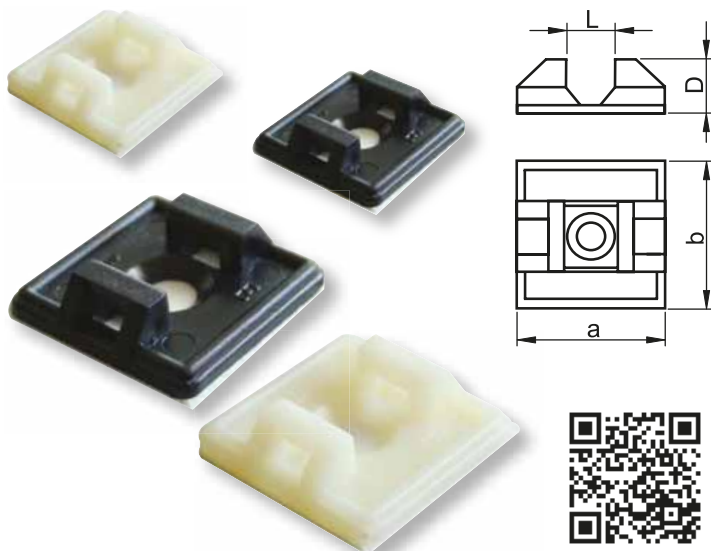

Öntapadós négyoldalról fűzhető kábelkötegelő talpak

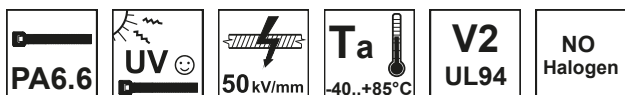

TRACON		a (mm)	b (mm)	L (mm)	d (mm)	D (mm)
TALP190		20	20	5	2.9	6.1
TALP191		20	20	5	2.9	6.1
TALP200		19	19	4.3	5	6
TALP201		19	19	4.3	5.7	6.5
TALP270		25	25	6.2	3.5	7.5
TALP271		25	25	6.2	3.5	7.5
TALP280		28	28	5.2	5.7	6.5
TALP281		28	28	5.2	5.7	6.5

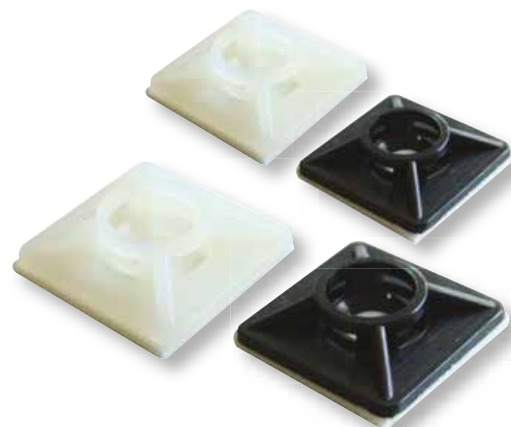
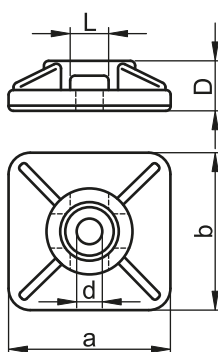

Normál beüthető kábelkötegelő tiplik

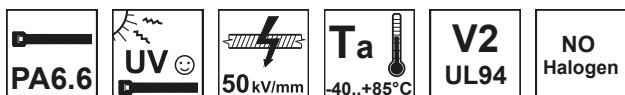

TRACON			a (mm)	b (mm)	c (mm)	W ₁ (mm)	W ₂ (mm)	L (mm)	D (mm)
5458		8 mm	10.6	6.3	3.1	12.8	12.6	43.8	9.9
5458N		7 mm	9.8	6.4	2.1	15.4	11.1	38.0	7.9
8138		7 mm	10.2	6.4	3	14.6	11	38	9.9
9843		8 mm	10.3	6.5	3.2	12.8	12.9	43.3	9.7

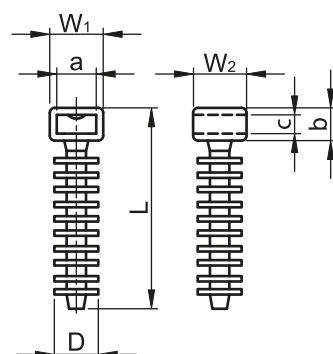
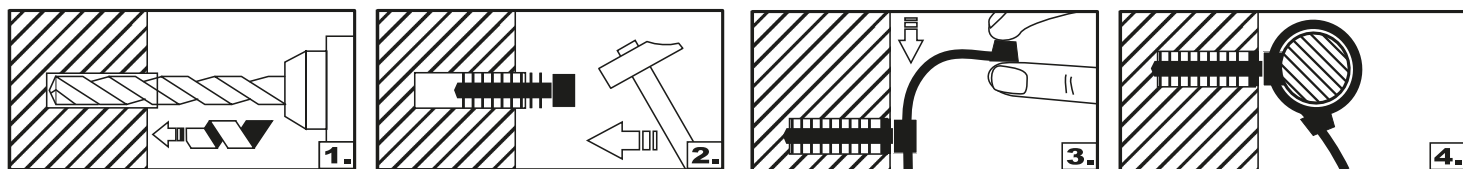

Kábelrögítő bilincs, szeggel

TRACON			a (mm)	b (mm)
100 pcs	20 pcs			
NOF	NOF-20		2.5	4.5
N1	N1-20		6	7.3
N2	N2-20		8	8.1
N3	N3-20		9	8.3
N4	N4-20		11	10

N1..N4

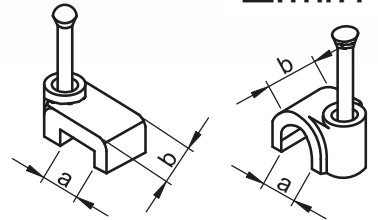

Csőrögző, sorolható klipsz



TRACON		D (mm)	W (mm)	L (mm)	H (mm)
CSS-16		16	29.3	12.9	21.7
CSS-20		20	33	12.9	24.2
CSS-25		25	37.5	12.9	27.9

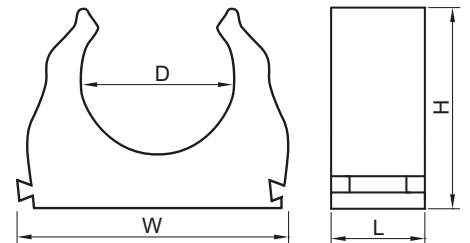



Kábel- és csőrögző klipsz

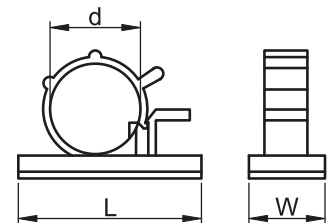

TRACON		d (mm)	W (mm)	L (mm)
TKCR-0708		7-8	20	25



Kábel- és csőrögztő (nyitható)







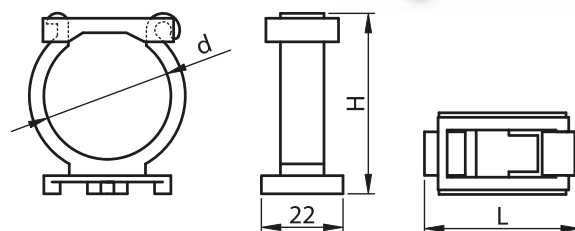



TRACON		d (mm)	L (mm)	H (mm)
TKCRZ-12		12	28	24.5
TKCRZ-15		15	28	28.5
TKCRZ-18		18	28	33
TKCRZ-22		22	34	37
TKCRZ-28		28	38,5	45
TKCRZ-32		32	38	47.5
TKCRZ-35		35	41	49



Cső és kábel szerű vezeték nyomóbilincs







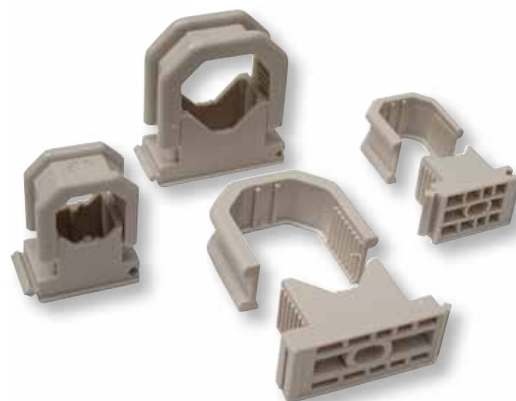
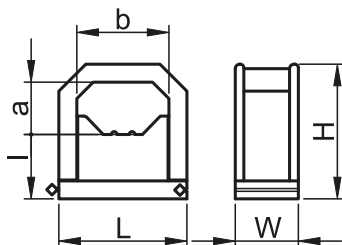

Piktogramok C/O

TRACON		a (mm)	b (mm)	L (mm)	l (mm)	H (mm)	W (mm)
BCSV-3		10-18	18.6	26.4	16.2	19.8-37.5	17.7
BCSV-4		19-31	28.8	39.4	15.1	39.5-51.6	18.2



Kábelrögztő tipli

Piktogramok C/O

TRACON		d ₁ (mm)	d ₂ (mm)	B (mm)	L (mm)
KRT		6	6	10	36.5
KRT8		8	7.7	12.2	42.7

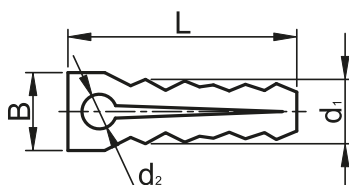

Peremes tipli, horog és kampó szerelvénnyel



Piktogramok

C/O

TRACON		D × L (mm)	d (mm)	l ₁ (mm)	l ₂ (mm)	B (mm)
T6H		6 × 30	3.3	37	24.2	15.4
T6K		6 × 30	3.3	38.5	10	13.4

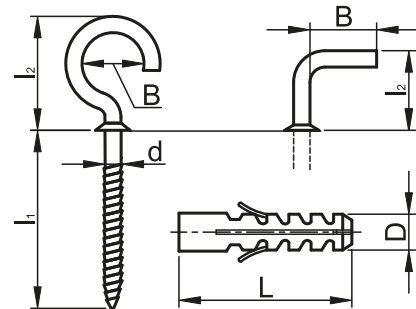

Peremes dübel, hatlapfejű peremes csavarral



TRACON	D × L (mm)	d × l (mm)
T10080P	10 × 80	6.8 × 95
T10100P	10 × 100	6.8 × 115
T10120P	10 × 120	6.8 × 135
T10140P	10 × 140	6.8 × 155
T10160P	10 × 160	6.8 × 175
T10200P	10 × 200	6.8 × 215
T10240P	10 × 240	6.8 × 255
T10300P	10 × 300	6.8 × 315

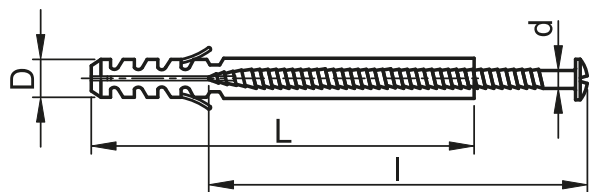

Beüthető gipszkarton tipli

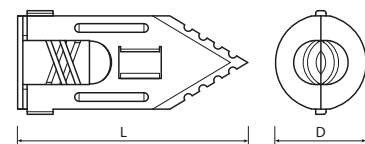

TRACON	D × L (mm)	
GTL30	10,5 × 30	3,5-4 mm
GTL40	10,5 × 40	3,5-4 mm
GTL43	16 × 43	3,5-4 mm



Nagy szilárdságú univerzális tipli

V2
UL94Ta
-40...+85°C

Piktogramok

C/O

TRACON	D x L (mm)	d x l (mm)*
T5-UNI	5 x 25	3.5 x 35
T6-UNI	6 x 30	4 x 40
T8-UNI	8 x 40	5 x 50
T10-UNI	10 x 50	6 x 60

* Az ajánlott csavar mérete.

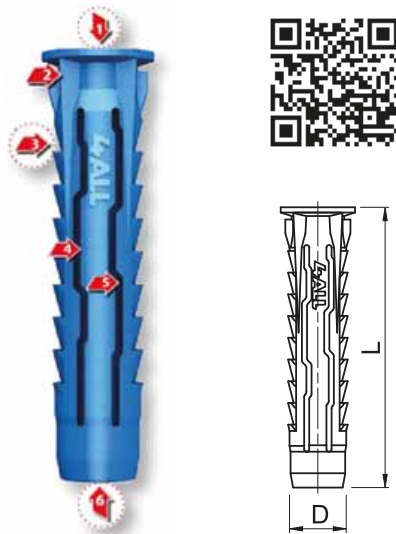

Egyedülálló belső kialakítás, amelybe nagyon jól illeszkedik a csavar.



Elfordulásgátló fülek, melyek minden anyagban megkapaszkodnak, még puha építőipari anyagokban is.



A fej alatti fogazás növeli a biztonságos rögzítést.



A terpesztő rész kialakítása lehetővé teszi, hogy üreges anyagban zsugorodva szétnyíljon, ezáltal kiválóan rögzít.



A 4 irányú szétnyílás alkalmassá teszi bármilyen anyagú és típusú falazatban történő használatra.



Az erősített kialakítású végződés biztosítja a csavar megfelelő tartását szereléskor.



Beton



Üreges falazóelem



Építőlemez

Gipszkarton tiplik

V2
UL94Ta
-40...+85°C

TRACON	Megnevezés	D x L (mm)	d x l (mm)*
GBT	Gipszkartonba becsavarható (önfúró) tipli	16 x 36	4 x 35
GSZT	Gipszkarton szárnyas tipli	10 x 55	4 x 50

* Az ajánlott csavar mérete.

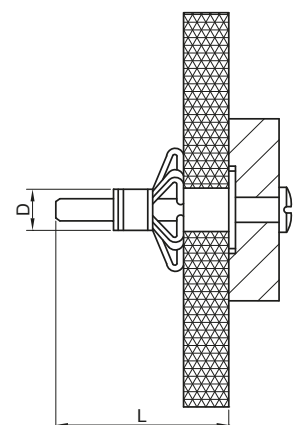

GSZT

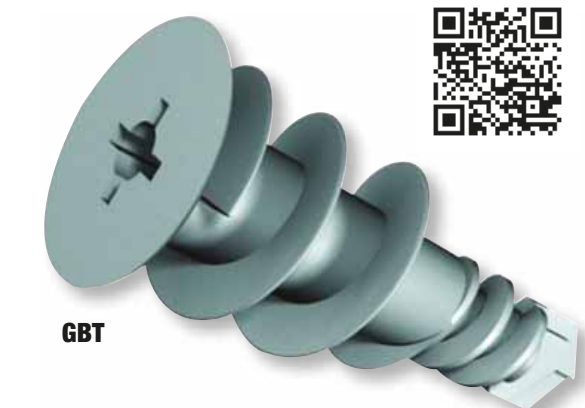

GBT

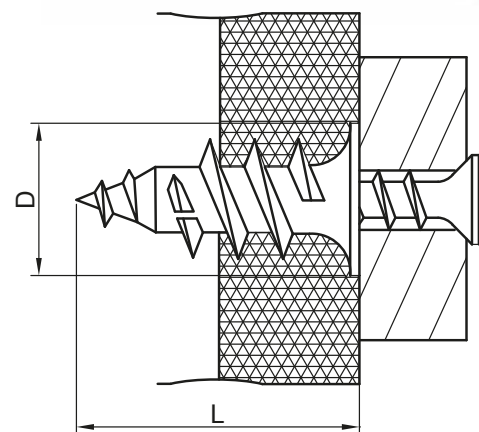

Négyszögletes tipli



V2
UL94

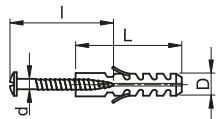

TRACON		D × L (mm)	d × l (mm)
TN6	TNCS6	6 × 23	2.6 × 30
TN8	TNCS8	8 × 34	3.5 × 38
TN10	TNCS10	10 × 42	4.4 × 46
TN12	TNCS12	12 × 52	5.4 × 61
TN14	-	14 × 65	-



Piktogramok

C/O

Beüthető tipli



V2
UL94

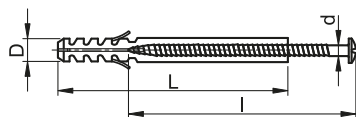

TRACON			TRACON		
	D × L (mm)	d × l (mm)		D × L (mm)	d × l (mm)
TB525	5 × 25	3.5 × 29	TB845	8 × 45	4.9 × 48
TB535	5 × 30	3.5 × 38	TB860	8 × 60	4.4 × 60
TB545	5 × 50	3.5 × 47	TB875	8 × 80	4.7 × 78
TB635	6 × 35	3.7 × 39	TB8100	8 × 100	4.7 × 102
TB645	6 × 40	3.7 × 48	TB8120	8 × 120	4.4 × 122
TB655	6 × 55	3.7 × 58	TB8135	8 × 135	4.4 × 137
TB670	6 × 80	3.2 × 83			



Hosszított tipli



V2
UL94

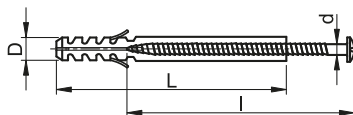

TRACON		D × L (mm)	d × l (mm)
-	THC8100	8 × 100	5.3 × 104
TH8120	THC8120	8 × 120	5.5 × 126
TH8135	THC8135	8 × 135	5.4 × 134
TH1080	THC1080	10 × 80	6.8 × 85
TH10100	THC10100	10 × 100	6.8 × 105
TH10115	THC10115	10 × 115	6.8 × 119
TH10135	THC10135	10 × 135	6.8 × 141
TH10160	THC10160	10 × 160	7 × 165



Normál tipli



V2
UL94

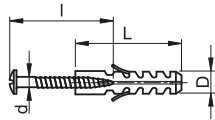

TRACON		D × L (mm)	d × l (mm)
		6 × 30	4 × 40
T6-PA	T6CS-PA	6 × 30	4 × 40
T8-PA	T8CS-PA	8 × 40	5 × 50
T10-PA	T10CS-PA	10 × 50	5.5 × 60
T12-PA	-	12 × 60	-
T14-PA	-	14 × 75	-

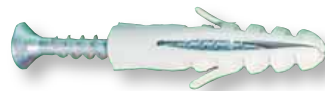

Piktogramok

C/O



Peremes tipli



V2
UL94

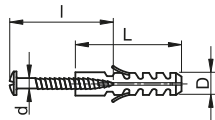

TRACON		D × L (mm)	d × l (mm)
-	T6PCS-PA	6 × 30	4 × 40
T8P-PA	T8PCS-PA	8 × 40	5 × 50
T10P-PA	T10PCSPA	10 × 50	5.5 × 60
T12P-PA	-	12 × 60	-



Önfeszítő tipli



V2
UL94

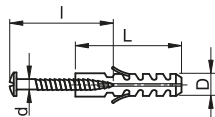

TRACON		D × L (mm)	d × l (mm)
		6 × 40	4 × 50
TOP6	TOPCS6	6 × 40	4 × 50
TOP8	TOPCS8	8 × 50	5 × 60
TOP10	TOPCS10	10 × 60	6 × 70



OLVASSA BE A KÓDOT!

- Nézze meg újdonságainkat
- Legyen naprakész

Kínálatunk gyorsan és folyamatosan fejlődik!
Katalógusunk a 2021. áprilisi állapotot tükrözi.

Naprakész információért
látogasson el honlapunkra!

Mennyezet csavar

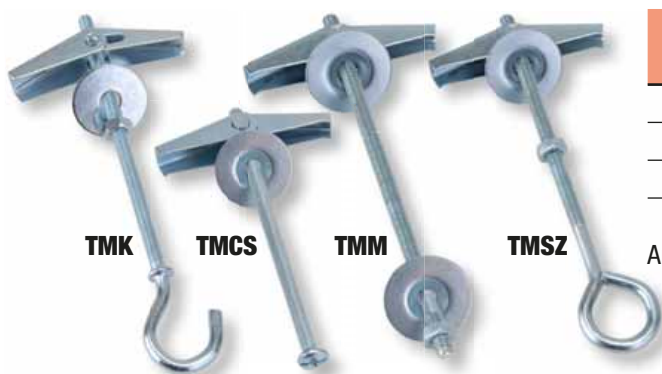

TMK

TMCS

TMM

TMSZ

TRACON	d (mm)	L (mm)	a (mm)	B (mm)	
TMK	M4	95	20	14	200 N
TMCS	M4	81	20	–	800 N
TMM	M4	100	20	–	800 N
TMSZ	M4	93	20	14	200 N

Anyag: acél, króm bevonattal

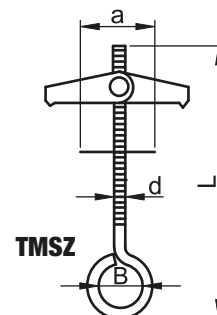
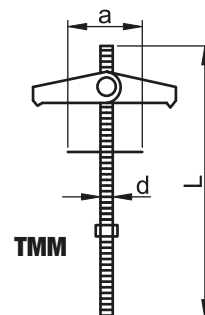
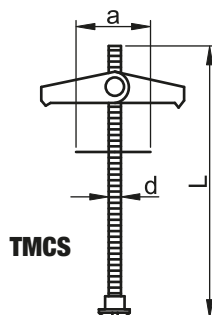
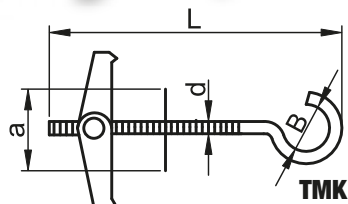

Kötélszív

TRACON	W (mm)	I (mm)	L (mm)	c (mm)	s (mm)	
SZIV-3	4.5	41.6	46.3	17	1	1 – 3 mm
SZIV-4	5.5	37.7	41.7	15	1	3 – 4 mm
SZIV-5	6.2	37.8	42.4	15	1	4 – 5 mm
SZIV-6	9	42.8	47.5	18.1	1	5 – 6 mm
SZIV-8	9.4	47.7	54.5	19.2	1.5	6 – 7 mm
SZIV-10	12.1	53.8	59.7	21.9	1.5	7 – 9 mm
SZIV-12	17.1	62.4	68.5	28.8	1.5	9 – 12 mm
SZIV-16	21.1	75.7	82.9	39.2	2	12 – 14 mm
SZIV-19	21.6	80.6	90.3	42.2	2.3	16 – 19 mm

Anyag: acél

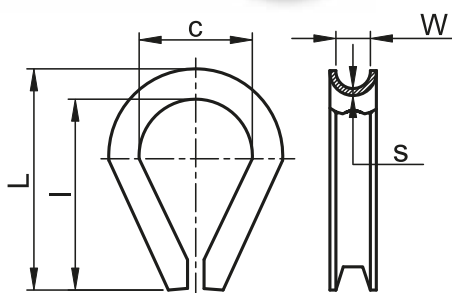

Kampó

TRACON	d (mm)	L (mm)	l (mm)	m (mm)	D (mm)	
HR3-25	3	26	20.2	3	7	320 N
HR3-30	3	31.1	25.5	4.8	8.8	320 N
HR4-30	4	33.4	25.5	4.8	10	575 N
HR4-35	4	35.3	27.5	5.2	10.2	575 N
HR4-40	4	41	33.3	5.9	10.9	575 N
HR5-45	4.8	46	36.7	6.6	12.5	730 N
HR5-50	5	53.5	44	10.3	15.3	885 N
HR6-80	6	80	69	12	24	1250 N
HR8-100	8	104	88	17	31	2000 N

Anyag: acél

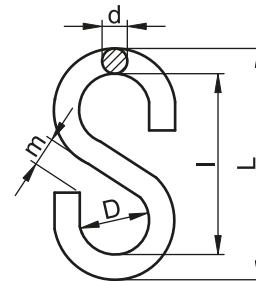

U sodronyszorító bilincs

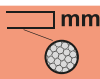
TRACON	d (mm)	D (mm)	W (mm)	H (mm)	h (mm)	L (mm)	 mm
U03	M4	5.4	9.5	20.4	7.3	18	2-3 mm
U05	M5	7.2	9.6	24.2	7.5	21.5	3.2-5 mm
U06	M5	8.0	11.2	24.2	9.5	23.8	4.5-7 mm
U08	M6	9	12.9	35.4	10.4	27.4	6.3-8 mm
U09	M8	10.5	16.6	37.3	12.7	33	8-9 mm
U11	M8	11	18.4	41	16	36.4	10-11 mm
U13	M10	14.8	20.6	54.7	18.7	42.2	12-14 mm
U14	M10	14.9	24.2	55.2	23	43.7	12-14 mm
U16	M10	18.2	26	62	25.2	49.9	14-16 mm
U19	M12	21.5	29.7	76.8	30.2	54.4	16-19 mm
U22	M12	21.5	31	77.8	33.2	56.7	19-22 mm
U25	M14	27.7	32.8	95.7	34.5	63.3	22-25 mm

Anyag: szorítócsavar – acél, test – temperált öntvény

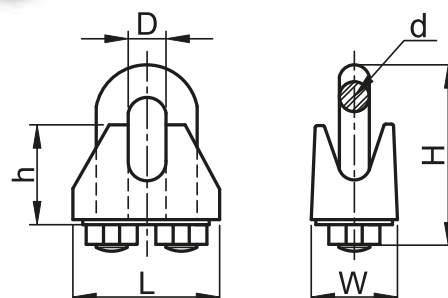

Szimpla sodronyszorító bilincs

TRACON	d (mm)	b (mm)	B (mm)	H (mm)	L (mm)	k (mm)
BSZ1-2	M4	5.1	13.6	6.1	17.2	13
BSZ1-3	M4	6.4	15.3	7	18.4	13.6
BSZ1-4	M5	10	16.6	6.5	21	17.4
BSZ1-5	M5	10.4	18.7	8.9	24.4	16.9
BSZ1-6	M6	12.5	23.3	9.6	30.2	21.6
BSZ1-8	M8	18.6	30.4	13.5	36.5	29.2

Anyag: acél

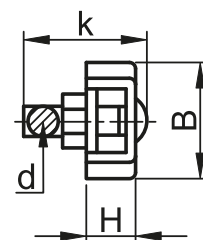
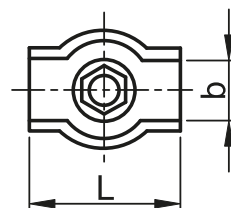

Dupla sodronyszorító bilincs

TRACON	d (mm)	b (mm)	B (mm)	H (mm)	L (mm)	k (mm)
BSZ2-2	M4	5.8	12.9	5	36.6	13.4
BSZ2-3	M4	6.4	15.3	6.7	35.2	13.5
BSZ2-4	M5	8.4	17.5	7.1	40	17.6
BSZ2-5	M5	11.9	20.4	8.8	48.8	19.6
BSZ2-6	M6	12.5	23.3	9.6	60.5	21.6
BSZ2-8	M8	18.6	30.4	13.5	73	29.2

Anyag: acél

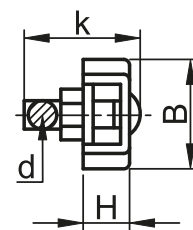
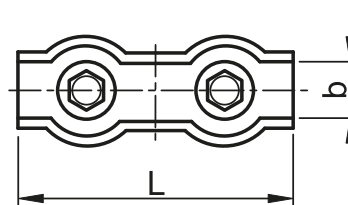

Acélmax sodronyszorító bilincs

TRACON	d (mm)	W (mm)	H (mm)	L (mm)	k (mm)	
AMAX3	M3	16.1	10.2	28.6	12.7	3 mm (1/8")
AMAX5	M5	17.5	10.7	30.5	12.4	5 mm (3/16")
AMAX6	M6	22.9	12.9	34.9	15.9	6 mm (1/4")

Anyag: acél

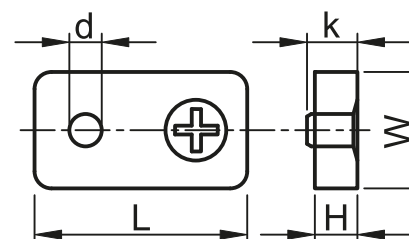

Rugós karabiner

TRACON	d (mm)	D (mm)	W (mm)	L (mm)	m (mm)	
RKARA4	4.5	5.8	21.1	42.0	5.5	300 N
RKARA5	5	6.6	26	51.3	7.2	500 N
RKARA6	6	6.9	30.2	62.3	7.7	800 N
RKARA7	7	7.8	35.1	70.7	8.7	1100 N
RKARA8	8	8.1	40.4	80.5	10.2	1400 N
RKARA9	9	9.7	45	90.3	11.7	1700 N
RKARA10	10	11.1	47.3	99.8	13.4	2100 N
RKARA11	11	12.3	57.3	121.2	16.5	2500 N
RKARA12	12	13.9	63.2	142.5	20.8	2700 N
RKARA13	13	15.8	72.8	149.4	24.1	3000 N

Anyag: acél

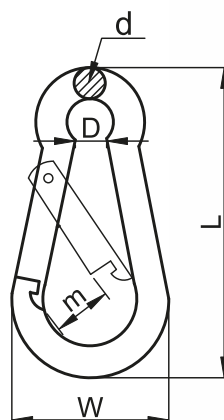

Csavaros karabiner

TRACON	d (mm)	D (mm)	W (mm)	L (mm)	
CSKARA3,5	3.5	10.8	17.9	35.5	420 N
CSKARA4	4	11.6	19.7	40.6	850 N
CSKARA5	5	13.6	23.5	50.9	1270 N
CSKARA6	6	14.7	26.7	58.3	1700 N
CSKARA7	7	18.4	32	68.2	2550 N
CSKARA8	8	19.6	36	73.8	3100 N
CSKARA9	9	20.6	39.2	82.2	4250 N
CSKARA10	10	21.6	42.4	89.6	5100 N
CSKARA12	12	23.5	48.3	106.2	6400 N

Anyag: acél

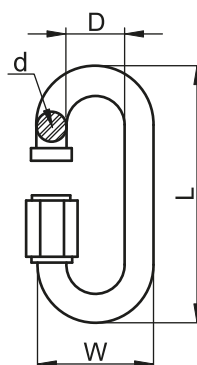

Kötélfeszítő

TRACON			d (mm)	l (mm)	L (mm)	D (mm)	
			5	50	92.6	7.8	750 N
			5	70	113	8	770 N
			6	60	112	10	1050 N
			6	100	154	10.2	1800 N
		-	8	70	137	12.3	1200 N
			8	110	176	12.3	2000 N
			10	120	194	13.3	3000 N
			12	130	224	18.3	4450 N
-			16	140	265	22	5950 N

Anyag: Anyag: feszítőcsavar – acél, test – temperált öntvény



FSS



FSH



FHH

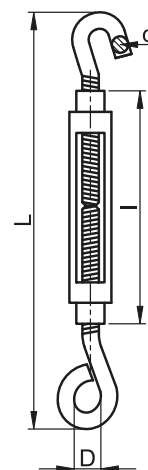

Vezetékösszefogó spirál

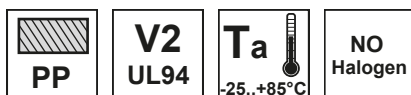

TRACON	d (mm)	D (mm)	s (mm)		
	6.2	8.6	1.9	1 m	6 mm
	8	10.9	2.4	1 m	8 mm
	10	13.2	2.9	1 m	10 mm
	12	15.4	2.9	1 m	12 mm
	15	17.1	2.9	1 m	15 mm
	20	24	3	1 m	20 mm
	25	28.7	3	1 m	25 mm

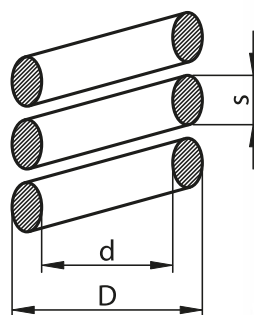

OLVASSA BE A KÓDOT!

- Nézze meg újdonságainkat
- Legyen naprakész

Kínálatunk gyorsan és folyamatosan fejlődik!
Katalógusunk a 2021. áprilisi állapotot tükrözi.

Naprakész információért
látogasson el honlapunkra!

Vezetékösszefogó szalagspirál

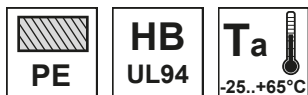

TRACON		D (mm)	d (mm)	W (mm)		
KSPI-4N	KSPI-4F	4.5	3.2	6.8	10 m	4...20 mm
KSPI-6N	KSPI-6F	6.9	5.3	10.3	10 m	7...40 mm
KSPI-8N	KSPI-8F	8.4	6.6	11.7	10 m	12...50 mm
KSPI-10N	KSPI-10F	10.2	8.2	13.4	10 m	13...70 mm
KSPI-12N	KSPI-12F	12.2	9.6	15.9	10 m	15...80 mm
KSPI-16N	KSPI-16F	15.7	12.4	21.6	10 m	20...120 mm

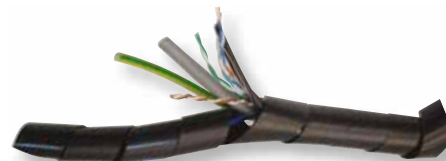
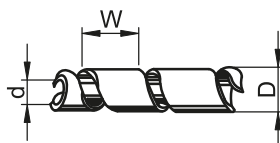

Műanyag kábelharisnya

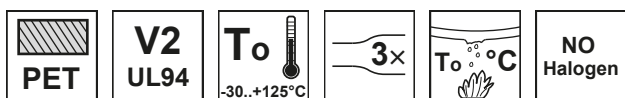

TRACON		
TKH-003	3 mm	2.4 – 6.4 mm
TKH-010	10 mm	4.8 – 15.9 mm
TKH-016	16 mm	9.5 – 25.4 mm
TKH-025	25 mm	15.9 – 36.1 mm
TKH-032	32 mm	19.1 – 44.5 mm

Előnye, hogy a kábel mechanikai védelme mellett magas fokú hajlékony-sága és tágulási képessége révén kiválóan követi a kábelek nyomvonalát és az esetleges keresztmetszet változásokat. Méretre vágását speciális pákaheggyel vagy forró késsel lehet elvégezni, így a vágási felület nem pöndörödik fel, és nem porlad. A szőtt szerkezet nem köti meg sem a hőt, sem a párákat.



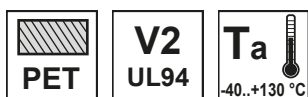

Önzáró fonott kábelharisnya

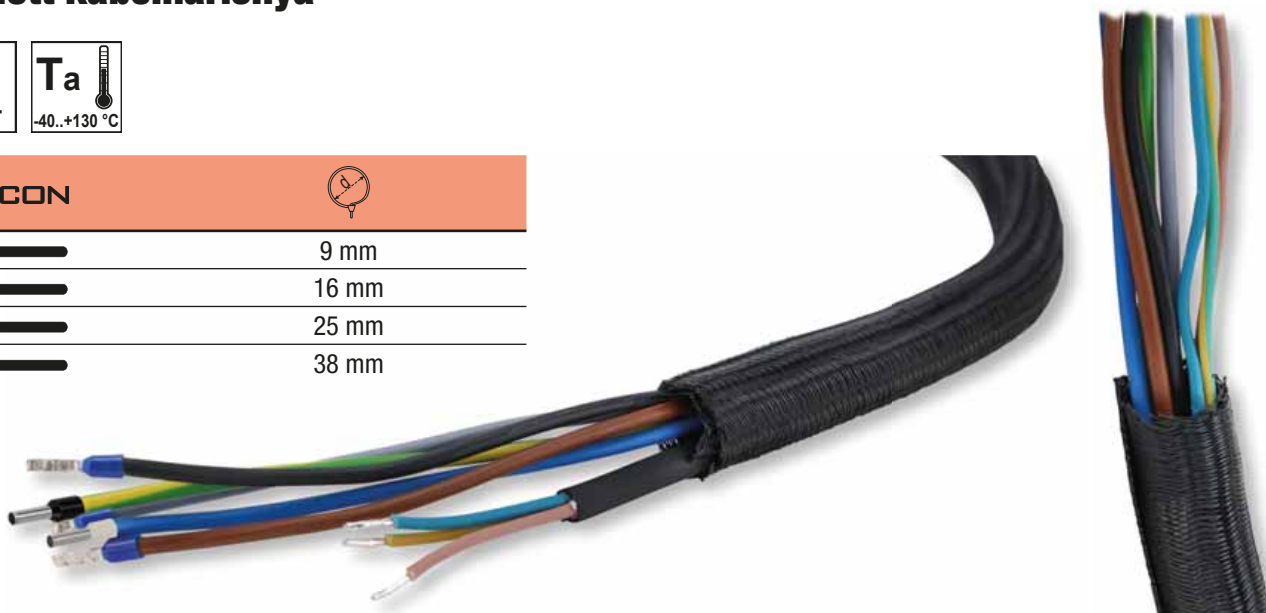

TRACON	
OFK9	9 mm
OFK16	16 mm
OFK25	25 mm
OFK38	38 mm



Jelölőplomba

TRACON		L (mm)	a (mm)	b (mm)	
JPL1		230	18	54	80 N
JPL2		330	18	54	80 N
JPL3		415	21	79	200 N



Jelöléstechnikai eszköz, amely egyediségével (egyedi sorszám) ellenőrizhetővé, nyomkövethetővé teszi a védett tárgyhoz való hozzáférést. A plombák felhelyezése és levétele igen egyszerű, nem igényel szerszámokat, segédanyagot. Műanyag plombáink feje fém- vagy kemény műanyag betétesek, így hőre nem lágyulnak, a plombák szétnyitása roncsolás nélkül lehetetlen.

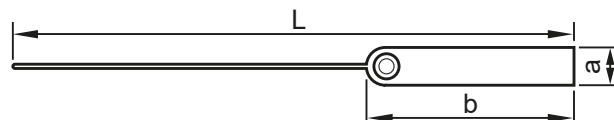

Mérőóra plomba

TRACON		a (mm)	b (mm)
MP1		30,5	21
MP2		27	13

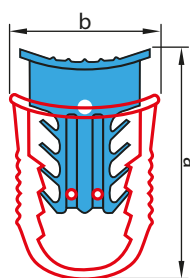

Mérőóra plombáink alkalmasak elosztószekrények, gázórák és egyéb mérőórák jelképes védelmének ellátására. Ajánljuk minden olyan helyre, ahol szimbolikus zárás a cél, de nem szeretnénk, hogy a plomba idő előtt leszakadjon. Felhelyezéséhez nem szükséges szerszám vagy segédanyag.

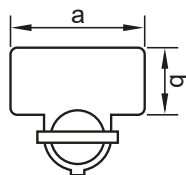

OLVASSA BE A KÓDOT!

- Nézze meg újdonságainkat
- Legyen naprakész

Kínálatunk gyorsan és folyamatosan fejlődik!
Katalógusunk a 2021. áprilisi állapotot tükrözi.

Naprakész információért
látogasson el honlapunkra!

TRACON
.....ELECTRIC®

EVO

MODULÁRIS TERMÉKCSALÁD



F/14-F/28

Táblázat fejlécek piktogramjai

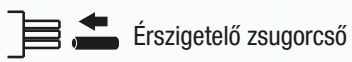

Érszigetelő zsugorcső

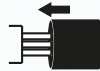

Köpenyszigetelő zsugorcső



Főkábel



Leágazó kábel



Szilárdulási idő



Úrtartalom



Vízfelvétel 42 nap alatt
50 °C-on



Beköthető vezeték-
keresztmetszet

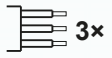

3x Háromerű kábel



Tömeg

Műszaki adatok piktogramjai



2:1

Zsugorodási arány



Környezeti
hőmérséklet

-40..+105°C



Tárolási hőmérséklet

-20..+45 °C



Zsugorodási
hőmérséklet

min.135°C



1m

Hosszúság



Polyolefin

Anyag: Polyolefin



NO
Halogen

Nem tartalmaz
halogén elemeket



UV

UV-álló



PE

Anyag: Polietilén



V0
UL94

Lángállóság UL94
szerint



20kV/mm

Villamos szilárdság

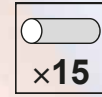

x15

Készlet tartalma



Silicon
free

Szilikonmentes



Vízálló



SR

Anyag: Szilikon gumi

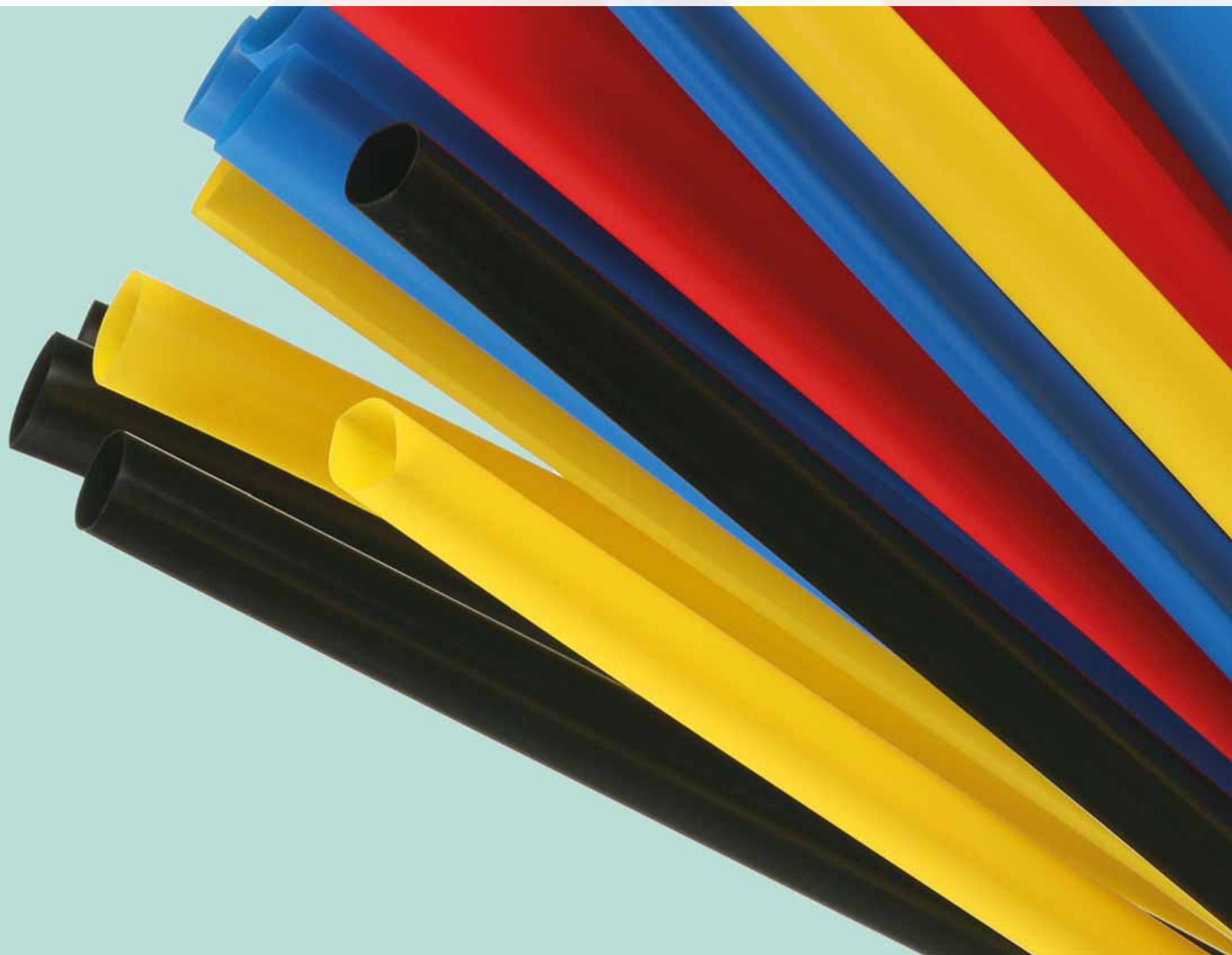

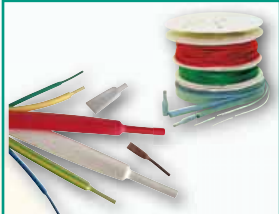

2:1 zsugorodási arányú vékonyfalú zsugorcsovok **2**



3:1 zsugorodási arányú vékonyfalú zsugorcsovok **3**



Közepes- és vastagfalú zsugorcsovok **4**

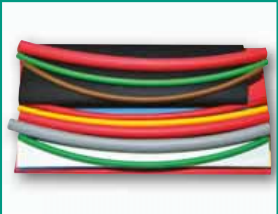

Zsugorcso barkács készlet **4**



Darabolt zsugorcso készletek **5**

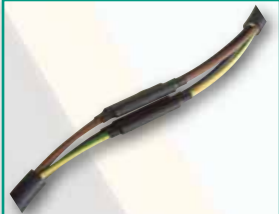

Kisfeszültségű kötészkezetek 0,6/1 kV-os árnyékolatlan kábelekhez **6**



Kisfeszültségű kötészkezetek 0,6/1 kV-os huzalárnyékolású kábelekhez **7**



Kisfeszültségű kötészkezetek 0,6/1 kV-os szalagárnyékolású kábelekhez **8**



Kétágú végelzáró **9**



Háromágú végelzáró **9**



Négyágú végelzáró **10**



Hőlégfúvó **10**



Ötágú végelzáró **11**



Szabadtéri végelzáró készletek 0,6/1 kV-os árnyékolatlan kábelekhez **11**



Véglzáró készletek 0,6/1 kV-os 4-erű huzalárnyékolású kábelekhez **12**



Véglzáró készlet 0,6/1 kV-os 4-erű szalagárnyékolású kábelekhez **13**



Kiöntőgyantás egyenes kötészkezetek **14**



Kiöntőgyantás „Y” kötészkezetek **15**



Záró sapkák **16**



Cipzárás zsugor javító készletek **16**



Hidegzsugor cső **17**

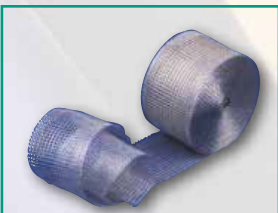

Rézharisnya szalag **18**

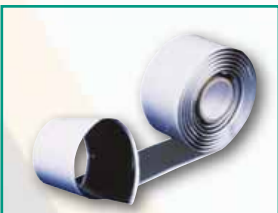

Tömítő szalag **18**



Térkitöltő masszaszalag **18**



Földelő rugó **18**

D

2:1 zsugorodási arányú vékonyfalú zsugorcsovek, ragasztó nélkül



TRACON											D ₁	D ₂	S
											(mm)	(mm)	(mm)
ZS016	ZS016SZ	-	ZS016K	-	ZS016P	ZS016S	ZS016Z	ZS016FEH	-	ZS016LIL	1.6	0.8	0.45
ZS024	ZS024SZ	ZS024B	ZS024K	ZS024ZS	ZS024P	ZS024S	ZS024Z	ZS024FEH	ZS024N	ZS024LIL	2.4	1.2	0.43
ZS032	ZS032SZ	ZS032B	ZS032K	ZS032ZS	ZS032P	ZS032S	ZS032Z	ZS032FEH	ZS032N	ZS032LIL	3.2	1.6	0.43
ZS048	ZS048SZ	ZS048B	ZS048K	ZS048ZS	ZS048P	ZS048S	ZS048Z	ZS048FEH	ZS048N	ZS048LIL	4.8	2.4	0.43
ZS064	ZS064SZ	ZS064B	ZS064K	ZS064ZS	ZS064P	ZS064S	ZS064Z	ZS064FEH	ZS064N	ZS064LIL	6.4	3.2	0.56
ZS095	ZS095SZ	ZS095B	ZS095K	ZS095ZS	ZS095P	ZS095S	ZS095Z	ZS095FEH	ZS095N	ZS095LIL	9.5	4.8	0.56
ZS127	ZS127SZ	ZS127B	ZS127K	ZS127ZS	ZS127P	ZS127S	ZS127Z	ZS127FEH	ZS127N	ZS127LIL	12.7	6.4	0.56
ZS190	ZS190SZ	ZS190B	ZS190K	ZS190ZS	ZS190P	ZS190S	ZS190Z	ZS190FEH	ZS190N	ZS190LIL	19	9.5	0.7
ZS254	ZS254SZ	ZS254B	ZS254K	ZS254ZS	ZS254P	ZS254S	ZS254Z	ZS254FEH	ZS254N	ZS254LIL	25.4	12.7	0.76
ZS381	ZS381SZ	ZS381B	ZS381K	ZS381ZS	ZS381P	ZS381S	ZS381Z	ZS381FEH	ZS381N	ZS381LIL	38.1	19	0.86
ZS508	ZS508SZ	ZS508B	ZS508K	ZS508ZS	ZS508P	ZS508S	ZS508Z	ZS508FEH	ZS508N	-	50.8	25.4	0.96
ZS760	-	-	-	-	-	-	-	-	-	-	76.2	38.1	1.2
ZS1020	ZS1020SZ	-	-	-	ZS1020P	ZS1020S	ZS1020Z	-	-	-	101.6	50.8	1.15

Dobos változat rendelése esetén a kód után -D adódik, pl. ZS016-D.

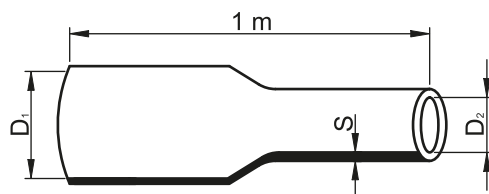
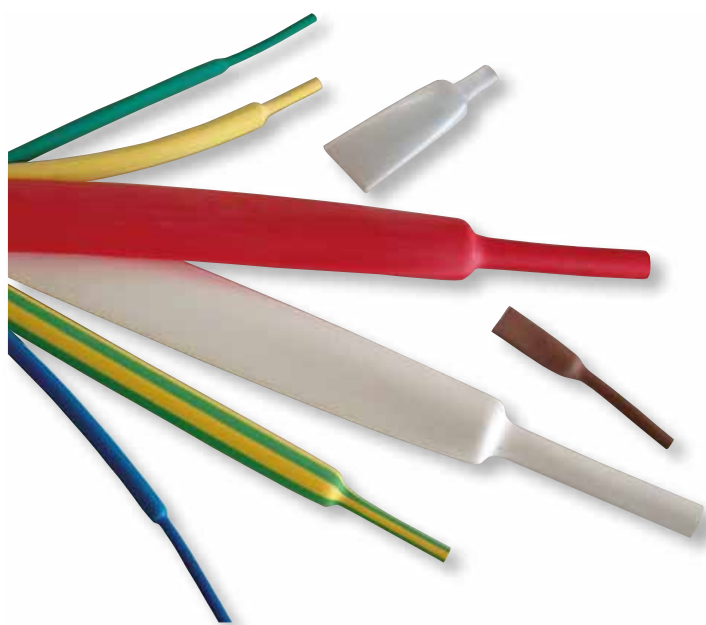

D1 – zsugorodás előtti belső átmérő
 D2 – szabad zsugorítás utáni belső átmérő
 S – szabad zsugorítás utáni falvastagság

RELEVANT STANDARD
EN 60684

UL CERTIFICATE NO.
YDPU2.E204071

TÜV MEEI TEST DOCUMENTATION
K-08382

Felhasználási terület

- kábelek és vezetékek villamos szigetelése
- vezetékek szigetelési hibáinak javítása
- kábelek és vezetékek korrózió elleni védelme
- kábelek és vezetékek nedvesség ill. külső időjárási viszonyok elleni védelme
- kábelsaruk villamos szigetelése
- elektronikai alkatrészek aktív részeinek védelme
- fém rudak, szerszámnyelvek korrózió elleni védelme
- dekoratív célok

3:1 zsugorodási arányú vékonyfalú zsugorcsövek



Ragasztó nélküli kivitel

TRACON	D ₁ (mm)	D ₂ (mm)	S (mm)
ZSV30	3	1	0.55
ZSV48	4.8	1.6	0.60
ZSV60	6	2	0.65
ZSV90	9	3	0.75
ZSV120	12	4	0.75
ZSV180	19	6	0.95
ZSV240	24	8	1.15
ZSV390	39	13	1.30

Ragasztós kivitel



TRACON	D ₁ (mm)	D ₂ (mm)	S (mm)
ZSVR30	3	1	1
ZSVR48	4.8	1.6	1
ZSVR60	6	2	1
ZSVR90	9	3	1.4
ZSVR120	12	4	1.6
ZSVR190	19	6	2.15
ZSVR240	24	8	2.4
ZSVR390	39	13	2.4



RELEVANT STANDARD
EN 60684

TÜV MEEI TEST DOCUMENTATION
K-08382

UL CERTIFICATE NO.
YDPU2.E204071

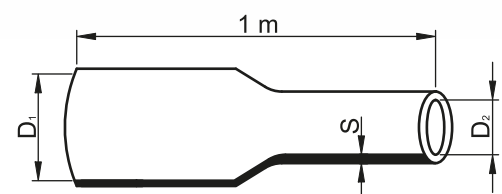

Közepes- és vastagfalú zsugorcsovék, ragasztós kivitel

Közepesfalú típusok

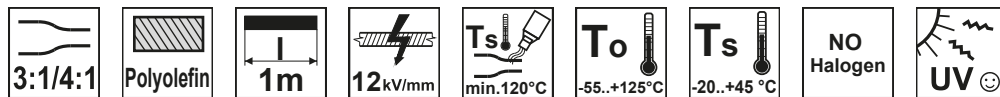

TRACON	D ₁ (mm)	D ₂ (mm)	S (mm)
ZS8/2R	8	2	1.7
ZS12/3R	12	3	1.5
ZS16/4R	16	4	2
ZS19/6R	19	6	2.5
ZS30/8R	30	8	2.5
ZS40/12R	40	12	3
ZS50/16R	50	16	3
ZS63/19R	63	19	3.5
ZS75/22R	75	22	3.5
ZS95/30R	95	30	4
ZS115/34R	115	34	4
ZS140/42R	140	42	5.5
ZS175/55R	175	55	4

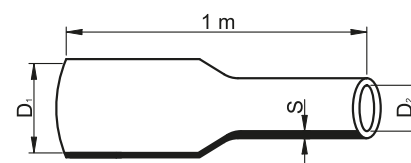

UL CERTIFICATE NO.
YDPU2.E204071

TÜV MEEI TEST DOCUMENTATION
K-08382

RELEVANT STANDARD
EN 60684

Vastagfalú típusok

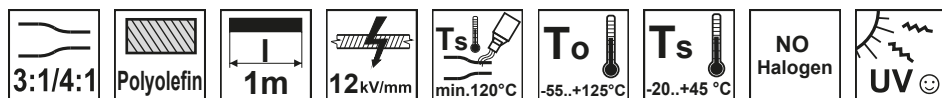

TRACON	D ₁ (mm)	D ₂ (mm)	S (mm)
ZSB33/8R	33	8	3.2
ZSB51/16R	51	16	6
ZSB85/25R	85	25	6.5
ZSB130/36R	130	36	6.5
ZSB180/50R	180	50	4.3

ZSB-SET – Zsugorcsovő barkács készlet

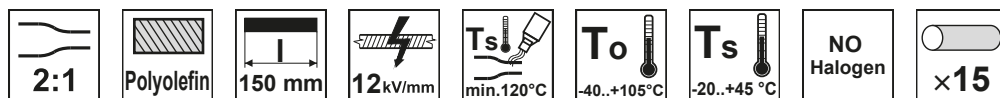

ZSB-SET



ZSBB-SET

TRACON	X	
ZSB-SET	15 × 150 mm	
ZSBB-SET	15 × 150 mm	

Vezetékek szigetelési hibáinak kijavítására szolgál.

- Készletek tartalma: 15 db vékonyfalú zsugorcsovő
- Anyag: 2:1 zsugorodási arányú, halogén elemeket nem tartalmazó poliolefin
- Kapható: 150 mm-es darabokban, melyek különböző méretűek

RELEVANT STANDARD
EN 60684

Piktogramok **D/O**

Darabolt zsugorcső készletek, ragasztós kivitel



TRACON	mm ²	Cable		Sleeve		Sleeve	
		d ₁ /d ₂ (mm)	l (mm)	×	D ₁ /D ₂ (mm)	L (mm)	×
ZSRSET3-1,5	3 × 1.5	8/2	50	3	19/6	200	1
ZSRSET3-2,5	3 × 2.5	8/2	50	3	19/6	250	1
ZSRSET4-1,5	4 × 1.5	8/2	50	4	19/6	200	1
ZSRSET4-2,5	4 × 2.5	8/2	50	4	19/6	250	1
ZSRSET4-4	4 × 4	8/2	100	4	30/8	250	1
ZSRSET4-6	4 × 6	8/2	100	4	30/8	330	1
ZSRSET4-10	4 × 10	12/3	100	4	40/12	500	1
ZSRSET4-16	4 × 16	12/3	200	4	40/12	500	1
ZSRSET4-25	4 × 25	19/6	200	4	50/16	500	1
ZSRSET4-35	4 × 35	19/6	200	4	50/16	1000	1
ZSRSET4-50	4 × 50	19/6	200	4	63/19	1000	1
ZSRSET4-70	4 × 70	30/8	250	4	63/19	1000	1
ZSRSET4-95	4 × 95	30/8	250	4	75/22	1000	1
ZSRSET4-120	4 × 120	30/8	250	4	95/30	1000	1
ZSRSET4-150	4 × 150	40/12	250	4	95/30	1000	1
ZSRSET4-185	4 × 185	40/12	250	4	115/34	1000	1
ZSRSET4-240	4 × 240	40/12	330	4	115/34	1000	1
ZSRSET5-1,5	5 × 1.5	8/2	50	5	19/6	200	1
ZSRSET5-2,5	5 × 2.5	8/2	50	5	19/6	250	1
ZSRSET5-4	5 × 4	8/2	100	5	30/8	250	1
ZSRSET5-6	5 × 6	8/2	100	5	30/8	330	1
ZSRSET5-10	5 × 10	12/3	100	5	40/12	500	1
ZSRSET5-16	5 × 16	12/3	200	5	40/12	500	1
ZSRSET5-25	5 × 25	19/6	200	5	50/16	500	1
ZSRSET5-35	5 × 35	19/6	200	5	50/16	1000	1
ZSRSET5-50	5 × 50	19/6	200	5	63/19	1000	1
ZSRSET5-70	5 × 70	30/8	250	5	63/19	1000	1

Az összekötni kívánt kábelerek keresztmetszete alapján kell az érösszekötő réz ill. alumínium toldóhüvelyt kiválasztani (nem része a garnitúrának).

Szigeteletlen toldóhüvely

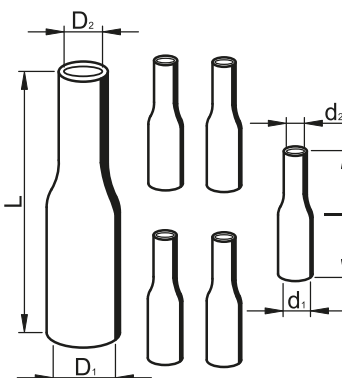

A/10-A/11

RELEVANT STANDARD
EN 60684TÜV MEEI TEST DOCUMENTATION
V-10237

Kisfeszültségű kötőeszközök 0,6/1 kV-os árnyékolatlan kábelekhez



Közepesfalú burkoló zsugorcsővel ellátott kivitelek

TRACON	mm ²	d ₁ /d ₂ (mm)	l (mm)	×	D ₁ /D ₂ (mm)	L (mm)	×
ZSRSET-1	4 × 6 – 4 × 25	12/3	100	4	40/12	500	1
ZSRSET-2A	4 × 25 – 4 × 35	19/6	200	4	50/16	1000	1
ZSRSET-2B	4 × 50 – 4 × 70	30/8	200	4	63/19	1000	1
ZSRSET-2	4 × 35 – 4 × 120	30/8	200	4	75/22	1000	1
ZSRSET-3	4 × 150 – 4 × 240	40/12	250	4	140/42	1000	1
ZSRSET5-1	5 × 6 – 5 × 25	12/3	100	5	40/12	500	1
ZSRSET5-2A	5 × 25 – 5 × 35	19/6	200	5	50/16	1000	1
ZSRSET5-2B	5 × 50 – 5 × 70	30/8	200	5	63/19	1000	1
ZSRSET5-2	5 × 35 – 5 × 120	30/8	200	5	75/22	1000	1
ZSRSET5-3	5 × 150 – 5 × 240	40/12	250	5	140/42	1000	1

Vastagfalú burkoló zsugorcsővel ellátott kivitelek

TRACON	mm ²	d ₁ /d ₂ (mm)	l (mm)	×	D ₁ /D ₂ (mm)	L (mm)	×
ZSRSET-1FK	4 × 6 – 4 × 25	19/6	150	4	51/16	500	1
ZSRSET-2FK	4 × 35 – 4 × 120	30/8	200	4	85/25	1000	1
ZSRSET-3FK	4 × 150 – 4 × 240	50/16	300	4	130/36	1000	1
ZSRSET5-1FK	5 × 6 – 5 × 25	19/6	150	5	51/16	500	1
ZSRSET5-2FK	5 × 35 – 5 × 120	30/8	200	5	85/25	1000	1
ZSRSET5-3FK	5 × 150 – 5 × 240	50/16	300	5	130/36	1000	1

Az összekötni kívánt kábelek keresztmetszete alapján kell az erősszekítő réz ill. alumínium toldóhüvelyt kiválasztani (nem része a garnitúrának).

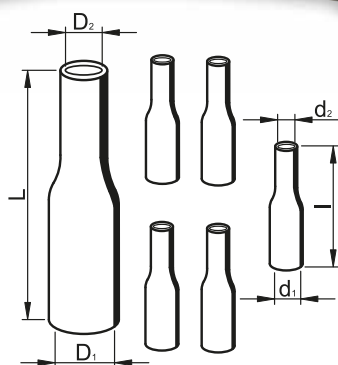

A garnitúra tartalma:

- 1 db szerelési útmutató
- 1 db burkoló, közepesfalú/vastagfalú zsugorcső, belső, hőre olvadó ragasztóval
- 4 ill. 5 db érszigetelő zsugorcső közepesfalú, belső, hőre olvadó ragasztóval

- d₁ – érszigetelő zsugorcső zsugorodás előtti belső átmérője
- d₂ – érszigetelő zsugorcső szabad zsugorítás utáni belső átmérője
- D₁ – köpenyszigetelő zsugorcső zsugorodás előtti belső átmérője
- D₂ – köpenyszigetelő zsugorcső szabad zsugorítás utáni belső átmérője

RELEVANT STANDARD
EN 60684

TÜV MEEI TEST DOCUMENTATION
V-10237



OLVASSA BE A KÓDOT!

- Nézze meg újdonságainkat
- Legyen naprakész

Kínálatunk gyorsan és folyamatosan fejlődik!
Katalógusunk a 2021. áprilisi állapotot tükrözi.
Naprakész információért látogasson el honlapunkra!

Kisfeszültségű kötőeszközök 0,6/1 kV-os huzalárnyékolású kábelekhez



Érszigetelő ill. köpenyszigetelő zsugorcsovek

TRACON	mm ²	d ₁ /d ₂ (mm)	l (mm)	X	D ₁ /D ₂ (mm)	L (mm)	X
ZSRSET-1DA	4 × 6 – 4 × 25	19/6	150	4	51/16	500	1
ZSRSET-2DA	4 × 35 – 4 × 120	30/8	200	4	85/25	1000	1
ZSRSET-3DA	4 × 150 – 4 × 240	50/16	300	4	130/36	1000	1

Árnyékolást helyreállító elemek

TRACON	Kábel keresztmetszet (mm ²)	Árnyékolás		Térkitöltés		Egyéb
		Toldóhüvely keresztmetszet (mm ²)	Darabszám	PVC párnázó szalag (mm)	Tekerics szám	Csiszoló vászon méretei
ZSRSET-1DA	4 × 6 – 4 × 25	10	1	0.4 × 50 × 5000	1	600 mm × 25 mm
ZSRSET-2DA	4 × 35 – 4 × 120	25-35	2	0.4 × 50 × 5000	1	600 mm × 25 mm
ZSRSET-3DA	5 × 150 – 5 × 240	50	1	0.4 × 50 × 5000	1	800 mm × 25 mm

Az összekötni kívánt kábelek keresztmetszete alapján kell az erősszekötő réz ill. alumínium toldóhüvelyt kiválasztani (nem része a garnitúrának).

A garnitúra tartalma:

- 1 db burkoló, vastagfalú zsugorcso, belső, hőre olvadó ragasztóval ①
- 4 db érszigetelő, közepesfalú zsugorcso, belső, hőre olvadó ragasztóval ②
- 1(2) db sajtolható, réz összekötő hüvely, a huzalárnyékolás összekötéséhez ③
- 1 tekerics párnázó szalag, térkitöltéshez ④
- 1 db csiszoló vászon ⑤

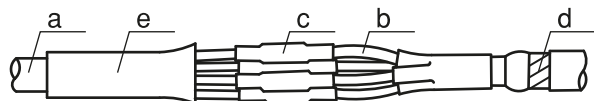

- a 4 vezetékes huzalárnyékolású kisfeszültségű kábel
- b kábelér
- c érszigetelő zsugorcso
- d huzalárnyékolás
- e burkoló köpenyszigetelő zsugorcso

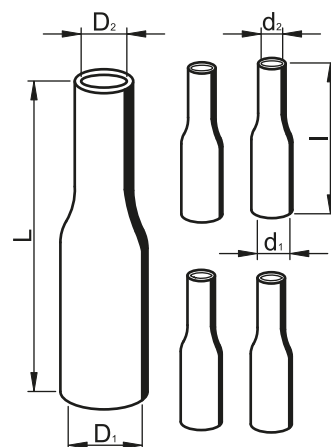

- d₁ – érszigetelő zsugorcso zsugorodás előtti belső átmérője
- d₂ – érszigetelő zsugorcso szabad zsugorítás utáni belső átmérője
- D₁ – köpenyszigetelő zsugorcso zsugorodás előtti belső átmérője
- D₂ – köpenyszigetelő zsugorcso szabad zsugorítás utáni belső átmérője

Szigeteletlen toldóhüvely



RELEVANT STANDARD
EN 60684

TÜV MEEI TEST DOCUMENTATION
V-10237

Kisfeszültségű kötőeszközök 0,6/1 kV-os szalagárnyékolású kábelekhez



Érszigetelő ill. köpenyszigetelő zsugorcsovek

TRACON	mm ²	d ₁ /d ₂ (mm)	l (mm)	X	D ₁ /D ₂ (mm)	L (mm)	X
ZSRSET-1DB	4 × 6 – 4 × 25	19/6	150	4	51/16	500	1
ZSRSET-2DB	4 × 35 – 4 × 120	30/8	200	4	85/25	1000	1
ZSRSET-3DB	4 × 150 – 4 × 240	50/16	300	4	130/36	1000	1

Árnyékolást helyreállító elemek

TRACON	Kábel keresztmetszet (mm ²)	Árnyékolás		Térkitöltés		Egyéb
		Földelő rugó	16 mm ² rézszövedék hossza	PVC párnázó szalag méretei (mm)	Tekerics szám	Csiszoló vászon méretei
ZSRSET-1DB	4 × 6 – 4 × 25	4 db TRF1	0.5 m	0.4 × 50 × 5000	1	600 mm × 25 mm
ZSRSET-2DB	4 × 35 – 4 × 120	4 db TRF2	0.7 m	0.4 × 50 × 5000	1	600 mm × 25 mm
ZSRSET-3DB	4 × 150 – 4 × 240	4 db TRF5	2 × 0.8 m	0.4 × 50 × 5000	1	800 mm × 25 mm

Az összekötni kívánt kábelek keresztmetszete alapján kell az érösszekötő réz ill. alumínium toldóhüvelyt kiválasztani.

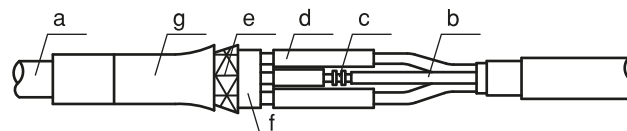

- a 4 vezetékes szalagárnyékolású kisfeszültségű kábel
- b kábelér
- c érösszekötő toldóhüvely
- d érszigetelő zsugorcso
- e szalagárnyékolás
- f földelő rugó
- g burkoló köpenyszigetelő zsugorcso

A garnitúra tartalma:

- 1 db burkoló, vastagfalú zsugorcso, belső, hőre olvadó ragasztóval ①
- 4 db érszigetelő, közepesfalú zsugorcso, belső, hőre olvadó ragasztóval ②
- 1 db rézszövedék szalag ③
- 4 db földelő rugó ④
- 1 tekerics párnázó szalag, térkitöltéshez ⑤
- 1 db csiszolóvászon ⑥

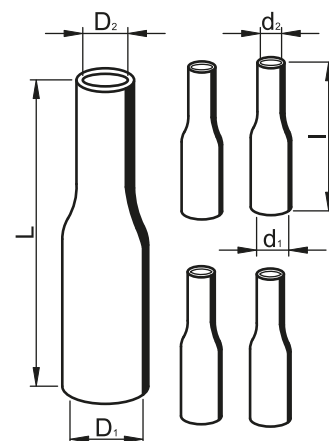

- d₁ – érszigetelő zsugorcso zsugorodás előtti belső átmérője
- d₂ – érszigetelő zsugorcso szabad zsugorítás utáni belső átmérője
- D₁ – köpenyszigetelő zsugorcso zsugorodás előtti belső átmérője
- D₂ – köpenyszigetelő zsugorcso szabad zsugorítás utáni belső átmérője

RELEVANT STANDARD
EN 60684

TÜV MEEI TEST DOCUMENTATION
V-10237

Kétágú végelzáró



TRACON	mm ²	D _{max} (mm)	D _{min} (mm)	d _{max} (mm)	d _{min} (mm)	S (mm)	S* (mm)	L (mm)	L* (mm)
V23012	2 × 4 – 2 × 35	30	9	15	4	1	2	83	88

D_{max}, d_{max} – zsugorodás előtti belső átmérőkD_{min}, d_{min} – szabad zsugorítás utáni belső átmérők

S – zsugorodás előtti falvastagság

S* – szabad zsugorítás utáni falvastagság

L – zsugorodás előtti teljes hossz

L* – szabad zsugorítás utáni teljes hossz

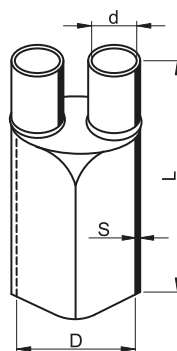

Háromágú végelzárók

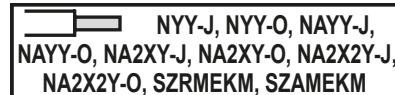

TRACON	mm ²	D _{max} (mm)	D _{min} (mm)	d _{max} (mm)	d _{min} (mm)	S (mm)	S* (mm)	L (mm)	L* (mm)
VE3259	3 × 2.5 – 3 × 10	25	9	9	3	2.5	1.8	50	70
VE33816	3 × 10 – 3 × 50	38	17	14	4,5	2,7	2,7	98	97
VE38036	3 × 70 – 3 × 240	80	38	35	11	2,8	3,5	185	195

D_{max}, d_{max} – zsugorodás előtti belső átmérőkD_{min}, d_{min} – szabad zsugorítás utáni belső átmérők

S – zsugorodás előtti falvastagság

S* – szabad zsugorítás utáni falvastagság

L – zsugorodás előtti teljes hossz

L* – szabad zsugorítás utáni teljes hossz

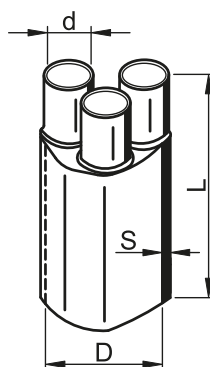
TÜV MEEI TEST DOCUMENTATION
K-08382RELEVANT STANDARD
EN 60684

Négyágú végelezárók

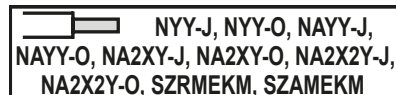

TRACON	mm ²	D _{max} (mm)	D _{min} (mm)	d _{max} (mm)	d _{min} (mm)	S (mm)	S* (mm)	L (mm)	L* (mm)
VE3512	4 × 6 – 4 × 25	35	14	13,5	4	1,5	2,2	80	95,3
VE3512C	4 × 6 – 4 × 25	42	15	13	5	1,6	2,5	95	103
VE4021	4 × 35 – 4 × 50	58	21	24,5	7	2,6	3,1	131	165
VE4021C	4 × 35 – 4 × 50	52	20	19	5,5	2,3	3,2	145	148
VE5527	4 × 70 – 4 × 120	70	24,5	24,5	7	2,9	5	150	185
VE5527C	4 × 70 – 4 × 120	74	25	27	8	2	3,4	180	177
VE8035	4 × 120 – 4 × 240	90	37	35	15	3	4	170	210
VE8035C	4 × 120 – 4 × 240	85	39	34	12,5	2,5	3,5	170	185
VE10045	4 × 150 – 4 × 300	102	47	38	12	3	4	185	195
VE12550	4 × 300	130	52	52	15	4	4	210	230

D_{max}, d_{max} – zsugorodás előtti belső átmérők
 D_{min}, d_{min} – szabad zsugorítás utáni belső átmérők
 S – zsugorodás előtti falvastagság
 S* – szabad zsugorítás utáni falvastagság

L – zsugorodás előtti teljes hossz
 L* – szabad zsugorítás utáni teljes hossz

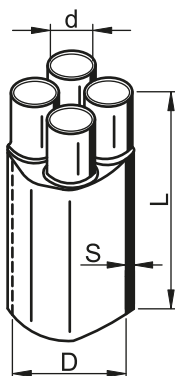

Hőlégfúvó

TRACON	U _n	[W]	°C	m	l/min.
HLF-02	230 V AC	1.000/2.000 W	350/600 °C	1450 g	300 / 500 l/min.

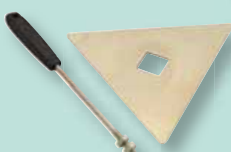

B/19

Ötágú végelzárók

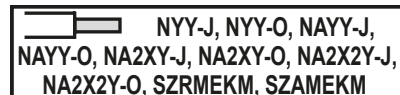

TRACON	mm ²	D _{max} (mm)	D _{min} (mm)	d _{max} (mm)	d _{min} (mm)	S (mm)	S* (mm)	L (mm)	L* (mm)
VE54019	5 × 16 – 5 × 35	40	19	13	4	2	2.5	105	98
VE55524	5 × 35 – 5 × 70	55	24	18	5	2	3.2	160	155
VE58033	5 × 70 – 5 × 120	80	33	16	8	2.1	3	155	180
VE510046	5 × 150 – 5 × 240	98	49	34.5	11	2.4	3.5	190	200

D_{max}, d_{max} – zsugorodás előtti belső átmérőkD_{min}, d_{min} – szabad zsugorítás utáni belső átmérők

S – zsugorodás előtti falvastagság

S* – szabad zsugorítás utáni falvastagság

L – zsugorodás előtti teljes hossz

L* – szabad zsugorítás utáni teljes hossz

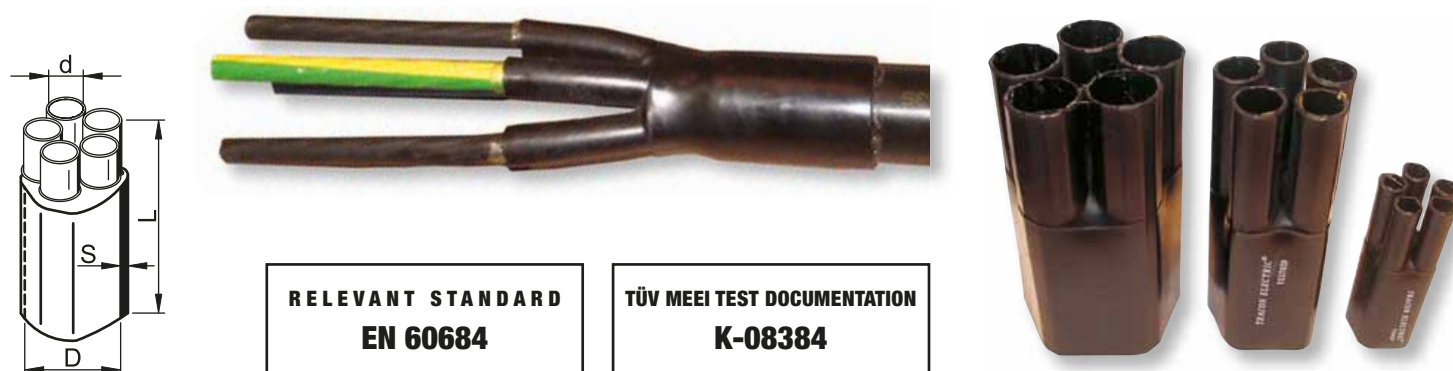

Szabadtéri végelzáró készletek 0,6/1 kV-os árnyékolatlan kábelekhez

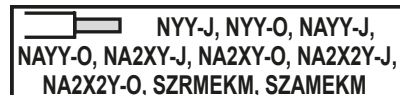

TRACON	Kábel keresztmetszet (mm ²)	Végelzáró (1)		Érszigetelő zsugorcső (2)		
		Típus	Darabszám	D ₁ /D ₂ (mm)	L (m)	Darabszám
VE3512-SZ	4 × 6 – 4 × 25	VE3512	1	12.7/6.4	3	1
VE4021-SZ	4 × 35 – 4 × 50	VE4021	1	19/9.5	4	1
VE5527-SZ	4 × 70 – 4 × 120	VE5527	1	25.4/12.7	5	1
VE8035-SZ	4 × 150 – 4 × 240	VE8035	1	38.1/19	8	1

A kábelsaru nem része a garnitúrának, azt a kábelek keresztmetszete alapján kell megválasztani.

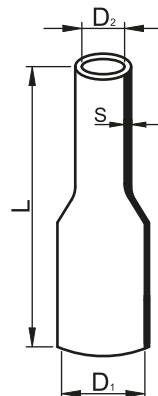
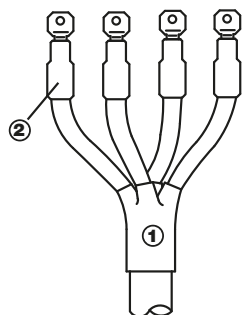

A garnitúra tartalma:

1 db négyágú végelzáró ①

1 tekerecs érszigetelő, UV-álló, vékonyfalú zsugorcső ②

A teljes érszigetelésre zsugorított UV-álló vékonyfalú zsugorcső kültéri használat esetén nedvesség ellen is véd.

Végelezáró készletek 0,6/1 kV-os 4-erű huzalárnyékolású kábelekhez



Érszigetelő ill. köpenyszigetelő zsugorcsovek

TRACON	Típus	Kábel keresztmetszet (mm ²)	Végelezáró (1)		Saru szigetelő zsugorcso			Teljes érszigetelő zsugorcso		
			Típus	Darab-szám	D ₁ /D ₂ (mm)	l (mm)	Darab-szám	D ₁ /D ₂ (mm)	L (m)	Darab-szám
ZSVRS-1B1	Beltéri	4 × 6 – 4 × 25	VE3512	1	19/6	50	4	–	–	–
ZSVRS-1K1	Kültéri	4 × 6 – 4 × 25	VE3512	1	19/6	50	4	12.7/6.4	2	1
ZSVRS-2B1	Beltéri	4 × 35 – 4 × 50	VE4021	1	30/8	50	4	–	–	–
ZSVRS-2K1	Kültéri	4 × 35 – 4 × 50	VE4021	1	30/8	50	4	19/9.5	3	1
ZSVRS-3B1	Beltéri	4 × 70 – 4 × 120	VE5527	1	40/12	80	4	–	–	–
ZSVRS-3K1	Kültéri	4 × 70 – 4 × 120	VE5527	1	40/12	80	4	25.4/12.7	4	1
ZSVRS-4B1	Beltéri	4 × 150 – 4 × 240	VE8035	1	50/16	100	4	–	–	–
ZSVRS-4K1	Kültéri	4 × 150 – 4 × 240	VE8035	1	50/16	100	4	38.1/19	8	1

Árnyékolást helyreállító elemek

TRACON	Kábel keresztmetszet (mm ²)	Térkitöltés		Egyéb
		Tömítő szalag típus	Hossz (m)	
ZSVRS-1B1	4 × 6 – 4 × 25	ZSSZOH1,5	1.5	600 mm × 25 mm
ZSVRS-1K1	4 × 6 – 4 × 25	ZSSZOH1,5	1.5	600 mm × 25 mm
ZSVRS-2B1	4 × 35 – 4 × 50	ZSSZOH1,5	1.5	600 mm × 25 mm
ZSVRS-2K1	4 × 35 – 4 × 50	ZSSZOH1,5	1.5	600 mm × 25 mm
ZSVRS-3B1	4 × 70 – 4 × 120	ZSSZOH1,5	1.5	600 mm × 25 mm
ZSVRS-3K1	4 × 70 – 4 × 120	ZSSZOH1,5	1.5	600 mm × 25 mm
ZSVRS-4B1	4 × 150 – 4 × 240	ZSSZOH1,5	1.5	800 mm × 25 mm
ZSVRS-4K1	4 × 150 – 4 × 240	ZSSZOH1,5	1.5	800 mm × 25 mm

A kábelerek keresztmetszete alapján kell a kábelsarukat megválasztani (nem részei a garnitúrának).



D₁, d₁ – zsugorodás előtti belső átmérők
D₂, d₂ – szabad zsugorítás utáni belső átmérők

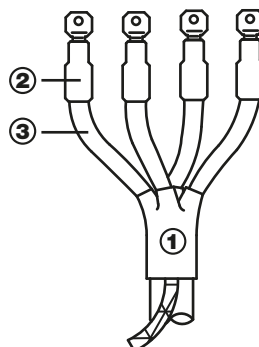
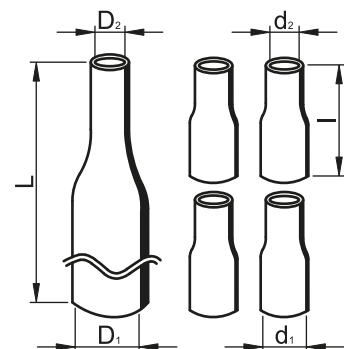

A garnitúra tartalma:

- 1 db négyágú elágazó idom ①
- 4 db középesfalú, ragasztóval ellátott sarufelület szigetelő zsugorcso ②
- 1 db UV álló, vékonyfalú teljes érszigetelő zsugorcso (csak kültéri típusokhoz) ③
- 1 db csiszolóvászon ④
- 1 db ZSSZOH1,5 típusú tömítő szalag ⑤

RELEVANT STANDARD
EN 60684

TÜV MEEI TEST DOCUMENTATION
V-10238

Végelzáró készlet 0,6/1 kV-os 4-erű szalagárnyékolású kábelekhez



Érszigetelő ill. köpenyszigetelő zsugorcsockok

TRACON	Típus	Kábel keresztmetszet (mm ²)	Végelzáró (1)		Saru szigetelő zsugorcsock			Teljes érszigetelő zsugorcsock		
			Típus	Darab-szám	D ₁ /D ₂ (mm)	l (mm)	Darab-szám	D ₁ /D ₂ (mm)	L (m)	Darab-szám
ZSVRS-1B2	Beltéri	4 × 6 – 4 × 25	VE3512	1	19/6	50	4	–	–	–
ZSVRS-1K2	Kültéri	4 × 6 – 4 × 25	VE3512	1	19/6	50	4	12.7/6.4	2	1
ZSVRS-2B2	Beltéri	4 × 35 – 4 × 50	VE4021	1	30/8	50	4	–	–	–
ZSVRS-2K2	Kültéri	4 × 35 – 4 × 50	VE4021	1	30/8	50	4	19/9.5	3	1
ZSVRS-3B2	Beltéri	4 × 70 – 4 × 120	VE5527	1	40/12	80	4	–	–	–
ZSVRS-3K2	Kültéri	4 × 70 – 4 × 120	VE5527	1	40/12	80	4	25.4/12.7	4	1
ZSVRS-4B2	Beltéri	4 × 150 – 4 × 240	VE8035	1	50/16	100	4	–	–	–
ZSVRS-4K2	Kültéri	4 × 150 – 4 × 240	VE8035	1	50/16	100	4	38.1/19	8	1

Árnyékolást helyreállító elemek

TRACON	Kábel keresztmetszet (mm ²)	Árnyékolás		Térkitöltés		Egyéb
		Földelő rugó (mm ²)	Óozott rézszövetek szalag	Tömítő szalag típus	Hossz (m)	
ZSVRS-1B2	4 × 6 – 4 × 25	2 db TRF1	1 db 0.7 m	ZSSZOH1,5	1	600 mm × 25 mm
ZSVRS-1K2	4 × 6 – 4 × 25	2 db TRF1	1 db 0.7 m	ZSSZOH1,5	1	600 mm × 25 mm
ZSVRS-2B2	4 × 35 – 4 × 50	2 db TRF2	1 db 0.7 m	ZSSZOH1,5	1	600 mm × 25 mm
ZSVRS-2K2	4 × 35 – 4 × 50	2 db TRF2	1 db 0.7 m	ZSSZOH1,5	1	600 mm × 25 mm
ZSVRS-3B2	4 × 70 – 4 × 120	2 db TRF4	1 db 0.7 m	ZSSZOH1,5	1	600 mm × 25 mm
ZSVRS-3K2	4 × 70 – 4 × 120	2 db TRF4	1 db 0.7 m	ZSSZOH1,5	1	600 mm × 25 mm
ZSVRS-4B2	4 × 150 – 4 × 240	2 db TRF5	2 db 0.7 m	ZSSZOH1,5	1	800 mm × 25 mm
ZSVRS-4K2	4 × 150 – 4 × 240	2 db TRF5	2 db 0.7 m	ZSSZOH1,5	1	800 mm × 25 mm

A kábelerek keresztmetszete alapján kell a kábelsarukat megválasztani (nem részei a garnitúrának).

A garnitúra tartalma:

- 1 db négyágú elágazó idom ①
- 4 db közepesfalú, ragasztóval ellátott sarufelület szigetelő zsugorcsock ②
- 1 db UV álló, vékonyfalú teljes érszigetelő zsugorcsock (csak kültéri típusokhoz) ③
- 1 db csiszolóvászson ④
- 1 db ZSSZOH1,5 típusú tömítő szalag ⑤
- 1 db óozott rézszövetek szalag ⑥
- 2 db földelő rugó ⑦

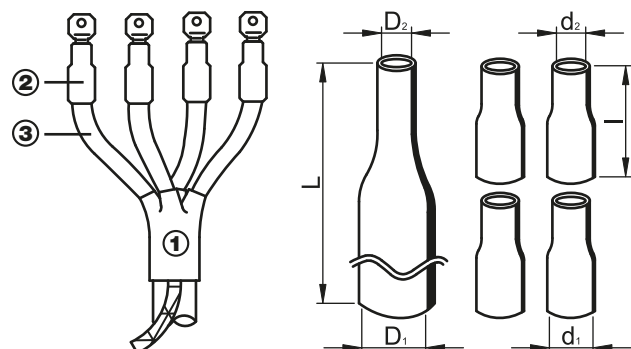



RELEVANT STANDARD
EN 60684

TÜV MEEI TEST DOCUMENTATION
V-10238

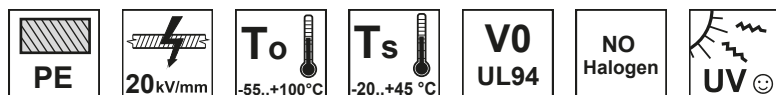

Kiöntőgyantás egyenes kötészkezetek



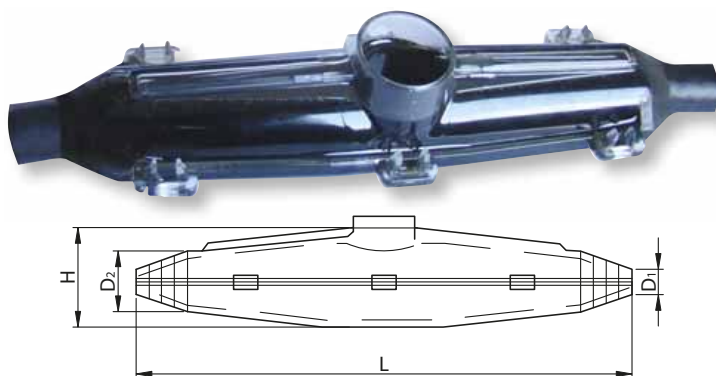

TRACON	 mm ²	L (mm)	H (mm)	D ₁ (mm)	D ₂ (mm)
KET-1,5-10	4 × 1.5 – 4 × 10	210	36	8	26
KET-6-25	4 × 6 – 4 × 35	260	47	16	34
KET-16-50	4 × 25 – 4 × 70	360	55	21	43
KET-50-95	4 × 50 – 4 × 120	400	70	26	48
KET-70-150	4 × 70 – 4 × 150	530	100	35	63
KET-150-300	4 × 150 – 4 × 300	700	125	47	81



A készlet tartalma:

- Két részből álló (PET) műanyag ház;
- Kétkomponensű öntőgyanta elválasztó műanyag elemmel, 5 rétegből laminált alumíniumtasakban;
- PVC szalag, csiszolóvászon;
- PE kesztyű, dielektromos törőlkendő;
- Használati útmutató.

Kiválasztási segédlet a kötendő kábelerek száma és keresztmetszete szerint

TRACON	KET-1,5-10	KET-6-25	KET-16-50	KET-50-95	KET-70-150	KET-150-300
 3× (mm ²)	3 × 4 3 × 6 3 × 10 3 × 16	3 × 10 3 × 16 3 × 25 3 × 35	3 × 25 3 × 35 3 × 50 3 × 70	3 × 50 3 × 70 3 × 95 3 × 120	3 × 120 3 × 150 3 × 185	3 × 240
 4× (mm ²)	4 × 1.5 4 × 2.5 4 × 4 4 × 6 4 × 10	4 × 6 4 × 10 4 × 16 4 × 25 4 × 35	4 × 25 4 × 35 4 × 50 4 × 70	4 × 50 4 × 70 4 × 95 4 × 120 4 × 150	4 × 70 4 × 95 4 × 120 4 × 150	4 × 150 4 × 185 4 × 240 4 × 300
 5× (mm ²)	5 × 1.5 5 × 2.5 5 × 4 5 × 6 5 × 10	5 × 4 5 × 6 5 × 10 5 × 16 5 × 25	5 × 16 5 × 25 5 × 35 5 × 50	5 × 25 5 × 35 5 × 50	5 × 50	–



Kiöntőgyantás „Y” kötészkezetek



Piktogramok

D/O

TRACON	(mm ²)	(mm ²)	D ₁ (mm)	D ₂ (mm)	L (mm)	H (mm)
KYT-2,5	4 × 1.5 – 2.5	4 × 1.5	11	20	150	50
KYT-4-10	4 × 4 – 10	4 × 4	6	21	175	60
KYT-6-25	4 × 6 – 25	4 × 16	9	24	225	70

A készlet tartalma:

- Két részből álló (PET) műanyag ház;
- Kétkomponensű öntőgyanta elválasztó műanyag elemmel, 5 rétegből laminált alumíniumtasakban;
- PVC szalag;
- Dielektromos törőlkendő;
- Csiszolóvászson;
- PE kesztyű;
- Használati útmutató.

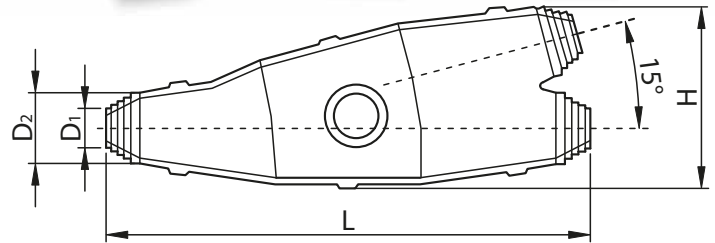

RELEVANT STANDARD
EN 50393



Kétkomponensű kiöntőgyanta

TRACON	ml	g		To		
KGY-80	80 ml	120 g	24 / 3 / 1 hour (5 / 23 / 35 °C)	5...60 °C	360 mg	20 kV
KGY-150	150 ml	197 g	24 / 3 / 1 hour (5 / 23 / 35 °C)	5...60 °C	400 mg	20 kV
KGY-464	464 ml	547 g	24 / 3 / 1 hour (5 / 23 / 35 °C)	5...60 °C	400 mg	20 kV

A gyanta a minőségét vegyítés nélkül a gyártástól számított 48 hónapig őrzi meg 15 és 35 °C közötti tárolási hőmérsékleten.

A tasakon található elválasztó műanyag elem eltávolítása után a gyanta két komponensét összekeverve egy könnyen önthető, de pár perc alatt megszilárduló anyag jön létre, mely bármilyen villamos kötés elektromos és víz behatolása elleni szigetelését biztosítja 1 kV névleges feszültség-szintig.

A gyanta színe: fekete.



Csavaros kötőelemek kábel-leágazások készítéséhez

Az YCSK kötőelem család változatait speciálisan kábel-leágazások kivelezéséhez tervezték. A vágott menetes szárba a szorítóanya levétele és a vezeték szigetelésének eltávolítása után a gerincvezeték megszakítás nélkül becsúsztható, főleg legalább egy azonos keresztmetszetű, vagy több kisebb keresztmetszetű leágazó kábel vezetője helyezhető a rendelkezésre álló hely függvényében.



A/13

Záró sapkák



TRACON	4× (mm ²)	3× (mm ²)	1× (mm ²)	D _{max} (mm)	D _{min} (mm)	L (mm)	L* (mm)
VES124	1 kV: 4×1,5	–	–	11.5	4	38	39
VES208	1 kV: 4×2,5 – 4×25	–	–	26	8	75	69
VES3515	1 kV: 4×35 – 4×70	10-30 kV: 3×50 – 3×120	10-30 kV: 1×50 – 1×120	35	15	110	106
VES5524	1 kV: 4×95 – 4×185	10-30 kV: 3×150 – 3×400	10-30 kV: 1×150 – 1×400	55	24	110	110
VES7533	1 kV: 4×240 – 4×300	20-35 kV: 3×185 – 3×300	20-35 kV: 1×185 – 1×300	74	35	130	120
VES10058	–	120-132 kV: 3×185 – 3×300	120-132 kV: 1×185 – 1×300	100	50	160	135



D_{max} – zsugorodás előtti belső átmérő
 D_{min} – szabad zsugorítás utáni belső átmérő
 L – zsugorodás előtti teljes hossz
 L* – szabad zsugorítás utáni teljes hossz

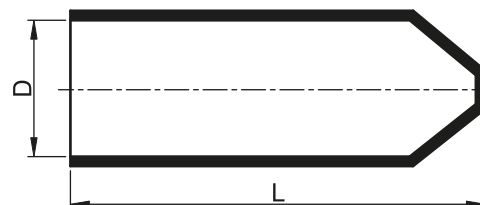

Cipzárás zsugor javító készletek



TRACON	mm ²	D _{max} (mm)	D _{min} (mm)	S (mm)	S* (mm)	L (mm)
ZSJR50/05	4 × 6 – 4 × 25	50	15	1.1	3.3	500
ZSJR50/1	4 × 6 – 4 × 25	50	15	1.1	3.3	1000
ZSJR50/15	4 × 6 – 4 × 25	50	15	1.1	3.3	1500
ZSJR75/05	4 × 35 – 4 × 120	75	22	1.2	3.5	500
ZSJR75/1	4 × 35 – 4 × 120	75	22	1.2	3.5	1000
ZSJR75/22	4 × 35 – 4 × 120	75	22	1.2	3.5	1500
ZSJR146/05	4 × 150 – 4 × 240	146	38	1.2	3.5	500
ZSJR146/1	4 × 150 – 4 × 240	146	38	1.2	3.5	1000
ZSJR146/38	4 × 150 – 4 × 240	146	38	1.2	3.5	1500
ZSJR180/05	4 × 185 – 4 × 300	180	50	1.5	3.2	500
ZSJR180/1	4 × 185 – 4 × 300	180	50	1.5	3.2	1000
ZSJR180/15	4 × 185 – 4 × 300	180	50	1.5	3.2	1500



S – zsugorodás előtti falvastagság
 S* – szabad zsugorítás utáni falvastagság



RELEVANT STANDARD
EN 60684

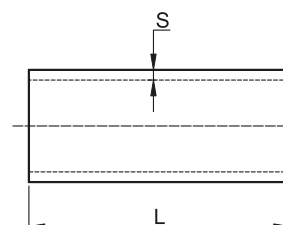

Hidegzsugor cső



TRACON	D1 (mm)	D2 (mm)	S (mm)	L (mm)
HZS28-100	28	10	2,5	100
HZS36-100	36	17	2,5	100
HZS54-100	54	27	2,5	100
HZS92-100	92	32	3,0	100
HZS105-100	105	36	3,0	100
HZS28-200	28	10	2,5	200
HZS36-200	36	17	2,5	200
HZS54-200	54	27	2,5	200
HZS92-200	92	32	3,0	200
HZS105-200	105	36	3,0	200
HZS28-400	28	10	2,5	400
HZS36-400	36	17	2,5	400
HZS54-400	54	27	2,5	400
HZS92-400	92	32	3,0	400
HZS105-400	105	36	3,0	400

Szilikon alapú hidegzsugor szigetelőcsövek villamos csatlakozások szigetelésére. A technológiának köszönhetően flexibilis kötéslezárást biztosít, a zsugorításához speciális szerszámra, lángra nincs szükség.

A támasztóspirál kitékerésével a cső az előkészített kábelre zsugorodik, állandó szorítóerejéből adódóan kiváló vízzárást is biztosít.

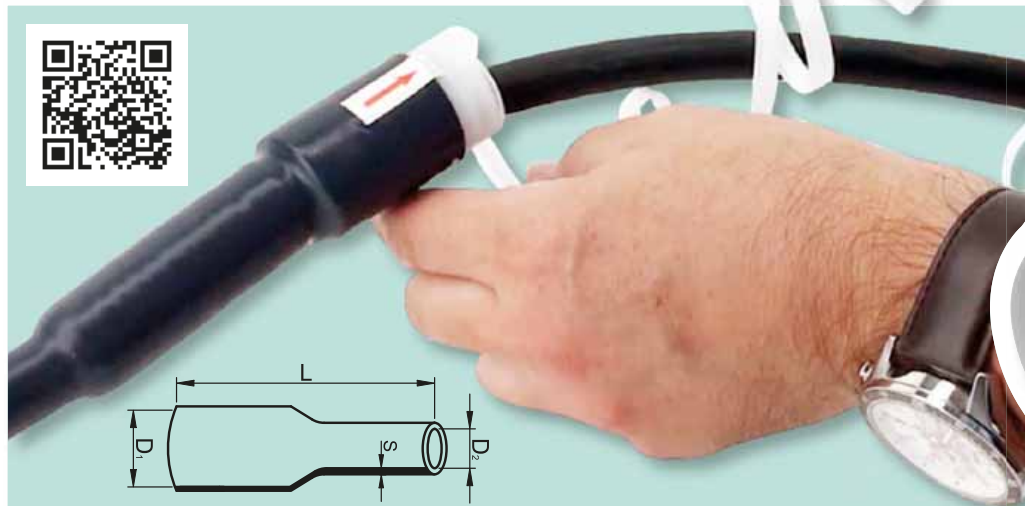

ZSSZR5 Rézharisnya szalag



Végelzárók és kötések kábeli árnyékolásának villamos szempontból történő helyreállítására alkalmasak. Egyaránt használhatóak kis- és középfeszültségű szerelvényeknél.

Méret: 5 m × 30 mm × 0,4 mm

Vizsgálat	Adatok	Tesztmódszerek
Nyúlás	min. 70%	ASTM D412
Szakító szilárdság	min. 35 N/10 mm ²	ASTM D412
Térfogat ellenállás	min. 0.3 Ωcm	ASTM D257

ZSSZOH1,5 Tömítő szalag

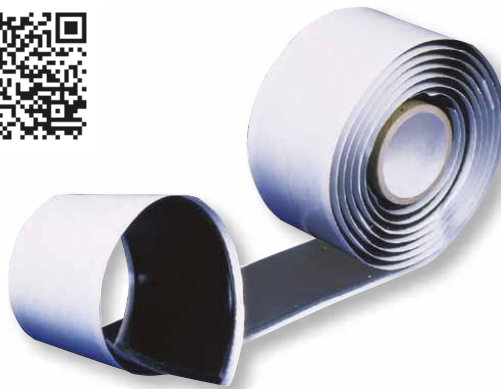

Középfeszültségű végelzárók és kötéskészletek komponense. A szigetelések fokozott nedvesség elleni védelmére szolgál.

Méret: 1,5 m × 38 mm × 3 mm
Szín: fekete

Vizsgálat	Adatok	Tesztmódszerek
Nyúlás	min. 1000%	ASTM D412
Szakító szilárdság	min. 3 N/10 mm ²	ASTM D412
Térfogat ellenállás	min. 10 ¹⁴ Ωcm	ASTM D257
Átütési szilárdság	min. 3 kV/mm	ASTM D149

ZSSZVM-1 Térkitöltő massa szalag



Középfeszültségű végelzárók és kötéskészletek komponense. A közepfeszültségű kábelek egyes rétegeinek kötésénél és végelzárásánál térkitöltésre és potenciálváltakozásra használható.

Méret: 1,5 m × 25 mm × 0,8 mm
Szín: vörös

Vizsgálat	Adatok	Tesztmódszerek
Sűrűség	1.3 g/cm ³	UNI 7092
Átütési szilárdság	min. 15 kV/mm	UNI 4291
Térfogat ellenállás	min. 1 × 10 ¹² Ωcm	UNI 4288

Földelő rugó



Kis- valamint közepfeszültségű kötés- és végelzáró szerelvények árnyékolást helyreállító ózozott réz-szövedékének a kábelek szalagárnyékoláshoz való rögzítésére használható.

TRACON	D _{min} (mm)	D _{max} (mm)	Vastagság (mm)
TRF0	12	19	0.2
TRF1	17	22	0.2
TRF2	19	29	0.2
TRF3	25	37	0.3
TRF4	31	50	0.3
TRF5	44	70	0.3
TRF6	58	94	0.4
TRF7	60	130	0.4

D_{min}: biztonságosan megszorítható legkisebb átmérő

LSJ

LED UTCAI VILÁGÍTÁS

TRACON
.....**ELECTRIC®**



E/16-E/18



FIGYELEM!































**Megjelent különálló
Világítástechnika
katalógusunk!**

- 110 termékcsalád
- 800 termék
- Referenciák
- LED újdonságok
- QR kód minden termékénél
- Fénytechnikai laboratórium
- Világítástervezés
- Ulbricht-gömb





































**Keresse üzletkötőinknél
és a szakkereskedésekben!**



Táblázat fejlécek piktogramjai

 Hagyományos izzó kiváltás	 Kompakt fénycső kiváltás	 Fémhalogén kiváltás	 Halogén izzó kiváltás
 Fénycső kiváltás	 Kivágási méret (mm)	 Méretek (L x W x H), (D x L)	 Ajánlott oszlop magasság és átmérő (mm)
 Foglalat típusa	 Töltési idő	 Hangjelző	IP.. Védettségi fokozat
 Akkumulátor teljesítménye (Ah)	 Akkumulátor feszültsége (V)	 Akkumulátor típusa	η% Hatásfok
 Buratartó zárok száma (db)	 Sugárzási szög (°)	 Érzékelési szög	 Szín
In Névleges áram (A)	Un Névleges feszültség (V)	 Billenthető lámpatest	 Oldalsó védőérintkezős
 Fényáram (lumen)	 Színhőmérséklet (Kelvin)	 Névleges teljesítmény	 Energiahatékonysági osztály
 Kapcsolóval	 Átídalási idő (h)	 Megvilágítás (lux)	 LED-ek száma (db)
 Primer áram	 Maximális szekunder áram	 Szekunder feszültség	P_{max} Maximális terhelhetőség

Műszaki adatok piktogramjai

 Beltéri világításra alkalmas lámpatest	 Beltéri és kültéri világításra alkalmas lámpatest	 Kültéri világításra alkalmas lámpatest	 50/60 Hz Névleges frekvencia
 Mennezetre szerelhető lámpatest	 Oldalfalra szerelhető lámpatest	 Oldalfalra és mennyezetre szerelhető lámpatest	 Álmennyezetbe süllyeszthető lámpatest
 Nem alkalmazható fényerőszabályzóval	 Alkalmazható fényerőszabályzóval	 Élettartam 50.000	 ON-OFF Kapcsolások száma >30.000
 I. érintésvédelmi osztályú lámpatest	 II. érintésvédelmi osztályú lámpatest	 III. érintésvédelmi osztályú lámpatest	 Távirányító
 Beköthető vezeték keresztmetszet 2 x 1,5	 Beköthető vezeték 3 x 1,5mm² 30 cm	 Nem cserélhető a fényforrás	 Színvisszaadási index ≥80 Ra
90-265 V AC Névleges feszültség (V)	IP 65 Védettségi fokozat	 Ütésállóság IK08	 Az alkalmazható legnagyobb fényforrás átmérője 60 mm
 Biztonsági transzformátor	PFC Aktív teljesítménytényező szabályzás	 Elektronikus előtét EVG	 Magnetikus előtét VVG
 Vágható	 3 lépcsős fényerőszabályzás 12-50-100 %	 Káprázás UGR <19	 Felfutási idő T_{up} <1s
 Napelem	 Környezeti hőmérséklet T_a -5...+40 °C	 Beállítási időtartomány 10s-12min	 Sugárzási szög 250°
3-2.000 lux Megvilágítás (lux)	 Érzékelő	 Érzékelési szög 180°	 Mozgási sebesség 0,6...1,5m/s



Kültéri LED csarnokvilágítók, LHBP és LHBU széria **13**



LED csarnokvilágító integrált meghajtóval **14**



LED csarnokvilágító, fényerő-szabályozható **15**



Sorolható védett LED ipari világítótest **15**



LED utcai világítóttest, LSJA és LSJB széria (síkfüveggel) **16**



LED utcai világítóttest, LSJR széria **17**



LED utcai világítóttest, LSJK széria **18**



Kiegészítők **18**



Napelemes utcai LED világítóttest mozgásérzékelővel **19**



LED fényvetők, RSMDB széria **20**



LED fényvetők, R-SMDP széria **21**



LED fényvető, szimmetrikus, RHIS széria **22**



LED fényvetők, RSMDL széria **23**



Hordozható / szerelő LED fényvetők **26**



Hordozható LED fényvető - profi **27**



Napelemes LED fényvető mozgásérzékelővel **28**



Napelemes LED fali világítóttest mozgásérzékelővel **29**



LED biciklilámpák **30**



Éjszakai fények **30**



LED fejlámpák **31**



Autós vészjelző lámpa **31**



LED kézi lámpák **32**



LED kézi lámpák **33**



Kerek, beépíthető LED panel **34**



Négyzet alakú, beépíthető LED panel **34**



Inverteres vészvilágító kiegészítő egység LED panelekhez **35**



Kerek, beépíthető LED panel fokozott védelemmel **35**



Kerek, beépíthető LED panel **36**



Négyzet alakú, beépíthető LED panel SAMSUNG chippel **36**



Védett, beépíthető LED mélysugárzó, kerek **37**



Védett, beépíthető LED mélysugárzó, négyzetes **37**



Kompakt beépíthető LED mélysugárzó **38**



LED mélysugárzó változtatható színhőmérséklettel **38**



Süllyesztett lámpatestek spot fényforrásokhoz **39**

...és további
2 oldal



LED mélysugárzó, forgatható 40



LED panel, LPM széria 41



LED panel, LPH széria 42



Meghajtó LPM és LPH panelekhez 42



Szerelőkeret LED panelekhez 43

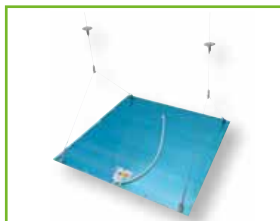

Függesztő készlet LED panelekhez 43



Fényerő-szabályozható meghajtó 43



Rögzítő fül LED panelek súllyesztett szereléséhez 43



Kerek LED falilámpát, LED-DLF széria 44



Négyzet alakú LED falilámpát, LED-DLNF széria 44



Kerek LED falilámpát, LED-DLF széria, SAMSUNG chipel 45



Négyzet alakú LED falilámpát, LED-DLNF széria 45



Kerek LED falilámpát, MFDS széria 46



Kerek LED falilámpát, MFU széria 46



Fényerő-szabályozható LED falilámpát 47



Fényerő-szabályozható LED falilámpát, függeszthető 47



Kerek LED falilámpát állítható színhőmérséklettel 48



UFO fényerő-szabályozható mennyezeti lámpát (3000/4000/5700K) 48



Fali lámpát, ívelt forma 49



LED falilámpát, MF széria (csillagfény effekttel) 50



LED falilámpát, MFS széria 50



Design lámpa SKY széria (csillagfény effekttel) 51



LED falilámpát, MFR széria (csillagfény effekttel) vezérelhető 51



Műanyag búrás falon kívüli LED lámpát fokozott védelemmel 52



LED falilámpát, EVA széria 53



LED falilámpát, LFEK széria 54



LED falilámpát, MFM széria (mozgásérzékelővel) 54



Üvegburás fali- és mennyezeti lámpák (UFO lámpák) 55



Kézzel nyitható védett fali lámpát („hajólámpa”) 55



Védett, műanyag ház as LED hajólámpa 56



LED hajólámpa, műanyag ház 56



Védett LED ipari lámpát 57



Védett LED ipari lámpát 58



Védett LED ipari lámpát por és páramentes 59



Védett lámpát LED világító csövekhez 60



Inverteres vészvilágító kiegészítő egységek 60



Védett fénycsőves lámpatestek 61



Elektronikus előtétetek T8-as fénycsővel szerelt lámpatestekhez 61



LED kijáratjelző világítótestek 62



LED-es vészvilágító lámpatest, cserélhető lencsével 62



Vészvilágítók 63



Kiegészítők 63



Védett LED bútorvilágítók, TLFLD sorozat 64



LED bútorvilágítók, TLLED sorozat 64



LED bútorvilágító, műanyag ház 65



LED tükörvilágító lámpa 66



Nyitott lámpatest T8 LED világító csövekhez 67



Normál szerelőlámpák 67



LED asztali világítótestek 68



LED süllyesztett lépcsővilágító, LVS sorozat 70



LED földbe süllyeszthető világítótestek 70



Kültéri LED fali világítótestek, GARC sorozat 71



Kültéri LED fali világítótestek, GLOO sorozat 71



Kültéri világítótestek 72



Alkonykapcsolók 74



PRS.. Jelenlét-érzékelő 75



Speciális mozgásérzékelők 75



Radaros (mikrohullámú) mozgásérzékelők 76



Beltéri infravörös mozgásérzékelők 77



Védett infravörös mozgásérzékelők 78



Fém ház, védett ELG LED meghajtók 80



Dugaszolható tápegységek 81



Sinre pattintható tápegységek 81



Fém ház LED meghajtók 82



Műanyag ház, védett LED meghajtók 83



Scharfer LED meghajtó 83



Szerelvénydobozba építhető fényerő-szabályzó modulok 84



Vezeték nélküli vezérlőegység világítási áramkörökhez 84



DIN sinre szerelhető fényerő-szabályzó modulok 85



Kompensátor 85

Referencia

Kérjük tekintse meg az alábbi bel- és kültéri referencia projekteket, melyeket partnereink Tracon termékek felhasználásával valósítottak meg.

Flesch Károly Művelődési ház – Mosonmagyaróvár, Magyarország
 Közvilágítás – Mosonmagyaróvár, Magyarország
 Hangár – Gyúró, Magyarország
 Szemléletformáló és Újrahasználati Központ – Budapest, Magyarország
 Lakihegyi Akácliget Tagóvoda – Szigetszentmiklós, Magyarország
 Művelődési ház – Kisvárd, Magyarország
 Raben Trans European – Dunaharaszti, Magyarország
 BHG táncstúdió – Budapest, Magyarország
 Kápolnásnyék, Fő tér, kerékpárút, Magyarország
 Gémeskút étterem, Sukoró, Magyarország
 Gallicoop, Szarvas Ipartelepi út 531/1, Magyarország
 Pioneer, Szarvas, Magyarország
 Halászi-Arak közvilágítás, Magyarország
 Székesfehérvár, Tollascsarnok, Magyarország
 Dr Papp László Sportcsarnok – Szentes, Magyarország

ML Produktion s.r.o., Knill Grupe – Myjava, Szlovákia
 Szlovák Tudományos Akadémia – Pozsony, Szlovákia
 Új Terasz Lakásegység – Kassa, Szlovákia
 Meddő teljesítmény szabályozó elosztóállomás – Nižný Hrušov, Szlovákia
 Magnet Marelli – Kassa, Szlovákia
 Bevásárló- És Szolgáltató Központ – Surány, Szlovákia
 Gukom Kft. – Gúta, Szlovákia
 Szálloda – Tatranská Lesná, Szlovákia
 Szlovák Rádió És Televízió – Pozsony, Szlovákia
 Szakközépiskola Iváni Út – Pozsony, Szlovákia
 Slovarm Spa -Myjava, Szlovákia
 Thermoplastik – Poriadie, Szlovákia
 Szlovák Államvasutak – Poprád, Szlovákia
 Vertiv Csarnok – Vágújhely, Szlovákia

Mechanikai műhely – Pivka, Szlovénia
 Üzleti és irodai helyiségek – Ormož, Szlovénia
 Raktárvilágítás – Ormož, Szlovénia
 Céllövészeti Sport Klub COAL Petesháza, Szlovénia
 Csarnokvilágítás – Ravne Na Koroškem, Szlovénia
 Gyártócsarnok, Iroda, Raktár – Sežana, Szlovénia
 Műszaki Bolt – Sežana, Szlovénia
 Vitolina Homes – Prevalje, Szlovénia
 Festék- és lakkbolt Morgana d. o. o. - Gornja Radgona, Szlovénia



Prestige étterem – Lazarevac, Szerbia
 Somboled tejgyár – Sombor, Szerbia

Birkózó terem – Székelyudvarhely, Románia

AEM – Temesvár, Románia

Alusystem – Temesvár, Románia

Surub trade csarnok – Marosvásárhely, Románia

Sportcentrum, tenispálya, műfüves focipálya és squash pálya – Čavle, Horvátország

BRAČ sziget – Apartmanházak – Sutivan, Horvátország

Molo Longo – személyforgalmú komp kikötő – Rijeka, Horvátország

Közvilágítás – Bjelovar, Horvátország

Közvilágítás – Vinkovici, Horvátország

Városi strandfürdő – Đakovo Gradski bazeni, Horvátország

Utcai Világítás – Buzet, Horvátország

Cib Commerce – Buzet, Horvátország

Cimos – Buzet, Horvátország

Color Emalj D.O.O. – Pozega, Horvátország

Sportpálya Világítás – Donja Rača, Horvátország

Climolux Csarnok – Vrbovec, Horvátország

Hotel Jupiter – Split, Horvátország

Utcai Világítás – Lupoglav, Horvátország

Marinexpert – Dugopolje, Horvátország

Pekara Babic – Split, Horvátország

Iskola – Pula, Horvátország

Óvoda – Rudine, Horvátország

Autoline Autómosó – Split, Horvátország

Tehnofilter Csarnok – Beli Manastir, Horvátország

Vinkoprom – Vinkovci, Horvátország

Utcai Világítás – Vinkovci, Horvátország

NK VARTEKS futballpálya – Varaždin-Hraščica, Horvátország

Nyomda – Bielsko-Biala, Lengyelország

Fafeldolgozó üzem Tartak FENIKS – Miasteczko Śląskie, Lengyelország

Sziléziai Kertészeti és Méhészeti Szövetkezet – Ruda Śląska, Lengyelország

Hulladékfeldolgozó Központ – Katowice, Lengyelország

Üvegkohó Kültéri Világítás – Katowice, Lengyelország

Aquard Sp. Z O.O Kültéri Világítás – Katowice, Lengyelország



Fénytechnikai laboratórium

A TRACON Budapest Kft. Fénytechnikai Laboratóriumával teljes körűen képes biztosítani az általa forgalmazott fényforrások minőségét. A 2008-ban létesített Fénytechnikai Laboratórium segítségével átfogóan, mintavételezéssel vizsgáljuk az általunk forgalomba hozott összes fényforrás műszaki paramétereit.

Ulbricht-gömb:

A gömb segítségével egy adott fényforrás teljes Foto-spektrum analízisét el tudjuk végezni, így olyan információkat nyerünk, mint:

- a fényforrás fényárama (lumen)
- a kibocsátott fény hőmérséklete (Kelvin)
- fényáram hasznosítás (hatásfok –lumen/Watt)
- a fényforrás felvett teljesítménye és áramerőssége
- színvisszaadási indexe
- a fényforrás működési hőmérséklete

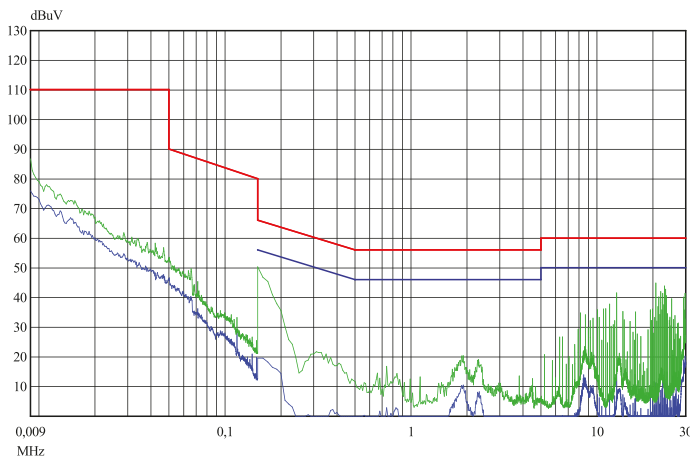
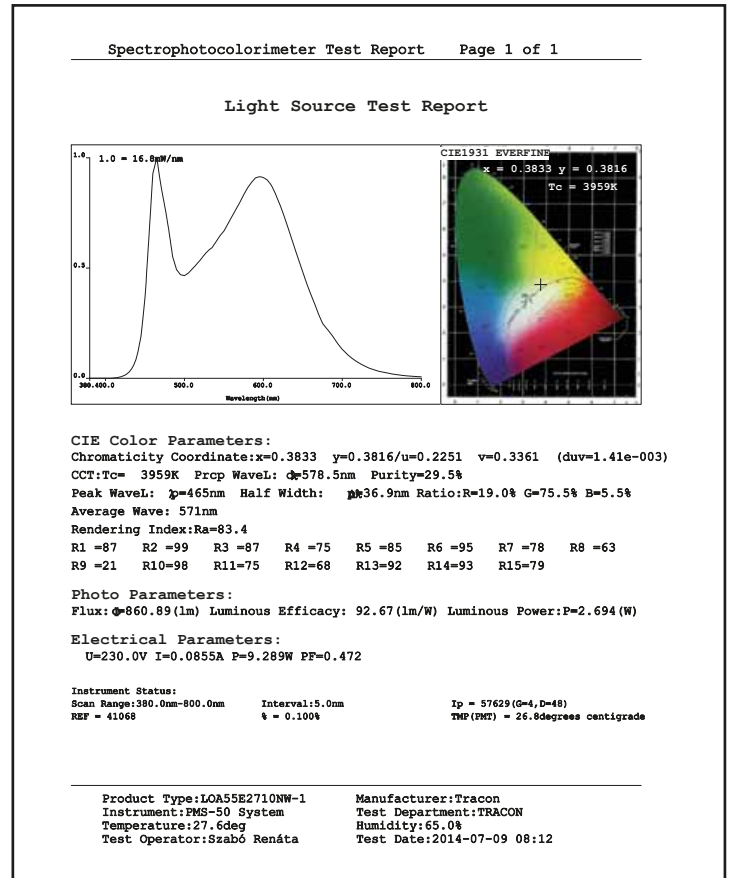

2021 májusától új energiacímkezési rendelet (2019/2015/EU) lép életbe a fényforrások tekintetében. Az új rendelet alapján minden fényforrásra meg kell adni a villogás (PstLM) és a stroboszkóp hatás (SvM) értékeit. A fénytechnikai laboratóriumunk új "Labflicker" nevű mérőműszere segítségével a fényforrásinkra vonatkozóan egy számítógépes program által komplett mérési jegyzőkönyvben kaphatjuk meg ezeket a fontos paramétereket.

EMC vizsgálóberendezés:

Az EMC vizsgálat során a fényforrás zavar-kapocs feszültségét vizsgáljuk. Az EN-55015-ös szabvány szerinti vizsgálat során képesek vagyunk kiszűrni az olyan, a fényforrás által keltett, a hálózatba visszavezetett nagyfrekvenciás zavarokat, amelyek zavarhatják az erre a frekvenciasávra érzékeny berendezéseket (rádió, TV). A műszer a 0,09-30 MHz-es tartományt vizsgálja.

Fényforrás-járató:

A 30 db fényforrás élettartam-vizsgálatára alkalmas állvány és a hozzá csatlakoztatott műszer nem csak előre programozott időközönként kapcsolja ki-be a fényforrásokat, hanem közben elemzést is végez azok áramfelvételéről. Így a szabványban előírt paraméterek szerinti élettartam vizsgálatokat is el tudjuk végezni.



OLVASSA BE A KÓDOT!

- Nézze meg újdonságainkat
- Legyen naprakész

Kínálatunk gyorsan és folyamatosan fejlődik!
Katalógusunk a 2021. áprilisi állapotot tükrözi.
Naprakész információért
látogasson el honlapunkra!

Világítástechnikai alapfogalmak

A fényáram a látható sugárzás fényérzetként felfogható része, mely sugárzás a fényforrást körülvevő tér egészébe sugárzik ki. Mértékegysége a **lumen** (lm) és ez a mérőszám adja a legjobb összehasonlítást két nem irányított sugárzási szögű (>120°) fényforrás között.

Két irányított sugárzási szögű fényforrás között azonban az egységnyi térszögbe kisugárzott fényáram mennyisége a megfelelő összehasonlító alap. Ennek egysége a **candela** (cd). Sajnos az előírások már csak a fényforrások fényáramának megadását írja elő, ami a szűkebb sugárzási szögű fényforrások esetén eltorzítja az összehasonlítást.

Egy felületnek a megvilágítását a felületre eső fényáram sűrűségével jellemezhetjük, melynek mértékegysége a **lux** (lx). Az egyes területek megvilágításának előírásait a világítástechnikai szabványok határozzák meg.

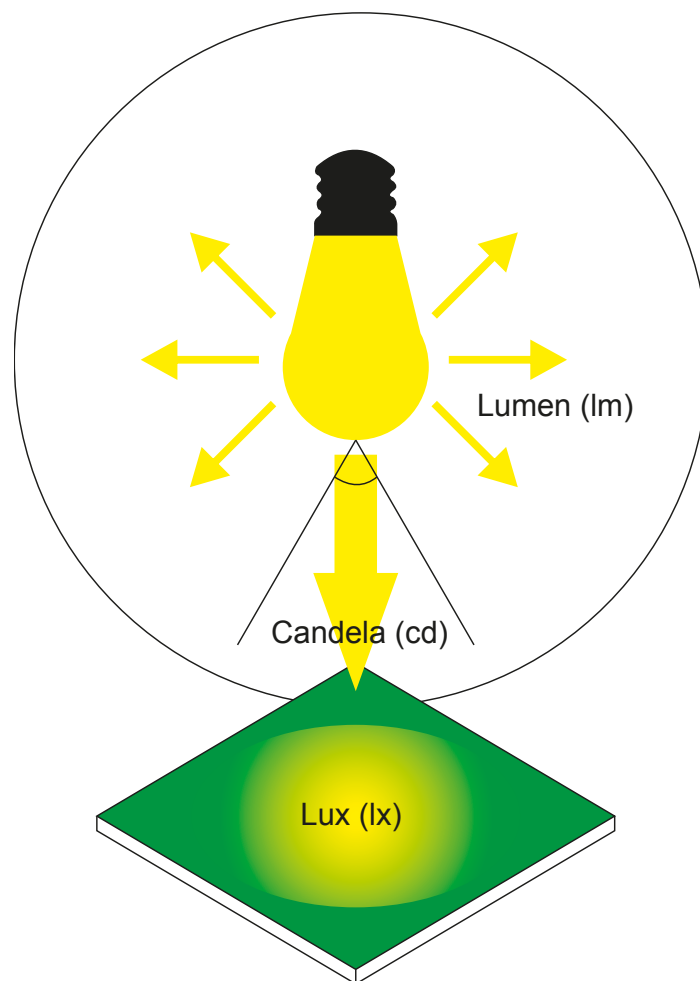

A színvisszaadási index (Ra) egy viszonyszám, mely azt mutatja meg, hogy a mesterséges világítás milyen hűen adja vissza a megvilágított tárgyak színét a napfényhez viszonyítva. A napfényt tekintjük 100-as indexűnek, az otthoni világításnál a 80-as index a minimum előírt, kültéri és ipari megvilágításnál ez a minimum index 70.

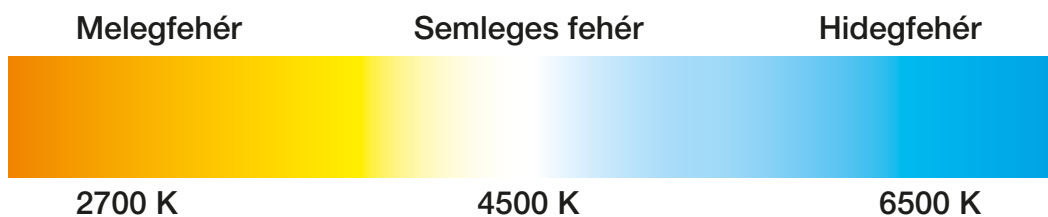

A mesterséges megvilágítás korrelált színhőmérsékletét Kelvin (K) fokban adják meg, mely alapvetően határozza meg a világítás hangulatát. A magasabb színhőmérséklet hidegebb, az alacsonyabb melegebb fényt jelöl.

A napsütés átlagosan 5500 K értékű, mely napkeltekor és napnyugtakor 4800 K körüli értékre változik. Általában a 2700 – 3500 K színhőmérséklet-tartományt nevezzük meleg, a 3500 – 5000 K tartományt a semleges és az 5000 – 6500 K tartományt hideg fénynek. Földrajzilag északabbra a meleg fényszín a kedveltebb, délebbre pedig a semleges és hideg fényszín.



OLVASSA BE A KÓDOT!

- Nézze meg újdonságainkat
- Legyen naprakész

Kínálatunk gyorsan és folyamatosan fejlődik!
Katalógusunk a 2021. áprilisi állapotot tükrözi.
Naprakész információért
látogasson el honlapunkra!

Előzetes világítás tervezés Relux programmal

Partnereink munkáját előzetes világítás tervezéssel tudjuk segíteni, hogy a projekteknel felhasznált Tracon világítótestek az előírásoknak megfelelő megvilágítást biztosítsanak a felhasználók számára. A megfelelő adategyeztetést követően ajánlatot tudunk adni a kiválasztott világítótestek mennyiségével és elhelyezésével kapcsolatban, illetve másik megoldást is felajánlunk abban az esetben, ha az megfelelő alternatívát jelenthet a projekt megvalósítására.

A tervezés vonatkozhat ipari csarnokokra, irodákra, fitnesztermekre, sportpályákra, parkolók és telephelyek megvilágítására és közvilágításra egyaránt.

A megvalósult tervezéseinkről beszéljenek a mellékelt tervek és a referencia életképek!

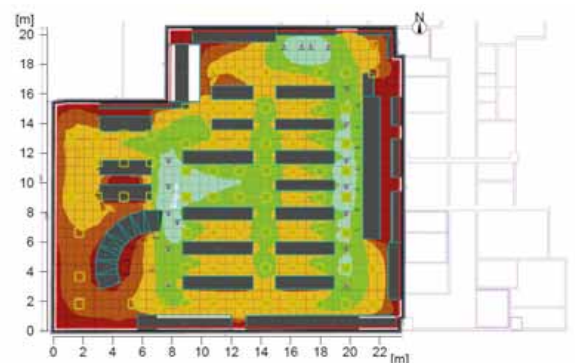
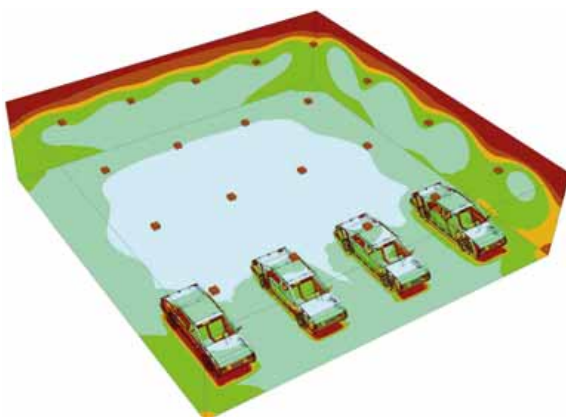
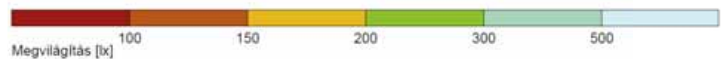
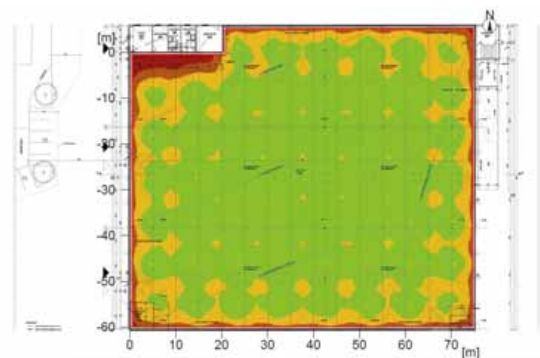
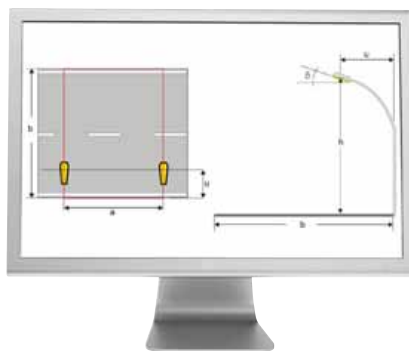
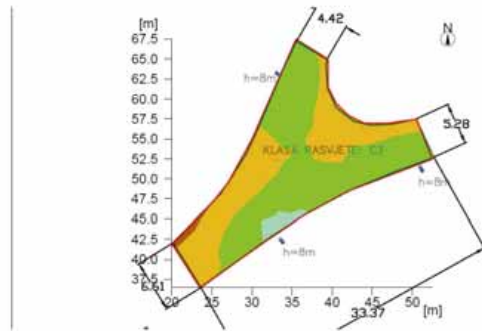

A világítástechnikai tervezések megkönnyítése érdekében a professzionális LED lámpatest-inkhez az általánosan használt tervező programokba (Dialux, Relux) könnyen beimportálható. IES formátumú fotometriai adatfájlok honlapunkról letölthetők.

.ies

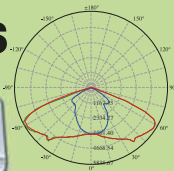



A LED technológia fejlődése napjainkra elérte azt a szintet, hogy a korábban elterjedt fémhalogén világításokat egy jobb hatásfokú, gazdaságosabb és könnyen szabályozható világításra lehet cserélni.

A könnyen számolható megtakarítás és a hosszú garanciaidő biztosítja a magasabb beruházási költség megtérülését.

A fémhalogén lámpatestek kiváltására ajánlott LED-es lámpatestek azonos munkasík megvilágítást biztosítanak.

A lámpatesteket az általánosan használt 4.000 - 4.500 K színhőmérséklettel ajánljuk, az ettől eltérő színhőmérsékletű termékeket felár ellenében szállítjuk.

Igény szerint a lámpatesteket intelligens, szabályozható meghajtóval is tudjuk szállítani!

A LED lámpatestekkel további villamos energia takarítható meg a fényerő szabályozásával és a nem használt lámpák lekapcsolásával, illetve mozgás-/jelenlét-érzékelőről való működtetésével.

Webáruházunkban megtalálja az összes LED-es lámpatest egyedi és részletes adatlapját, mely tartalmazza a fénygörbét, méretrajzokat, stb.

Kültéri LED csarnokvilágítók, LHBP széria

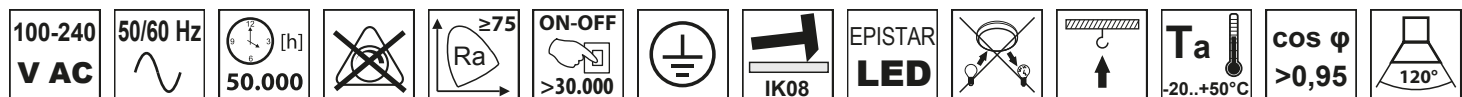

TRACON	[W]	LED	[lm]	Tc [K]	Ei
LHBP100W	100 W	250 W	9.000 lm	4.500 K	A
LHBP160W	160 W	400 W	14.400 lm	4.500 K	A
LHBP200W	200 W	500 W	18.000 lm	4.500 K	A

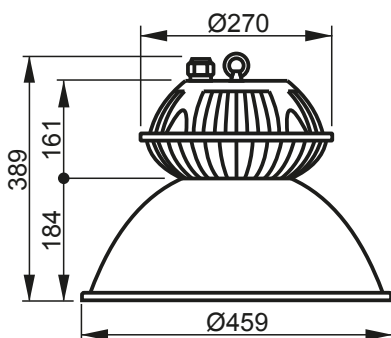

LHBP100W

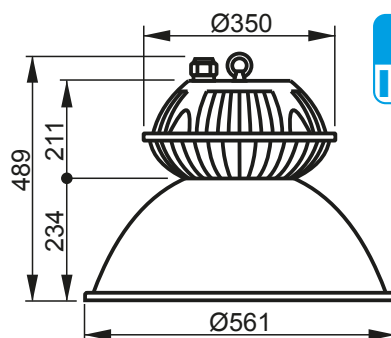

LHBP160W, LHBP200W



Kültéri LED csarnokvilágítók, LHBU széria

90-265 V AC 50/60 Hz 50.000 [h] Ra ≥75 ON-OFF >30.000 IK08 EPISTAR LED Ta -20..+50°C cos φ >0,95 120°

TRACON		LED	LED	Tc [K]	D (mm)	H1 (mm)	H2 (mm)	H3 (mm)	Ei	
LHBU60W	□	60 W	150 W	7.200 lm	4.500 K	256	48	92	110	A+
LHBU80W	⊕	80 W	200 W	9.700 lm	4.500 K	256	48	92	110	A+
LHBU100W	⊕	100 W	250 W	13.000 lm	4.500 K	320	66	132.5	170.5	A+
LHBU150W	⊕	150 W	400 W	19.500 lm	4.500 K	429	70	139	177	A
LHBU200W	⊕	200 W	500 W	26.000 lm	4.500 K	429	70	139	177	A

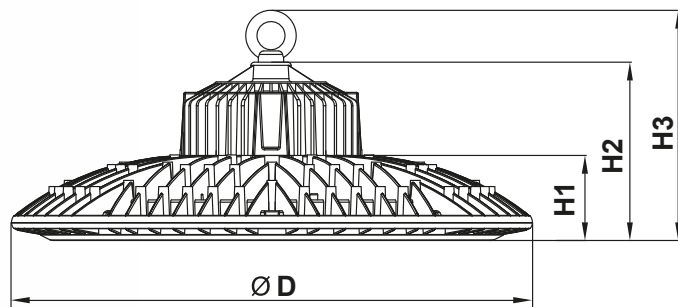

LED csarnokvilágító integrált meghajtóval

220-240 V AC 50/60 Hz 30.000 [h] ON-OFF >30.000 IK08 Ta -20..+50°C cos φ >0,95 Ra ≥75 IP 65

TRACON	LED	LED	Tc [K]	°	D × H (mm)	Ei	
LHBE100W	100 W	250 W	8.000 lm	4.500 K	120°	280 × 90	A
LHBE150W	150 W	400 W	12.000 lm	4.500 K	120°	340 × 95	A
LHBE200W	200 W	500 W	16.000 lm	4.500 K	120°	400 × 105	A

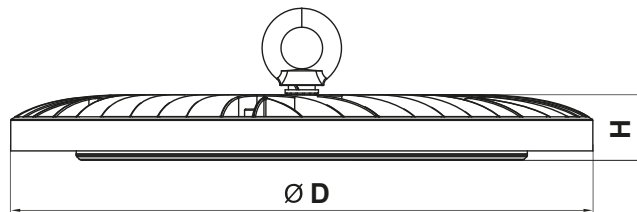

OLVASSA BE A KÓDOT!

- Nézze meg újdonságainkat
- Legyen naprakész

Kínálatunk gyorsan és folyamatosan fejlődik!
Katalógusunk a 2021. áprilisi állapotot tükrözi.

Naprakész információért
látogasson el honlapunkra!

LED csarnokvilágító, fényerő-szabályozható

90-265 V AC	50/60 Hz	50.000 [h]	Ra ≥75	ON-OFF >30.000	⏚	🏠	🔧	⬆️	Ta -20...+50°C	cos φ >0,95	IP 65	IK08	⦿
-----------------------	----------	------------	--------	-------------------	---	---	---	----	-------------------	----------------	-----------------	------	---

TRACON	💡	LED	💡 [lm]	⌒ [°]	Tc [K]	⦿	Ei
LHBH90W	90 W	250 W	12.150 lm	130/40°	4.000 K	1 – 10 V	A+
LHBH150W	150 W	400 W	20.250 lm	130/40°	4.000 K	1 – 10 V	A+

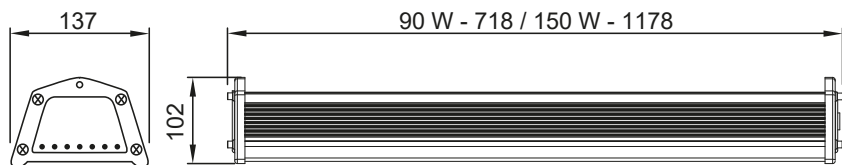

LHBH fényeloszlási görbe

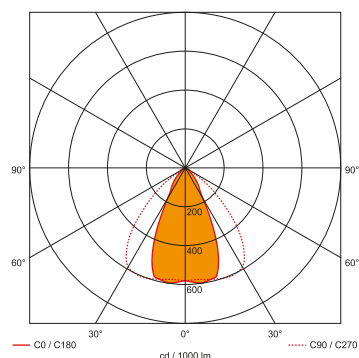

Sorolható védett LED ipari világítótest

230 V AC	50/60 Hz	50.000 [h]	Ra ≥80	Ta -20...+50°C	SMD LED	120°	IK08	max. 42 m	⏚
--------------------	----------	------------	--------	-------------------	----------------	------	------	--------------	---

TRACON	💡	LED	💡 [lm]	Tc [K]	💡 x LED	L x W x H (mm)	Ei
ML0620NW	20 W	2 x 18 W	2.600 lm	4.000 K	144 x SMD2835	600 x 73 x 55	A+
ML1240NW	40 W	2 x 36 W	5.200 lm	4.000 K	288 x SMD2835	1200 x 73 x 55	A+
ML1560NW	60 W	2 x 58 W	7.800 lm	4.000 K	432 x SMD2835	1500 x 73 x 55	A+
MLC2	-	-	-	-	-	3 x 0.75 mm ² , 2 m	-

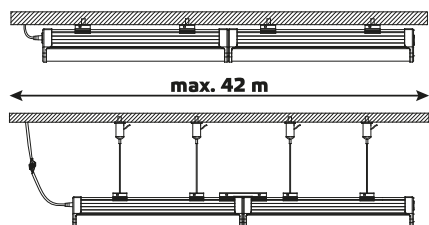

ML0620NW

ML1240NW

MLC2

LED utcai világítótest, LSJB széria (síküveggel)



TRACON		LED		Tc [K]		D × H	L (mm)	W (mm)	H (mm)	Ei
LSJB30W	30 W	70 W	3.800 lm	4.500 K	∅ 50 mm × 6 m	550	260	160	A+	
LSJB50W	50 W	150 W	6.800 lm	4.500 K	∅ 50 mm × 6 m	550	260	160	A+	
LSJB60W	60 W	200 W	7.800 lm	4.500 K	∅ 50 mm × 8 m	550	260	160	A+	
LSJB80W	80 W	250 W	10.400 lm	4.500 K	∅ 60 mm × 8 m	665	310	170	A+	
LSJB100W	100 W	300 W	13.000 lm	4.500 K	∅ 60 mm × 12 m	665	310	170	A+	
LSJB120W	120 W	400 W	15.000 lm	4.500 K	∅ 60 mm × 12 m	665	310	170	A+	
LSJB150W	150 W	550 W	19.500 lm	4.500 K	∅ 60 mm × 12 m	740	360	195	A+	
LSJB180W	180 W	600 W	24.000 lm	4.500 K	∅ 60 mm × 12 m	740	360	195	A+	
LSJB30WW	30 W	70 W	3.300 lm	2.700 K	∅ 50 mm × 6 m	550	260	160	A+	
LSJB50WW	50 W	150 W	5.500 lm	2.700 K	∅ 50 mm × 6 m	550	260	160	A+	
LSJB60WW	60 W	200 W	6.600 lm	2.700 K	∅ 50 mm × 8 m	550	260	160	A+	
LSJB80WW	80 W	250 W	8.800 lm	2.700 K	∅ 60 mm × 8 m	665	310	170	A+	
LSJB100WW	100 W	300 W	11.000 lm	2.700 K	∅ 60 mm × 12 m	665	310	170	A+	
LSJB120WW	120 W	400 W	13.200 lm	2.700 K	∅ 60 mm × 12 m	665	310	170	A+	
LSJB150WW	150 W	550 W	16.500 lm	2.700 K	∅ 60 mm × 12 m	740	360	195	A+	
LSJB180WW	180 W	600 W	19.800 lm	2.700 K	∅ 60 mm × 12 m	740	360	195	A+	

A világítótest villámcsapás következtében fellépő túlfeszültség elleni védelemre szolgáló eszköz: **TTVL2+3-10** (lásd F/11 oldal).
A termékcsalád alkalmas EON és ÉMÁSZ rendszereiben való hálózati csatlakozásra.

Figyelem! Az LSJB utcai világítótest családunkhoz nem használható az LSJAA906050 és az LSJAA906060 adapterünk.

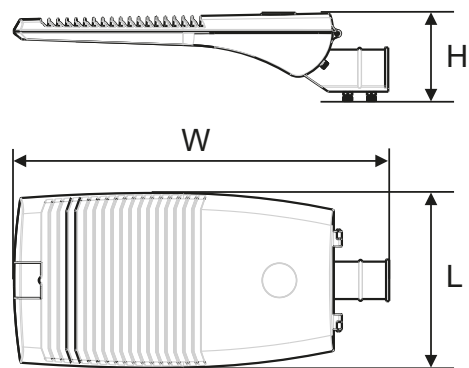

A Tracon Budapest Kft. a LED technológia fejlődésének követése mellett kiemelt figyelmet fordít a partnerei visszajelzéseire is. Ezek segítségével fejlesztettük ki az új LSJB termékcsaládunkat, melynek megbízhatóságát a Mean Well meghajtók és az CREE LED chipek garantálják. A kivitelezők munkáját a szerszám nélkül nyitható ház, az oszlopfőre és oszlopkarra szerelhetőséget egyaránt lehetővé tevő állítható dőlésszögű nyak, valamint a rövidzár elleni védelmet nyújtó üvegbiztosító segíti. A világítás megfelelő minőségét a káprázás- és villogásmentes LED-ek szavatolják, a világítótest ULOR értéke az európai előírásoknak megfelelően 0.

Ez utóbbi kiemelten fontos a fényszennyezés elleni küzdelemben, hiszen így a világítótestek nem bocsájtanak ki fényt a világítótest vízszintes síkja fölé.

LSJB fényeloszlási görbe

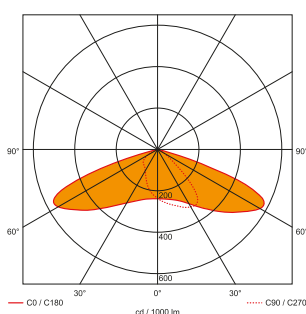

LSJB szerelési módok

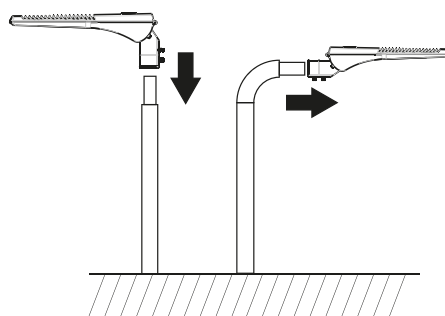

LED utcai világítótest, LSJA széria



TRACON			LED		Tc [K]		D × H	L (mm)	W (mm)	B (mm)	∅ (mm)	Ei
LSJA20W	1 × 20 W	50 W	2.000 lm	4.500 K	∅ 40 mm × 6 m	410	170	81	40	A+		
LSJA30W	1 × 30 W	70 W	3.000 lm	4.500 K	∅ 50 mm × 6 m	500	214	81	50	A+		
LSJA50W	1 × 50 W	120 W	5.000 lm	4.500 K	∅ 50 mm × 6 m	500	214	81	50	A+		
LSJA50WW	1 × 50 W	120 W	5.000 lm	2.700 K	∅ 50 mm × 6 m	500	214	81	50	A+		
LSJA60W	1 × 60 W	150 W	6.000 lm	4.500 K	∅ 50 mm × 6 m	500	214	81	50	A+		
LSJA80W	1 × 80 W	200 W	8.000 lm	4.500 K	∅ 60 mm × 8 m	620	260	101	60	A+		
LSJA100W	2 × 50 W	250 W	10.000 lm	4.500 K	∅ 60 mm × 8 m	700	280	112	65	A		
LSJA120W	2 × 60 W	300 W	12.000 lm	4.500 K	∅ 60 mm × 8 m	700	280	112	65	A		
LSJA150W	3 × 50 W	400 W	15.000 lm	4.500 K	∅ 60 mm × 12 m	880	340	122	65	A		
LSJA180W	3 × 60 W	500 W	18.000 lm	4.500 K	∅ 60 mm × 12 m	880	340	122	65	A		
LSJA200W	4 × 50 W	550 W	20.000 lm	4.500 K	∅ 73 mm × 12 m	1100	420	126	73	A		
LSJA240W	4 × 60 W	600 W	24.000 lm	4.500 K	∅ 73 mm × 12 m	1100	420	126	73	A		

A világítótest villámcsapás következtében fellépő túlfeszültség elleni védelemre szolgáló eszköz: **TTVL2+3-10** (lásd F/11 oldal).

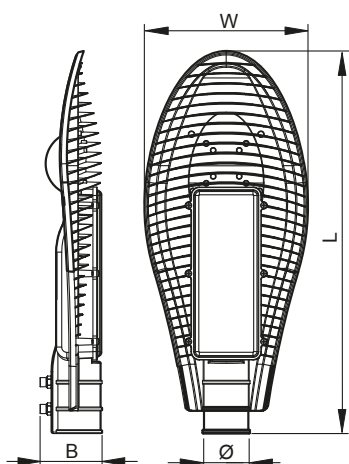

A termékcsalád alkalmas EON és ÉMÁSZ rendszereiben való hálózati csatlakozásra!



LED utcai világítótest, LSJR széria



TRACON			LED		Tc [K]		L × W × H (mm)	Ei
LSJR30W	30 W	50 W	2.400 lm	4.500 K	∅ 50 mm × 6 m	495 × 215 × 70	A	
LSJR50W	50 W	100 W	4.000 lm	4.500 K	∅ 50 mm × 6 m	495 × 215 × 70	A	
LSJR100W	100 W	200 W	8.000 lm	4.500 K	∅ 60 mm × 8 m	700 × 270 × 75	A	

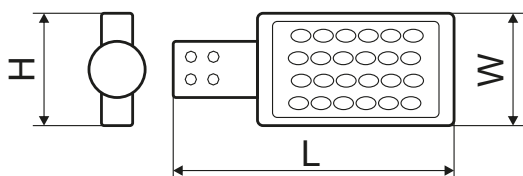

LED utcai világítótest, LSJK széria

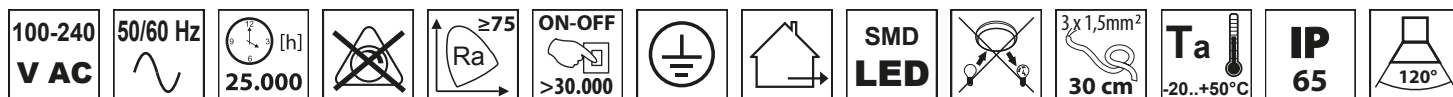

Kiegészítők



LSJKAV	Lámpafej-adapter LSJK utcai világítótestekhez, vízszintes csőre, 50 mm
LSJKAF	Lámpafej-adapter LSJK utcai világítótestekhez, függőleges csőre, 50 mm
LSJAA	Oszlop adapter LSJA30W/50W/60W, LSJB30W/50W/60W és LSJR30W/50W utcai világítótestekhez, 50/63 mm
LSJAA906050	Állítható lámpafej-adapter (LSJA30W/50W/60W és LSJR30W/50W) utcai világítótestekhez, (0/90°) -10° - +20°, 50/60 mm
LSJAA906060	Állítható lámpafej-adapter (LSJA80W-180W) utcai világítótestekhez, (0/90°) -10° - +20°, 60/60 mm
LSJFK4060	Fali konzol utcai világítótestekhez, 40mm, 60° (LSJA20W)
LSJFK5060	Fali konzol utcai világítótestekhez, 50mm, 60° (LSJA30W/50W/50WW/60W, LSJB30W/30WW/50W/50WW/60W/60WW és LSJR30W/50W)
LSJFK6060	Fali konzol utcai világítótestekhez, 60mm, 60° (LSJA80W-240W, LSJB80W-180W, LSJB80WW-180WW és LSJR100W)

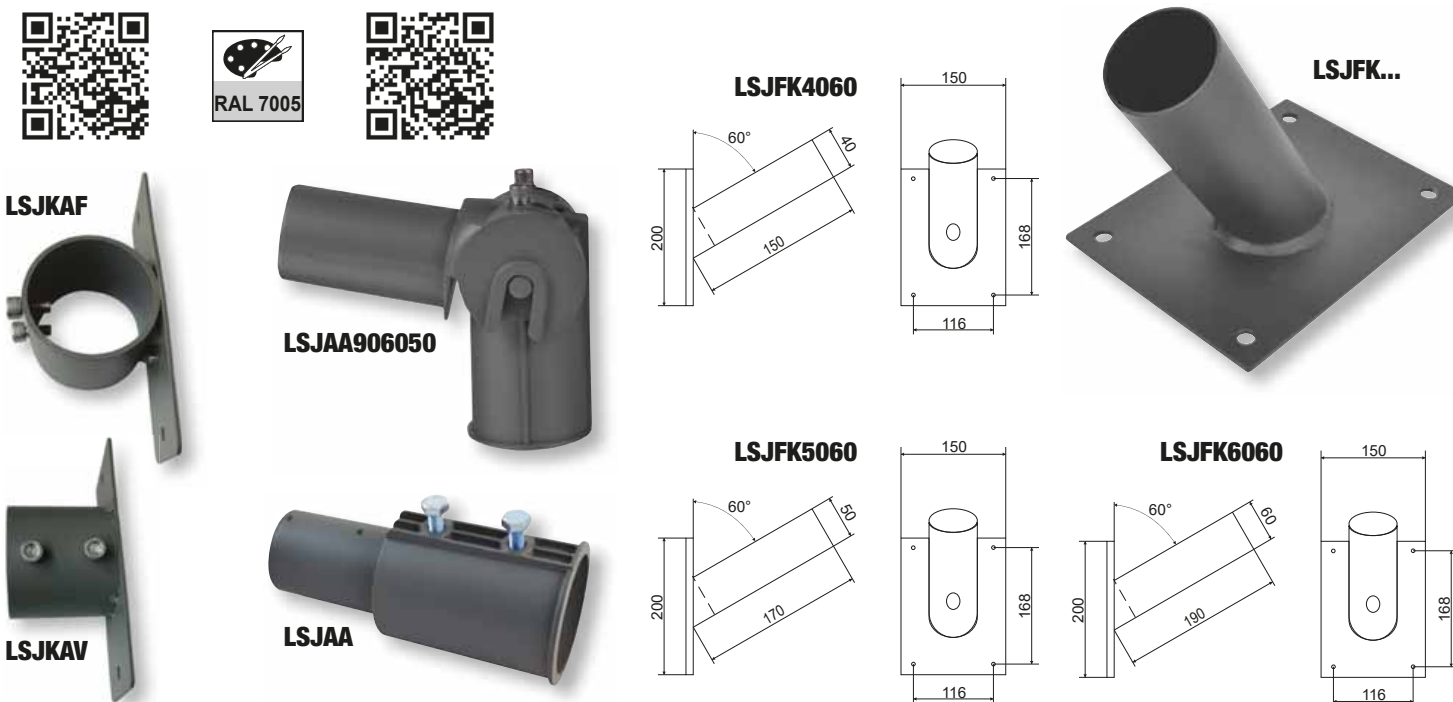

LSJAA: Az 30-60W teljesítményű LSJA lámpatestek 50mm fejméretű oszlopokhoz készülnek. Az opcionálisan elérhető LSJAA adapter használatával ezek a lámpatestek 63 mm fejméretű oszlopokra is felszerelhetők.

Figyelem! Az LSJB utcai világítótest családunkhoz nem használható az LSJAA906050 és az LSJAA906060 adapterünk.

Napelemes utcai LED világítótest mozgásérzékelővel



TRACON					P_{max}			L x W x H (mm)
LSLS15W	15 W	1.600 lm	4.000 K	7,4 V / 5,4 Ah Li-ion	21 W, 9,5 V	4 m	–	493 x 232 x 58
LSLS40W	40 W	4.800 lm	4.000 K	9,6 V / 12 Ah Li-FePo	21 W, 13,5 V	4 m	✓	706 x 290 x 74

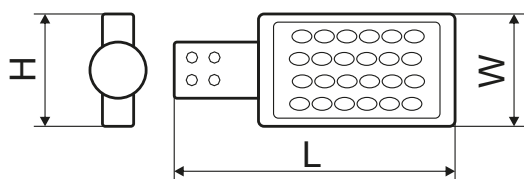
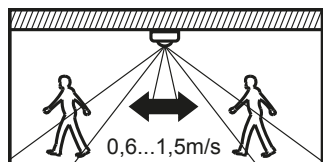

LSLS15W



LSLS40W

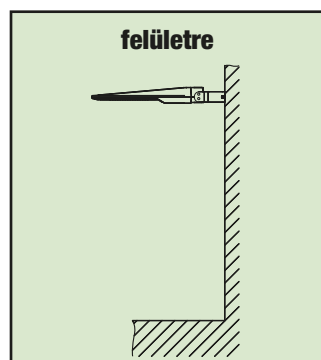

„A” mód - Folyamatos működés



Nyomja meg a Be/Kikapcsoló gombot 1x, vagy a távirányító gombját, a lámpa automatikusan bekapcsol és 4 órán keresztül folyamatosan üzemel, majd mozgásérzékelő módba vált.

„B” mód - Érzékelős működés



Nyomja meg a Be/Kikapcsoló gombot 2x, vagy a távirányító gombját, a lámpa mozgás érzékelésekor automatikusan 100 %-os fényerőre kapcsol. Amennyiben a lámpa 20 másodpercig nem érzékel mozgást, akkor a fényerő 30 %-ra csökken.



LED fényvetők, RSMDB széria



TRACON					L (mm)	W (mm)	H (mm)		
RSMDB10W	10 W	-	850 lm	4.500 K	198	160	45	120°	A
RSMDB20W	20 W	-	1.700 lm	4.500 K	198	160	45	120°	A
RSMDB30W	30 W	70 W	2.550 lm	4.500 K	320	220	61	120°	A
RSMDB50W	50 W	120 W	4.250 lm	4.500 K	320	220	61	120°	A
RSMDB80W	80 W	200 W	6.800 lm	4.500 K	357	320	68	120°	A
RSMDB100W	100 W	250 W	8.500 lm	4.500 K	357	320	68	120°	A
RSMDB120W	120 W	300 W	10.200 lm	4.500 K	450	360	76	120°	A
RSMDB150W	150 W	400 W	12.750 lm	4.500 K	450	360	76	120°	A

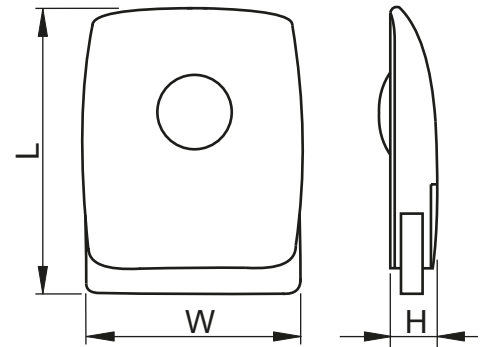

LED fényvetők, R-SMDP széria



TRACON	[W]	LED	[lm]	Tc [K]	L (mm)	W (mm)	H (mm)	[°]	
R-SMDP-50W	50 W	100 W	4.000 lm	4.500 K	323	242	79	120°	A
R-SMDP-80W	80 W	150 W	6.400 lm	4.500 K	323	242	79	120°	A
R-SMDP-100W	100 W	200 W	8.000 lm	4.500 K	461	381	129	120°	A
R-SMDP-200W	200 W	500 W	16.000 lm	4.500 K	630	470	165	120°	A

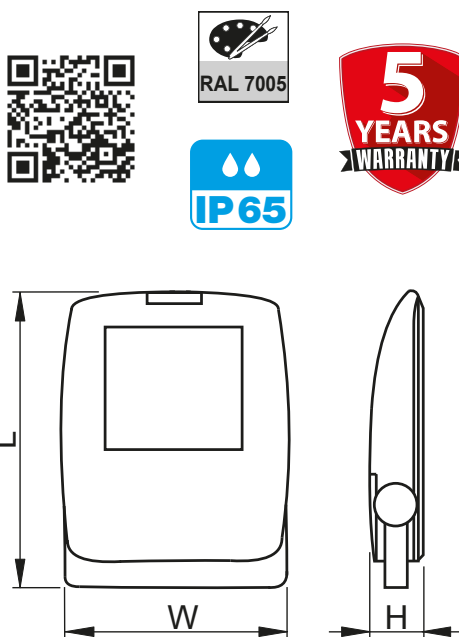

Tömítőszelencés kábeltoldó

TRACON	mm ²	
CST1	0.5-1	PG9
CST4	0.5-4	MG25
CST4-T	0.5-4	MG25
CST4-Y	0.5-4	MG25
CST15B	0.5-1.5	MG20
CST15W	0.5-1.5	MG20
CST25	0.5-2.5	MG20
CST25F	0.5-2.5	MG20
CSTBOX	0.5-1	PG9



CST15W



CSTBOX



OLVASSA BE A KÓDOT!

- Nézze meg újdonságainkat
- Legyen naprakész

Kínálatunk gyorsan és folyamatosan fejlődik!
Katalógusunk a 2021. áprilisi állapotot tükrözi.
Naprakész információért
látogasson el honlapunkra!

LED fényvető, szimmetrikus, RHIS széria

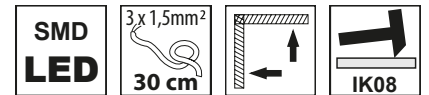

TRACON					L (mm)	W (mm)	H (mm)			
RHISS100W	100 W	250 W	13.500 lm	4.000 K	413	366	83		120°	A+
RHISS150W	150 W	400 W	20.250 lm	4.000 K	413	366	83		120°	A+
RHISS240W	240 W	750 W	32.400 lm	4.000 K	462	452	87		120°	A+
RHISA100W	100 W	250 W	13.500 lm	4.000 K	413	366	83		–	A+
RHISA150W	150 W	400 W	20.250 lm	4.000 K	413	366	83		–	A+
RHISA240W	240 W	750 W	32.400 lm	4.000 K	462	452	87		–	A+
RHIS30100W	100 W	250 W	13.500 lm	4.000 K	413	366	83		30°	A+
RHIS30150W	150 W	400 W	20.250 lm	4.000 K	413	366	83		30°	A+
RHIS30240W	240 W	750 W	32.400 lm	4.000 K	462	452	87		30°	A+

A: aszimmetrikus
S: szimmetrikus

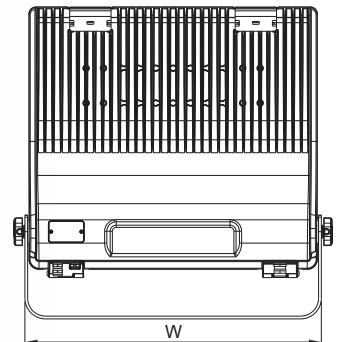
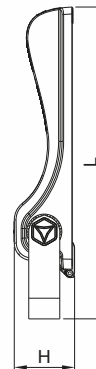

RHIS30 fényeloszlási görbe

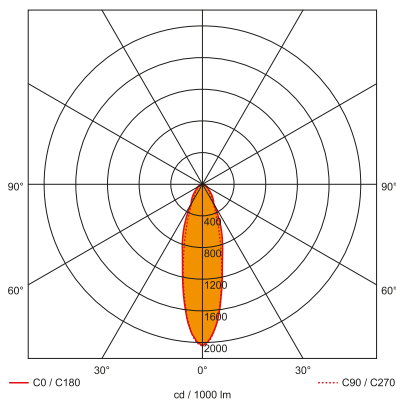

RHISA fényeloszlási görbe

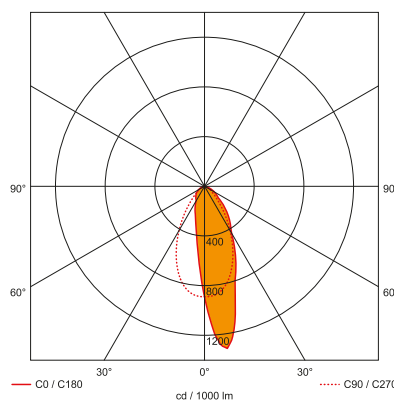

RHISS fényeloszlási görbe

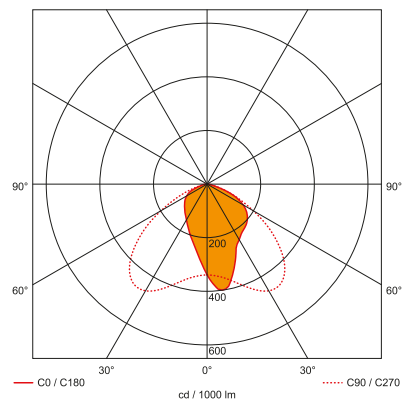

OLVASSA BE A KÓDOT!

- Nézze meg újdonságainkat
- Legyen naprakész

Kínálatunk gyorsan és folyamatosan fejlődik!
Katalógusunk a 2021. áprilisi állapotot tükrözi.
Naprakész információért látogasson el honlapunkra!

LED fényvetők, RSMDL széria

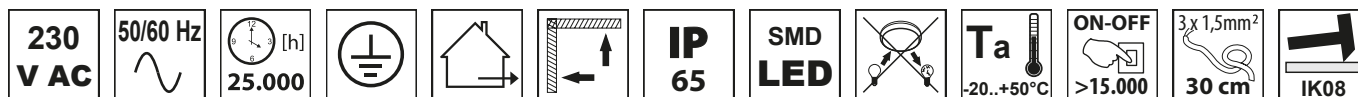

TRACON						
RSMDL10	10 W	70 W	750 lm	4.000 K	105 × 75 × 55	A
RSMDL20	20 W	150 W	1.500 lm	4.000 K	136 × 95 × 55	A
RSMDL20WW	20 W	150 W	1.400 lm	3.000 K	136 × 95 × 55	A
RSMDL30	30 W	250 W	2.700 lm	4.000 K	170 × 120 × 65	A
RSMDL50	50 W	400 W	3.750 lm	4.000 K	203 × 142 × 65	A
RSMDL50WW	50 W	400 W	3.450 lm	3.000 K	203 × 142 × 65	A
RSMDL100	100 W	750 W	7.500 lm	4.000 K	334 × 229 × 76	A
RSMDL150	150 W	1.000 W	10.000 lm	4.000 K	398 × 275 × 80	A
RSMDL200	200 W	1.500 W	14.000 lm	4.000 K	430 × 305 × 80	A
RSMDLM10	10 W	70 W	750 lm	4.000 K	105 × 75 × 55	A
RSMDLM20	20 W	150 W	1.500 lm	4.000 K	136 × 95 × 55	A
RSMDLM30	30 W	250 W	2.700 lm	4.000 K	170 × 120 × 65	A
RSMDLM50	50 W	400 W	3.750 lm	4.000 K	203 × 142 × 65	A



RSMDL10



RSMDL100



RSMDLM10



RSMDLM50

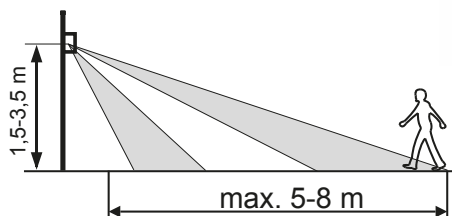
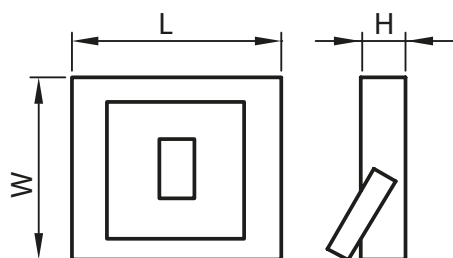

LED fényvetők, RSMDLF széria

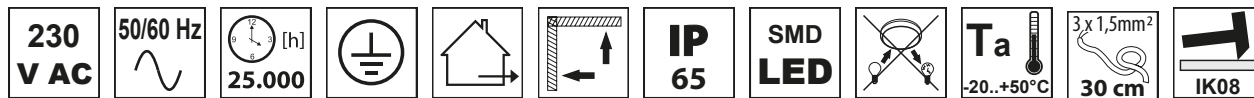

TRACON						
RSMDLF10	10 W	70 W	750 lm	4.000 K	105 × 75 × 55	A
RSMDLF20	20 W	150 W	1.500 lm	4.000 K	136 × 95 × 55	A
RSMDLF20WW	20 W	150 W	1.400 lm	3.000 K	136 × 95 × 55	A
RSMDLF30	30 W	250 W	2.700 lm	4.000 K	170 × 120 × 65	A
RSMDLF50	50 W	400 W	3.750 lm	4.000 K	203 × 142 × 65	A
RSMDLF50WW	50 W	400 W	3.450 lm	3.000 K	203 × 142 × 65	A
RSMDLF100	100 W	750 W	7.500 lm	4.000 K	334 × 229 × 76	A
RSMDLFM10	10 W	70 W	750 lm	4.000 K	105 × 75 × 55	A
RSMDLFM20	20 W	150 W	1.500 lm	4.000 K	136 × 95 × 55	A
RSMDLFM30	30 W	250 W	2.700 lm	4.000 K	170 × 120 × 65	A
RSMDLFM50	50 W	400 W	3.750 lm	4.000 K	203 × 142 × 65	A



RSMDLF100



RSMDLF10



RSMDLFM10



RSMDLFM50

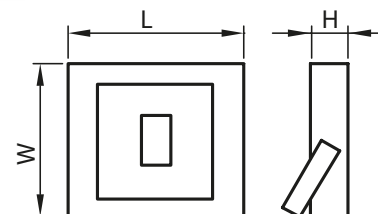
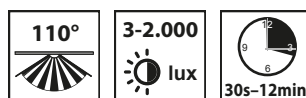
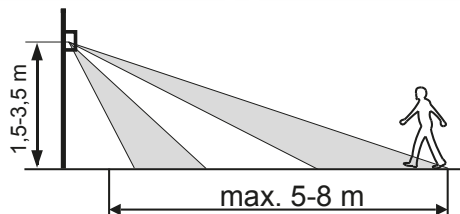

LED fényvetők, RSMDL..H széria (vezeték nélküli)



TRACON						L x W x H (mm)	
RSMDL20H	20 W	150 W	1.500 lm	4.000 K		136 x 95 x 55	A
RSMDL50H	50 W	400 W	3.750 lm	4.000 K		203 x 142 x 65	A
RSMDLM10H	10 W	70 W	750 lm	4.000 K		142 x 165 x 63	A
RSMDLM20H	20 W	150 W	1.500 lm	4.000 K		142 x 165 x 63	A
RSMDLM30H	30 W	250 W	2.700 lm	4.000 K		175 x 185 x 64	A
RSMDLM50H	50 W	400 W	3.750 lm	4.000 K		205 x 205 x 64	A

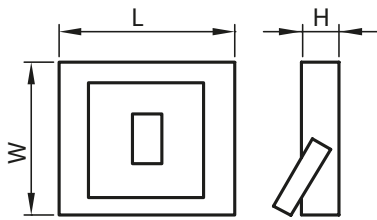

RSMDL..H

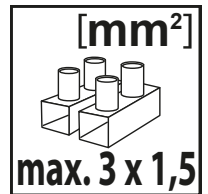
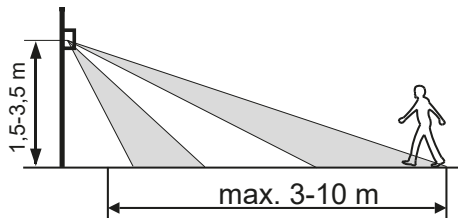

RSMDLM..H

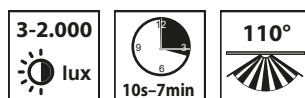
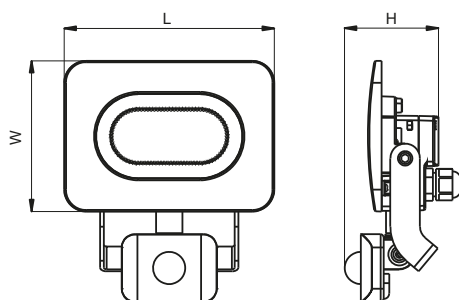

Hordozható / szerelő LED fényvetők

100-240 V AC 50/60 Hz Ra ≥75 30.000 [h] Ta -20...+50°C 120°

Piktogramok E/5

TRACON				Tc [K]	h (mm)			
RSMDAE10W	10 W	70 W	600 lm	4.500 K	-	4 h	3,7 V / 4 Ah Li-Ion	A
RSMDAE20W	20 W	150 W	1.200 lm	4.500 K	-	4 h	8,4 V / 10 Ah Li-Ion	A
RSMDAW30W	30 W	250 W	2.400 lm	4.000 K	-	-	-	A
RSMDTRI10W	10 W	70 W	800 lm	4.000 K	-	2,5 h	3,7 V / 4,4 Ah Li-Ion	A+
RSMDAW220W	2 × 20 W	2 × 150 W	2 × 1.600 lm	4.000 K	800-1.500	-	-	A
RSMDAW230W	2 × 30 W	2 × 250 W	2 × 2.400 lm	4.000 K	800-1.500	-	-	A
RSMDALV	-	-	-	-	800-1.500	-	-	-

RSMDAE...
2 YEARS WARRANTY
IP54

RSMDAW30W
2 YEARS WARRANTY
IP65

RSMDTRI10W
2 YEARS WARRANTY
IP44

QR code
Levehető egység hordfülrel
2 YEARS WARRANTY
IP65
RSMDAW220W
RSMDAW230W
800-1500 mm

IP65

RSMDALV
2 YEARS WARRANTY
m
max. 25 kg
800-1500 mm

Hordozható LED fényvető - profi



TRACON				Tc [K]	OUT			
STLFL10W	10 W	70 W	1.000 lm	6.500 K	✓	3 h	3,7 V / 4,4 Ah Li-Ion	A
STLFLBT15W	15 W	120 W	1.500 lm	6.000 K	✓	4-10 h	3,7 V / 8 Ah Li-Ion	A
STLFL210W	20 W	150 W	850 lm	6.500 K	-	4 h	3,7V / 5 Ah Li-ion	A

STLFLBT15W

2 YEARS WARRANTY

Bluetooth™

IP40

STLFL10W

2 YEARS WARRANTY

IP54

STLFL210W

2 YEARS WARRANTY

IP43

TRACON ELECTRIC®

NAR MODULÁRIS RELÉK

J/10-J/17

Napelemes LED fényvető mozgásérzékelővel

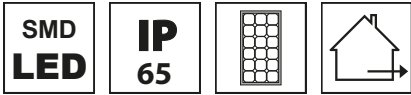

TRACON			Tc [K]		P _{max}	L x W x H (mm)
LSFL5W	5 W	50 / 500 lm	4.000 K	3,7 V / 3 Ah Li-Ion	2,3 Wp	218 x 150 x 34
LSFL10W	10 W	30 / 1.080 lm	4.000 K	3,7 V / 7,2 Ah Li-Ion	6 Wp	300 x 215 x 35

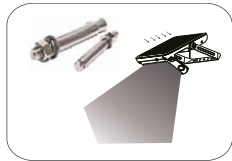

Szerelés falra (5 W és 10 W)

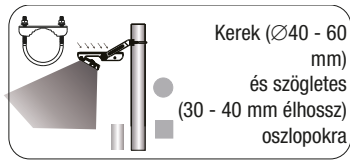

Szerelés oszlopra (csak 10 W)

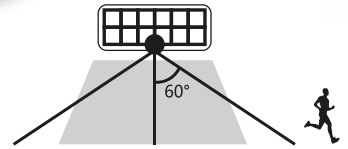
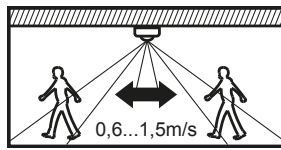

Be- és kikapcsolás

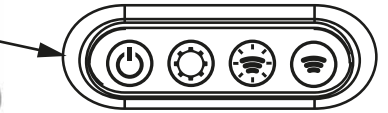

Be- és kikapcsolás

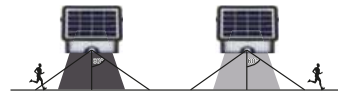

Ha az akkumulátor kapacitása 30 % felett van, akkor a fényvető alapfényre kapcsol, ha 20 másodpercen keresztül nem észlel mozgást.



Sötétedés után a fényvető automatikusan bekapcsol és folyamatosan 20 %-os fényerővel világít.

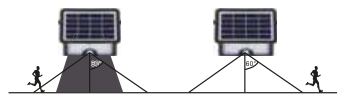

Ha az akkumulátor kapacitása 30 % alatt van, akkor a fényvető kikapcsol, ha 20 másodpercen keresztül nem észlel mozgást.

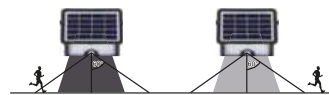

Sötétedés után a fényvető mozgásra bekapcsol 100 % -os fényerőre, ha nem érzékel mozgást 20 másodpercig, akkor 3 %-ra kapcsol.



A bekapcsoló gombot 3 másodpercnél hosszabb ideig nyomva tartva a fényvető folyamatos üzemmódra vált, az alkonykapcsoló és a mozgásérzékelő ekkor nem működik, a folyamatos világítás az akkumulátor teljes lemerüléséig fennmarad.

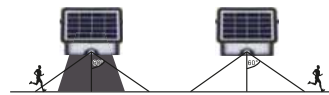

Sötétedés után a fényvető mozgásra bekapcsol 100 % -os fényerőre, ha nem érzékel mozgást 30 másodpercig, akkor kikapcsol.

Napelemes LED fali világítótest mozgásérzékelővel

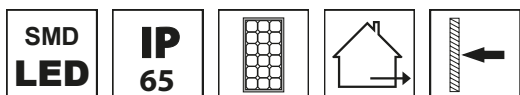

TRACON					P_{max}	L x W x H (mm)	
LSLBB3W	3,2 W	400 lm	4.000 K	3,7 V / 2 Ah Li-ion	2,3 Wp	212 x 140 x 110	
LSLBW3W	3,2 W	400 lm	4.000 K	3,7 V / 2 Ah Li-ion	2,3 Wp	212 x 140 x 110	
LSLBB7W	6,8 W	800 lm	4.000 K	3,7 V / 4 Ah Li-ion	4,4 Wp	270 x 221 x 110	
LSLBW7W	6,8 W	800 lm	4.000 K	3,7 V / 4 Ah Li-ion	4,4 Wp	270 x 221 x 110	

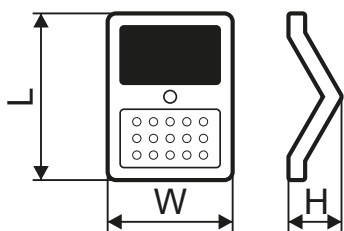
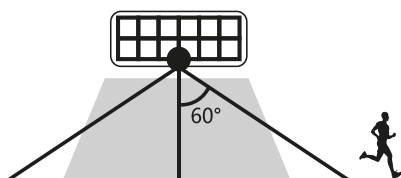
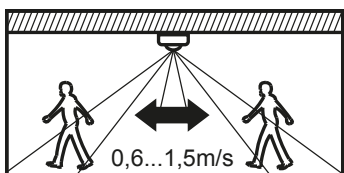

Be- és kikapcsolás, üzemmód választás (A, B és C üzemmód)

<p>„A” üzemmód: Sötétben automatikusan bekapcsol, és 5 órán keresztül 20 %-os fényerővel világít.</p>	<p>„B” üzemmód: Sötétben automatikusan bekapcsol, mozgás érzékelésekor 100 %-os fényerővel világít. Ha 20 másodpercig nem érzékel mozgást 3 %-os fényerőre vált.</p>	<p>„C” üzemmód: Sötétben automatikusan bekapcsol, mozgás érzékelésekor 100 %-os fényerővel világít. Ha 30 másodpercig nem érzékel mozgást lekapcsol.</p>
--	---	---









OLVASSA BE A KÓDOT!

- Nézze meg újdonságainkat
- Legyen naprakész

**Kínálatunk gyorsan és folyamatosan fejlődik!
Katalógusunk a 2021. áprilisi állapotot tükrözi.
Naprakész információért látogasson el honlapunkra!**

LED biciklilámpák

TRACON		 [lm]	 Tc [K]	 [h]		
BLCS3W	3 W	200 lm	6.000 K	~ 6/12 h	3,7 V / 1200 mAh Li-Ion	6/12 h
BLCE3W *	3 W	250 lm	6.000 K	~ 5 h	3 × AAA 1,5 V	–
BLCA3W	3 W	250 lm	6.000 K	6/12 h	3,7 V / 1200 mAh Li-Ion	6 h
BLCR2W	2 W	150 lm	5.000 K	2/5 h	3,7 V / 800 mAh	2,5 h
BLCH1,5W	1,5 W	100 lm	–	2 h	3,7 V / 500 mAh	2 h

* Az elem nem tartozék!

BLCS3W





- Napelem
- Akkumulátor



BLCE3W



* Az elem nem tartozék!



BLCA3W



- Akkumulátorral



BLCR2W



- Első-hátsó világítással
- Akkumulátorral

BLCH1,5W









- Akkumulátorral



Éjszakai fények

100-240 V AC    **IP 20**

TRACON		L × W × H (mm)
NL	1 W	55 × 115 × 70
NLS*	1 W	55 × 115 × 70

* fényérzékelővel

NL





Alap kivitel **NLS**

Fényérzékelővel



LED fejlámpák



TRACON							
HL500B	4,5 W	500 lm	6.000 K	5 h	3,7 V / 1,5 Ah Li-Po	-	✓
HL120B	3 W	120 lm	6.000 K	5 h	3,7 V / 1,2 Ah Li-Po	✓	-
HL120E *	3 W	120 lm	6.000 K	~12 h	3 × AAA 1,5 V	-	-

* Az elem nem tartozék!



Autós vészjelző lámpa

TRACON						
STEM1,5W *	1,5 W	100 lm	-	~ 2 h	3 × AAA	2 h
STEM10W	10 W	500 lm	6.500 K	4 h	3,7 V / 4 Ah Li-ion	4 h



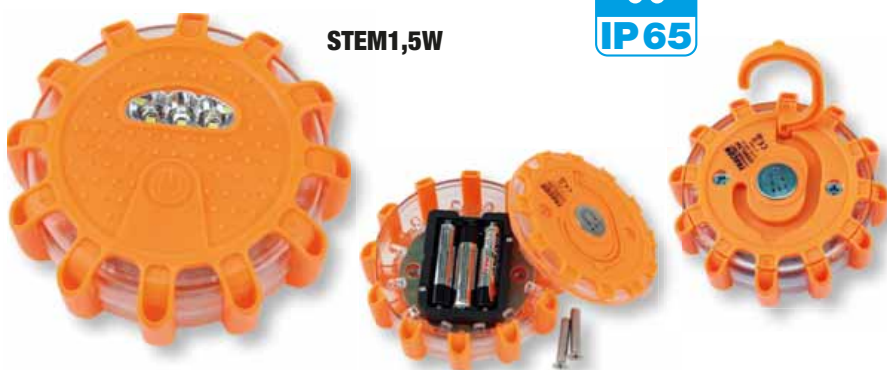





* Az elem nem tartozék!



Figyelem! Csak az előírt elakadásjelzővel együtt alkalmazható!









LED kézi lámpák

TRACON	 [W]	 [lm]	 Tc [K]	 [h]	 IN USB	 V	 OUT USB	
STLM4W	3/1 W	300/100 lm	6.000 K	3 h	✓	3,7 V / 2,2 Ah Li-Ion	–	5 h
STLUSB2W	2 W	200 lm	6.000 K	3 h	✓	3,7 V / 1,8 Ah Li-Ion	✓	3 h
STLE2W *	2/0,5 W	200/100 lm	6.000 K	~ 4 h	–	3 × 1,5 V AAA	–	–
STLT2W	2/2 W	150/150 lm	6.000 K	3 h	✓	3,7 V / 1,4 Ah Li-Ion	–	4 h
STLEL8W *	8 W	800 lm	6.000 K	~ 10 h	–	3 × 1,5 V "D" - LR20	–	–
STLAL5W	5 W	200 lm	6.000 K	3 h	✓	3,7 V / 1,8 Ah Li-Ion	–	3,5 h

* Az elem nem tartozék!



LED kézi lámpák

TRACON	 [W]	 [lm]	 Tc [K]	 [h]	 IN	 V	
STLC5W	5/3 W	360/100 lm	6.000 K	4 h	✓	3,7 V / 2Ah Li-ion	3 h
STLHL5W	5/1 W	500/100 lm	6.500 K	3/12 h	-	3,7 V / 4,4 Ah Li-ion	4 h
STLHL10W	10/3 W	1.000/220 lm	6.500 K	3/9 h	-	3,7 V / 6,6 Ah Li-ion	4 h
STLC0B3W	3/3 W	100/180 lm	6.000 K	3,5 h	✓	3,7 V / 2 Ah Li-ion	2,5 h
STLCAMP10W *	10/4 W	600/200 lm	6.000 K	3/16 h	✓	3,7 V / 1,8 Ah Li-ion / 3 × D+6 × AAA	4 h
KL600B	4,5 W	500 lm	6.000 K	3 h	-	3,7 V / 1,5 Ah Li-ion	2 h
STLBT10W	10/3 W	500/100 lm	6.000 K	3 h	✓	3,7 V / 3 Ah Li-Po	5 h

* Az elem nem tartozék!

STLHL5W - 5W
STLHL10W - 10W



MÁGNES

2 YEARS WARRANTY

IP54

TRACON ELECTRIC
1.000 LUMENS

STLBT10W



2 YEARS WARRANTY

IP44

MÁGNES

Bluetooth™

STLC5W



2 YEARS WARRANTY

IP44

MÁGNES

STLC0B3W



2 YEARS WARRANTY

IP44

MÁGNES

STLCAMP10W



2 YEARS WARRANTY

IP44

USB

Az elem nem tartozék!

KL600B



2 YEARS WARRANTY

IP54

*** STROBE

Zoom

100/50%

Kerek, beépíthető LED panel

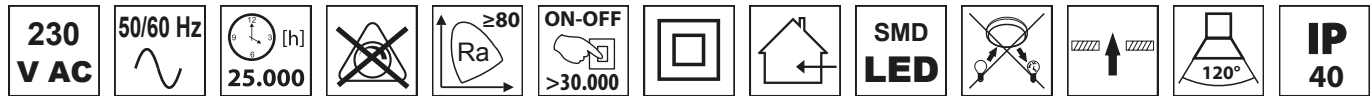

TRACON						D x H (mm)	
LED-DL-6NW	6 W	1 x 13 W	390 lm	4.000 K	105 mm	118 x 20	A
LED-DL-12WW	12 W	1 x 26 W	850 lm	2.700 K	150 mm	168 x 20	A
LED-DL-12NW	12 W	1 x 26 W	850 lm	4.000 K	150 mm	168 x 20	A
LED-DL-18WW	18 W	2 x 26 W	1.300 lm	2.700 K	200 mm	220 x 20	A
LED-DL-18NW	18 W	2 x 26 W	1.300 lm	4.000 K	200 mm	220 x 20	A

A lámpatestek a hálózati működtetéshez szükséges meghajtó egységeket és a LED fényforrásokat egyaránt tartalmazzák.

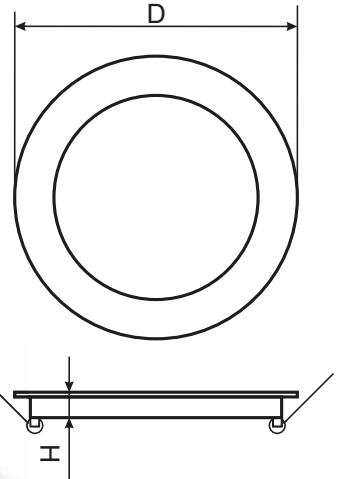

Négyzet alakú, beépíthető LED panel

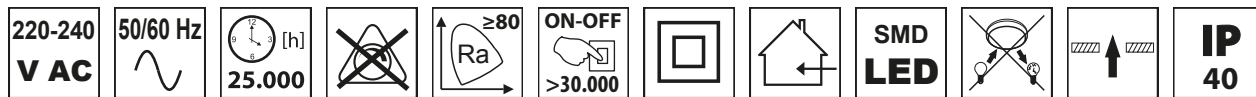

TRACON						D x H (mm)	
LED-DLN-6NW	6 W	1 x 13 W	400 lm	4.000 K	110 x 110 mm	120 x 20	A
LED-DLN-12NW	12 W	1 x 26 W	850 lm	4.000 K	160 x 160 mm	172 x 20	A
LED-DLN-18NW	18 W	2 x 26 W	1.300 lm	4.000 K	215 x 215 mm	225 x 20	A

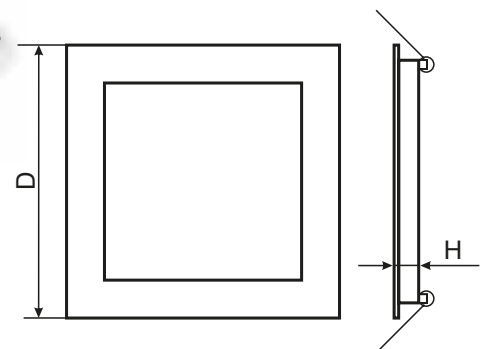

A lámpatestek a hálózati működtetéshez szükséges meghajtó egységeket és a LED fényforrásokat egyaránt tartalmazzák.

Inverteres vészvilágító kiegészítő egység LED panelekhez

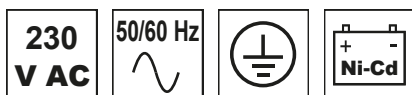

TRACON	[h]	V	Ah		[W]
INV-DL-6	0.5 h	6 V	1.800 mAh	–	6-18 W
INV-DL-15	0.5 h	19.2 V	1.500 mAh	220 × 105 × 55 mm	18-50 W



Fényerő-szabályozható meghajtó a LED-DL... panelekhez

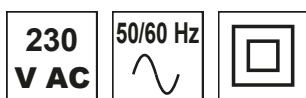

TRACON			$\eta\%$		
DLDD12W	230 VAC; 0,14 A	30-40 VDC; 300 mA	>85 %	Triac 3-100%	115 × 43 × 25 mm
DLDD18W	230 VAC; 0,21 A	30-40 VDC; 300 mA	>85 %	Triac 3-100%	115 × 43 × 25 mm



Kerek, beépíthető LED panel fokozott védelemmel

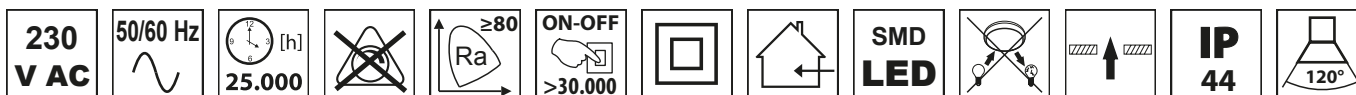

TRACON	[W]		[lm]	T_c [K]		D × H (mm)	
LED-DLV-6NW	6 W	1 × 13 W	390 lm	4.000 K	105 mm	115 × 32	A
LED-DLV-12NW	12 W	1 × 26 W	840 lm	4.000 K	155 mm	170 × 32	A
LED-DLV-18NW	18 W	2 × 26 W	1.450 lm	4.000 K	205 mm	220 × 32	A

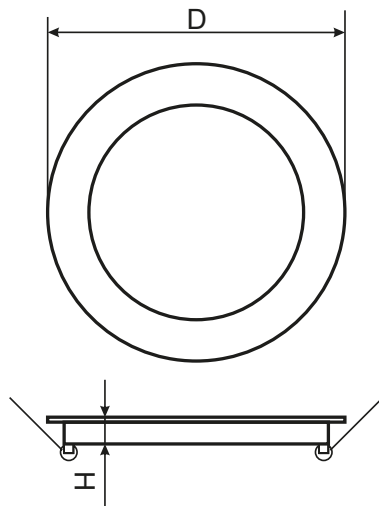

A lámpatestek a hálózati működtetéshez szükséges meghajtó egységeket és a LED fényforrásokat egyaránt tartalmazzák.

Kerek, beépíthető LED panel

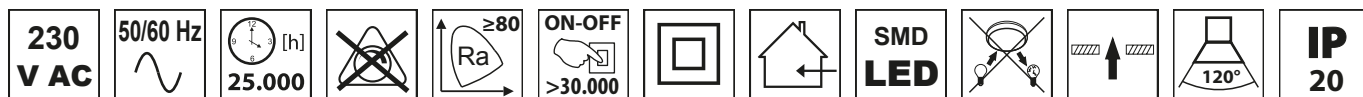

TRACON						D x H (mm)	
LED-DLS-3NW	3 W	1 x 13 W	240 lm	4.000 K	70 mm	90 x 25	A+
LED-DLS-6NW	6 W	1 x 13 W	480 lm	4.000 K	100 mm	120 x 25	A+
LED-DLS-9NW	9 W	1 x 26 W	720 lm	4.000 K	125 mm	150 x 25	A+
LED-DLS-12NW	12 W	1 x 26 W	960 lm	4.000 K	155 mm	170 x 25	A+
LED-DLS-18NW	18 W	2 x 26 W	1.440 lm	4.000 K	205 mm	225 x 25	A
LED-DLS-24NW	24 W	3 x 26 W	1.920 lm	4.000 K	205 mm	225 x 25	A



A lámpatestek a hálózati működtetéshez szükséges meghajtó egységeket és a LED fényforrásokat egyaránt tartalmazzák.

Négyzet alakú, beépíthető LED panel SAMSUNG chippel

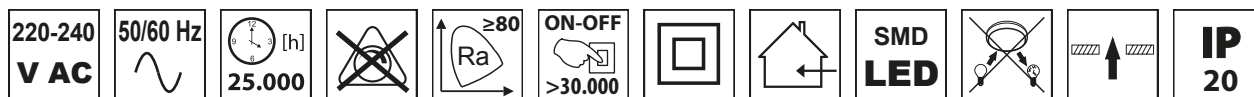

TRACON						D x H (mm)	
LED-DLNS-3NW	3 W	1 x 13 W	240 lm	4.000 K	70 x 70 mm	86 x 25	A+
LED-DLNS-6NW	6 W	1 x 13 W	480 lm	4.000 K	100 x 100 mm	120 x 25	A+
LED-DLNS-9NW	9 W	1 x 26 W	720 lm	4.000 K	125 x 125 mm	150 x 25	A+
LED-DLNS-12NW	12 W	1 x 26 W	960 lm	4.000 K	150 x 150 mm	170 x 25	A+
LED-DLNS-18NW	18 W	2 x 26 W	1.440 lm	4.000 K	205 x 205 mm	225 x 25	A
LED-DLNS-24NW	24 W	3 x 26 W	1.920 lm	4.000 K	205 x 205 mm	225 x 25	A



A lámpatestek a hálózati működtetéshez szükséges meghajtó egységeket és a LED fényforrásokat egyaránt tartalmazzák.

Védett, beépíthető LED mélysugárzó, kerek

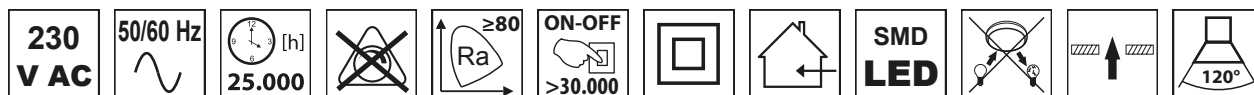

TRACON						D x H (mm)	
LED-DLIP-6NW	6 W	1 x 13 W	420 lm	4.000 K	55 mm	75 x 20	A+
LED-DLIP-10NW	10 W	1 x 26 W	800 lm	4.000 K	105 mm	125 x 20	A+
LED-DLIP-20NW	20 W	2 x 26 W	1.620 lm	4.000 K	165 mm	185 x 20	A+
LED-DLIP-28NW	28 W	3 x 26 W	2.250 lm	4.000 K	195 mm	215 x 20	A+

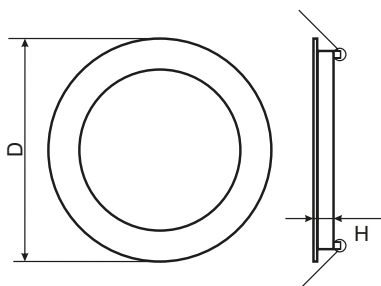

A lámpatestek a hálózati működtetéshez szükséges meghajtó egységeket és a LED fényforrásokat egyaránt tartalmazzák.

Védett, beépíthető LED mélysugárzó, négyzetes

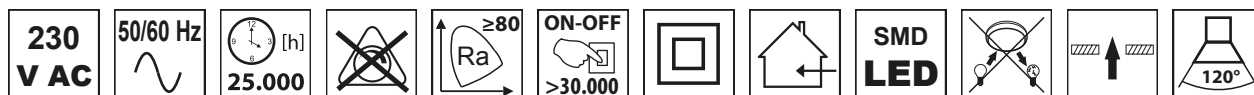

TRACON						L x W x H (mm)	
LED-DLNIP-6NW	6 W	1 x 13 W	450 lm	4.000 K	55 x 55 mm	75 x 75 x 20	A+
LED-DLNIP-10NW	10 W	1 x 26 W	920 lm	4.000 K	105 x 105 mm	125 x 125 x 20	A+
LED-DLNIP-20NW	20 W	2 x 26 W	1.645 lm	4.000 K	165 x 165 mm	185 x 185 x 20	A+
LED-DLNIP-28NW	28 W	3 x 26 W	2.340 lm	4.000 K	195 x 195 mm	215 x 215 x 20	A+

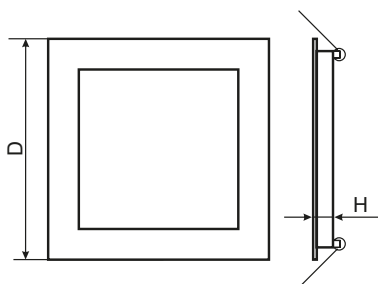

A lámpatestek a hálózati működtetéshez szükséges meghajtó egységeket és a LED fényforrásokat egyaránt tartalmazzák.

Kompakt beépíthető LED mélysugárzó

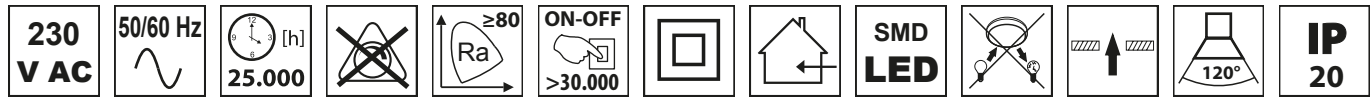

TRACON						D x H (mm)	
DLC2,5NW	2,5 W	1 x 13 W	220 lm	4.000 K	67 mm	92 x 40	A+
DLC5NW	5 W	1 x 13 W	450 lm	4.000 K	75 mm	104 x 40	A+
DLC12NW	12 W	1 x 26 W	1.050 lm	4.000 K	115 mm	148 x 50	A+
DLC24NW	24 W	2 x 26 W	2.100 lm	4.000 K	185 mm	225 x 50	A+

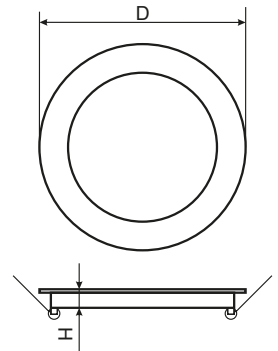
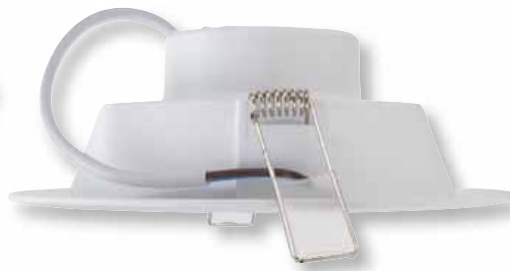

A lámpatestek a hálózati működtetéshez szükséges meghajtó egységeket és a LED fényforrásokat egyaránt tartalmazzák.

LED mélysugárzó változtatható színhőmérséklettel

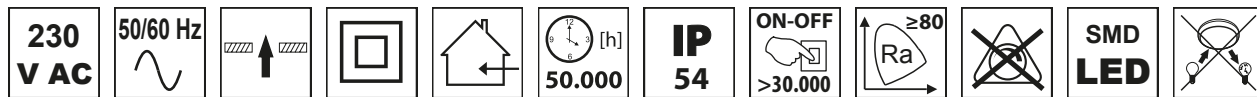

TRACON							D x H (mm)	
DLTRIO25W	25 W	2 x 32 W	2.280/2.650/2.450 lm	3.000/4.000/5.700 K	90°	205 mm	228 x 98	A

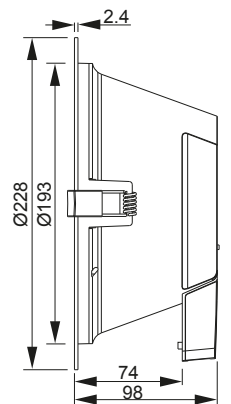
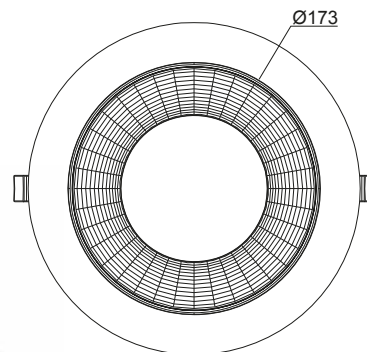

A lámpatestek a hálózati működtetéshez szükséges meghajtó egységeket és a LED fényforrásokat egyaránt tartalmazzák.

Süllyesztett lámpatestek spot fényforrásokhoz

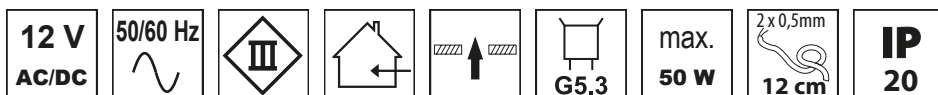

TRACON			
FIX	30°		
TLC-2C	TLC-6C		A++, A+, A, B, C, D, E
TLC-2MC	TLC-6MC		A++, A+, A, B, C, D, E
TLC-2MG	TLC-6MG		A++, A+, A, B, C, D, E
TLC-2MR	TLC-6MR		A++, A+, A, B, C, D, E
TLC-2W	TLC-6W		A++, A+, A, B, C, D, E

Megjegyzés: 230 V-os, GU10 foglalattal rendelkező fényforrásokhoz TAGU-10 foglalatot szükséges még rendelni, lásd E/107. oldal!

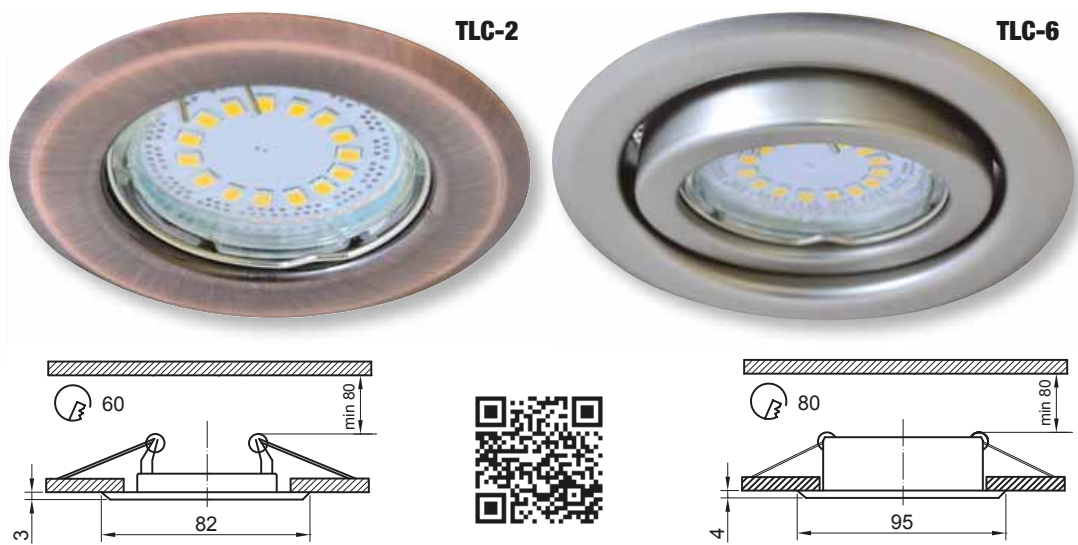
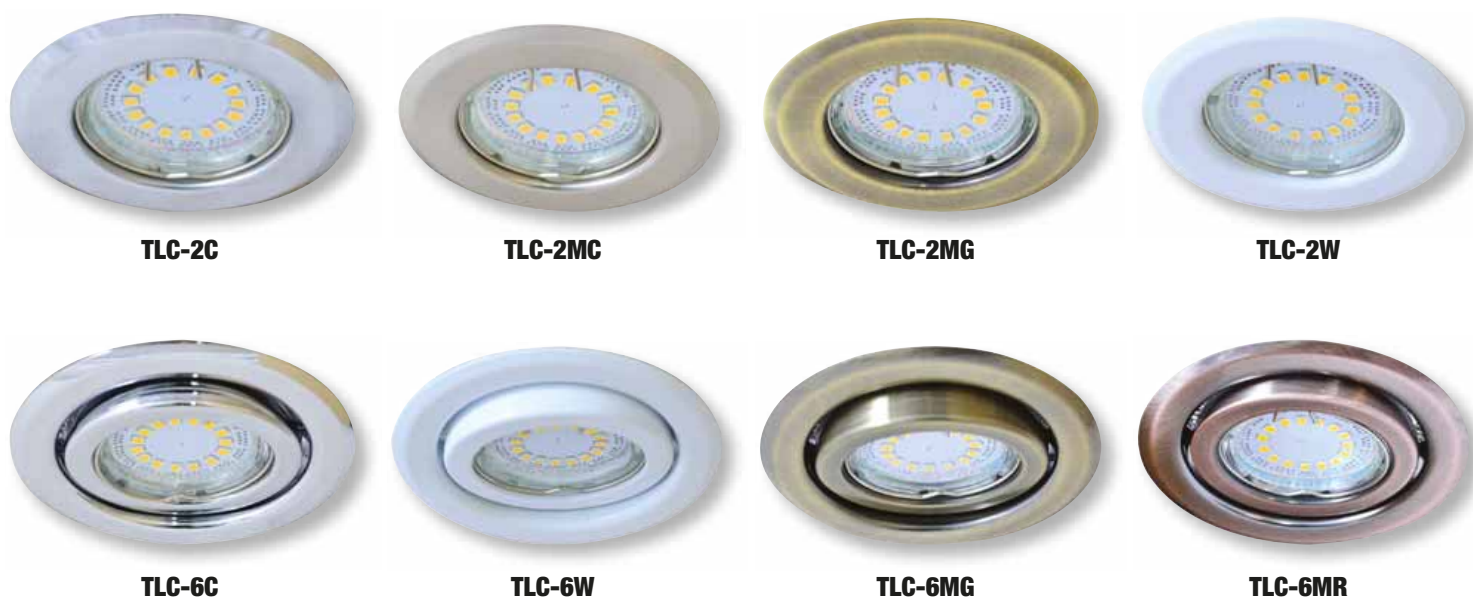

OLVASSA BE A KÓDOT!

- Nézze meg újdonságainkat
- Legyen naprakész

Kínálatunk gyorsan és folyamatosan fejlődik!
Katalógusunk a 2021. áprilisi állapotot tükrözi.
Naprakész információért látogasson el honlapunkra!

LED mélysugárzó, forgatható

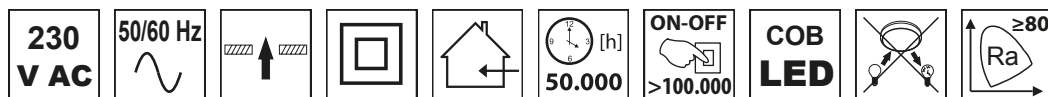

TRACON			LED		Tc [K]			D × H (mm)	IP..	
DLCOBA10W	10 W	20 W	800 lm	4.000 K	24°	87 mm	96 × 68		IP 40	A+
DLCOBA35W	35 W	70 W	3.500 lm	4.000 K	60°	165 mm	180 × 100		IP 40	A+
DLCOBA35WW	35 W	70 W	3.250 lm	2.700 K	60°	165 mm	180 × 100		IP 40	A+
DLCOBD5W*	5 W	10 W	510 lm	4.000 K	60°	68 mm	80 × 30		IP 65	A+
DLCOBD13W*	13 W	26 W	1.210 lm	4.000 K	60°	90 mm	110 × 49,5		IP 65	A+
DLNCOBD5W*	5 W	10 W	510 lm	4.000 K	60°	68 mm	80 × 30		IP 65	A+
DLNCOBD13W*	13 W	26 W	1.210 lm	4.000 K	60°	90 mm	110 × 49,5		IP 65	A+

* dimmelhető

A lámpatestek a hálózati működtetéshez szükséges meghajtó egységeket és a LED fényforrásokat egyaránt tartalmazzák.



DLCOBA..



DLNCOBD..

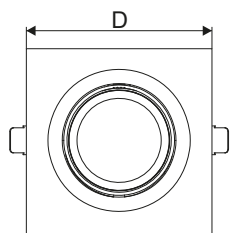
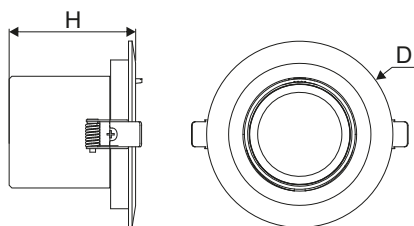

DLCOBD..



OLVASSA BE A KÓDOT!

- Nézze meg újdonságainkat
- Legyen naprakész

Kínálatunk gyorsan és folyamatosan fejlődik!
Katalógusunk a 2021. áprilisi állapotot tükrözi.

Naprakész információért
látogasson el honlapunkra!

LED panel, LPM széria



TRACON						
	W	4 × 18 W	lm	Tc [K]	D × W × H (mm)	
LPM606040NW	40 W	4 × 18 W	3.400 lm	4.000 K	595 × 595 × 9	A
LPM606040WW	40 W	4 × 18 W	3.300 lm	2.700 K	595 × 595 × 9	A
LPM606050NW	48 W	4 × 18 W	4.200 lm	4.000 K	595 × 595 × 9	A
LPM606050WW	48 W	4 × 18 W	4.100 lm	2.700 K	595 × 595 × 9	A
LPM3012040NW	40 W	2 × 36 W	3.400 lm	4.000 K	1195 × 295 × 9	A
LPM3012040WW	40 W	2 × 36 W	3.300 lm	2.700 K	1195 × 295 × 9	A

A négyzetes formájú LED paneleket az álmennyezettel szerelt közforgalmú helyiségek, irodák, műhelyek megvilágításához ajánljuk süllyesztett szereléssel.

A 600 × 600 mm-es panel pontosan egy raszter méretű, így a 4 × 18 W-os fénycsöves lámpatestek helyettesítésére alkalmasak.

A 300 × 1200 mm-es panel fél raszter széles és két raszter hosszú, pontosan a 2 × 36 W-os fénycsöves lámpatestek méreteivel egyeznek meg, elsősorban folyosók megvilágításához ideálisak.

Az **INV-DL-15** egységgel kiegészítve a panelek opcionálisan vészvilágítóként is üzemeltethetők.

Projektekhez opcionálisan mennyezeti és függesztett szereléshez szükséges készletek is elérhetők, valamint eltérő műszaki adatokkal rendelkező (eltérő teljesítmény, színhőmérséklet, teljesítmény, keretszín, méret, fényerőszabályzás) kivitelek is megrendelhetők.



A lámpatestek a hálózati működtetéshez szükséges vibrációmentes meghajtó egységeket és a LED fényforrásokat egyaránt tartalmazzák.

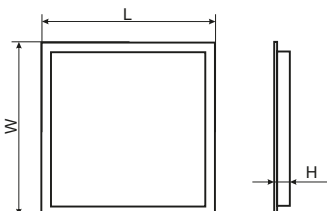

Keret és hátfal: alumínium
Előlap: polikarbonát
A panel keretének színe: fehér

ÉLVILÁGÍTÁSSAL

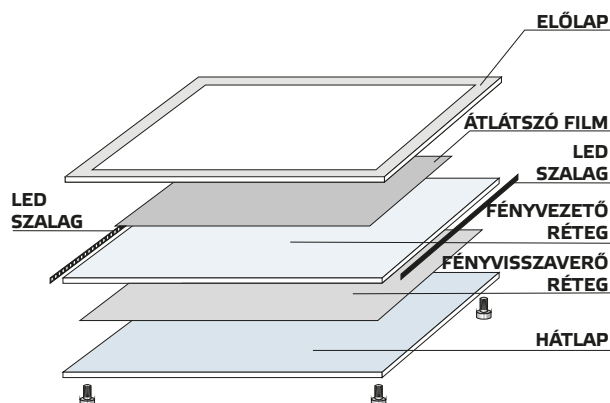

Az LPM paneleknél a ledok az alumínium keret oldalában, a világítási felületre merőlegesen vannak elhelyezve és a fényelosztató réteget oldalról világítják meg. Ez a réteg a hátlapi fényvisszaverő és az előlapi fényáteresztő réteggel együtt biztosítja a fény egyenletes eloszlását.



LED panel, LPH széria

220-240 V AC	50/60 Hz	50.000 [h]	$Ra \geq 80$	ON-OFF >100.000			SMD LED				IP 40	UGR 21
------------------------	----------	------------	--------------	--------------------	--	--	----------------	--	--	--	--------------	---------------

TRACON					D x W x H (mm)	
LPH606040NW	40 W	4 x 18 W	3.300 lm	4.000 K	595 x 595 x 30	A
LPH606050NW	48 W	4 x 18 W	3.900 lm	4.000 K	595 x 595 x 30	A
LPH3012040NW	40 W	2 x 36 W	3.300 lm	4.000 K	1195 x 295 x 30	A

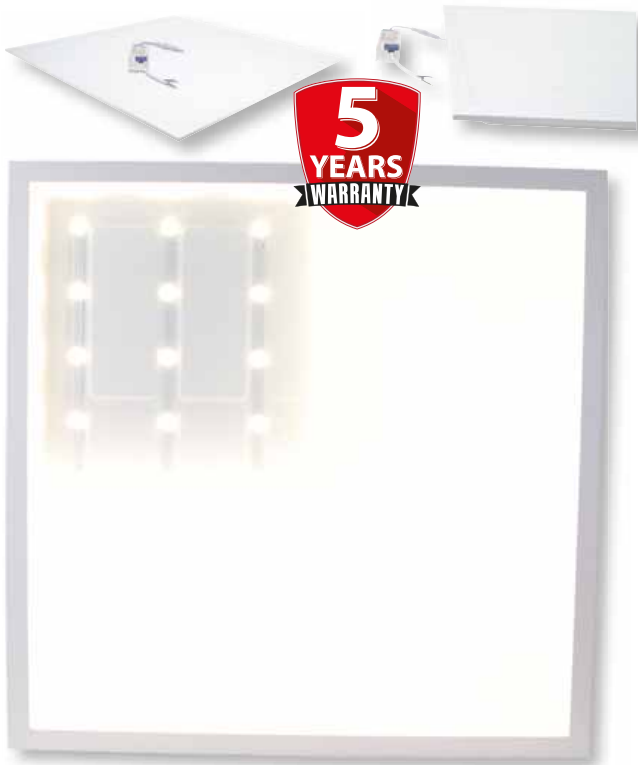

Az LPH típusú panelek-nél a ledek a hátlapon helyezkednek el az előlappal párhuzamosan. Itt az egyenletes fényeloszlást a ledek mélyebb elhelyezése és az opál előlap biztosítják.



HÁTSÓ MEGVILÁGÍTÁSSAL

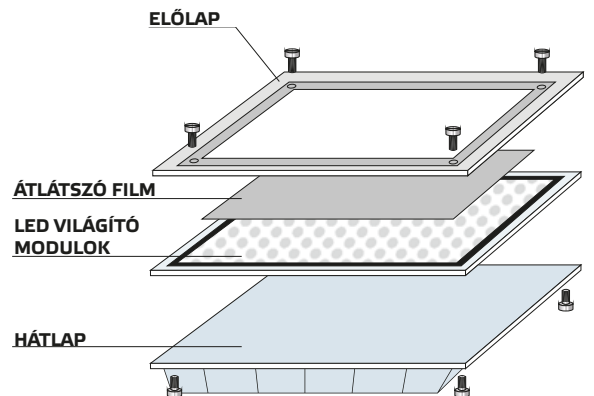

A lámpatestek a hálózati működtetéshez szükséges vibrációmentes meghajtó egységeket és a LED fényforrásokat egyaránt tartalmazzák.

Meghajtó LPM és LPH panelekhez

50/60 Hz		IP 20		
----------	--	--------------	--	--

TRACON			$\eta\%$	
LPD40W	230 VAC, 0.3 A	25-40 VDC, 1000 mA	>89 %	114 x 43 x 29 mm
LPD50W	230 VAC, 0.3 A	24-45 VDC, 1000 mA	>89 %	131 x 38 x 25 mm



LPD40W



LPD50W



Szerelőkeret LED panelekhez

TRACON



600 x 600

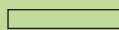

300 x 1.200

LP6060K

LPM6060...

LP30120K

LPM30120...

A kiegészítő szerelőkeretek segítségével a LED panelek elhelyezése falon kívüli szereléssel is lehetővé válik. A panel és a szerelési felület között maximum 32 mm magas meghajtók helyezhetők el.

A keret anyaga: alumínium, színe fehér.

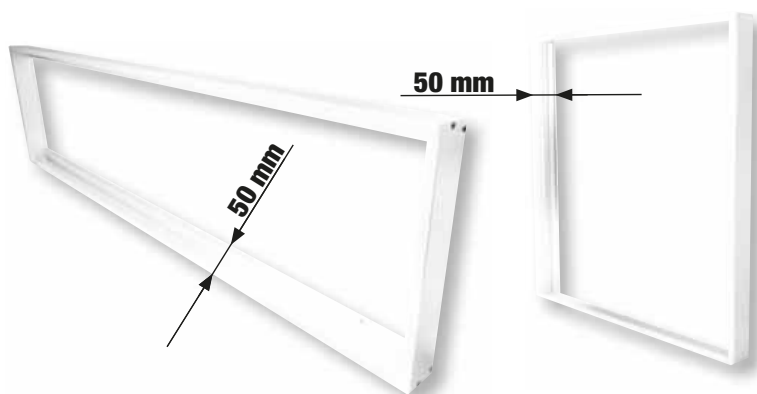

Függesztő készlet LED panelekhez

TRACON



600 x 600



300 x 1.200

LP606040F

LPM..., LPH....

1,5 m hosszú, állítható.

Extra magas álmennyezetek esetén maximum 1,5 méterrel lejjebb hozható a panel, nem kell az egész álmennyezetet átépíteni!

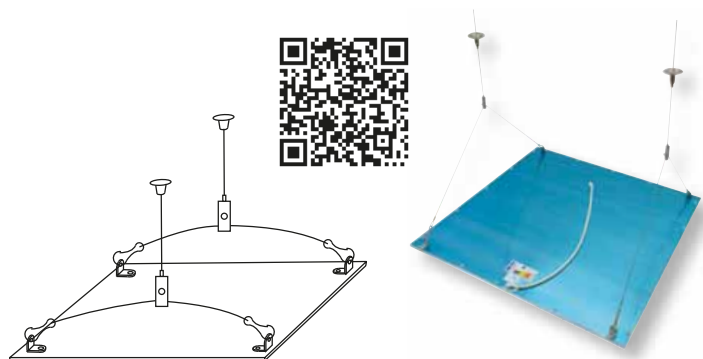

Fényerő-szabályozható meghajtó

TRACON



$\eta\%$



LPCC40WD

200-240 VAC, 0,27 A

27-45 VDC, 950 mA

>90 %

Triac, 8-100 %

LPCC48WD

200-240 VAC, 0,6 A

26-40 VDC, 1100 mA

>90 %

Triac, 10-100 %

LPCC40W110D

100-240 VAC, 0,5 A

24-38 VDC, 1050 mA

>90 %

1-10 V, 8-100 %

LPCC48W110D

200-240 VAC, 0,5 A

26-42 VDC, 1100 mA

>90 %

1-10 V, 8-100 %

A fényerő-szabályozható meghajtók használatával a LED panelek megfelelő külső szabályozó szerelvények (Triac, 1-10 V) segítségével fényerő-szabályozhatóvá tehetők.



LPCC40W110D



Rögzítő fül LED panelek süllyesztett szereléséhez

TRACON



600 x 600

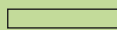

300 x 1.200

LPC

× 4

× 6

1 csomag 4 fület tartalmaz.



Kerek LED fali világítóttest, LED-DLF széria

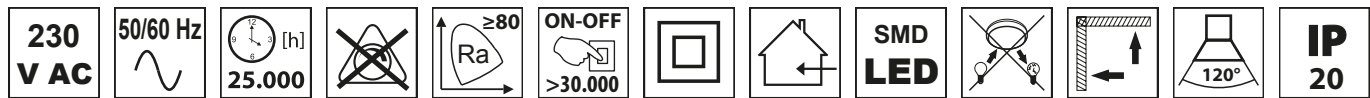

TRACON					D × H (mm)	Ei
LED-DLF-6NW	6 W	1 × 13 W	330 lm	4.000 K	120 × 39	A
LED-DLF-12NW	12 W	1 × 26 W	800 lm	4.000 K	175 × 39	A
LED-DLF-18NW	18 W	2 × 26 W	1.200 lm	4.000 K	220 × 39	A
LED-DLF-18WW	18 W	2 × 26 W	1.200 lm	2.700 K	220 × 39	A
LED-DLF-28NW	28 W	3 × 26 W	1.800 lm	4.000 K	300 × 39	A
LED-DLF-28WW	28 W	3 × 26 W	1.800 lm	2.700 K	300 × 39	A

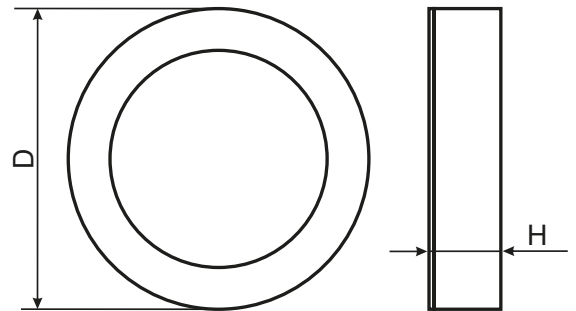

A lámpatestek a hálózati működtetéshez szükséges meghajtó egységeket és a LED fényforrásokat egyaránt tartalmazzák.

Négyzet alakú LED fali világítóttest, LED-DLNF széria

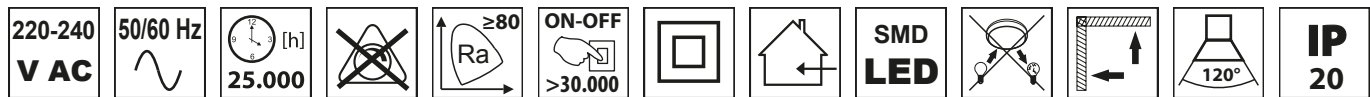

TRACON					D × H (mm)	Ei
LED-DLNF-6NW	6 W	1 × 13 W	350 lm	4.000 K	120 × 39	A
LED-DLNF-12NW	12 W	1 × 26 W	800 lm	4.000 K	170 × 39	A
LED-DLNF-18NW	18 W	2 × 26 W	1.200 lm	4.000 K	225 × 39	A
LED-DLNF-28NW	28 W	3 × 26 W	1.900 lm	4.000 K	295 × 39	A

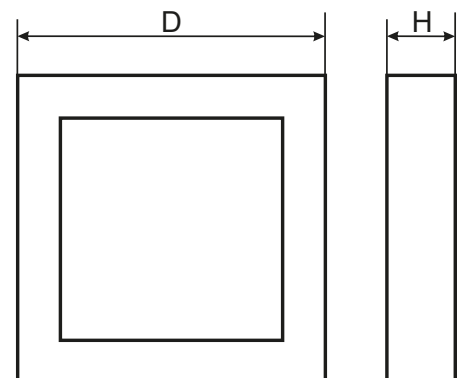

A lámpatestek a hálózati működtetéshez szükséges meghajtó egységeket és a LED fényforrásokat egyaránt tartalmazzák.

Kerek LED fali világítóttest, LED-DLF széria, SAMSUNG chippel

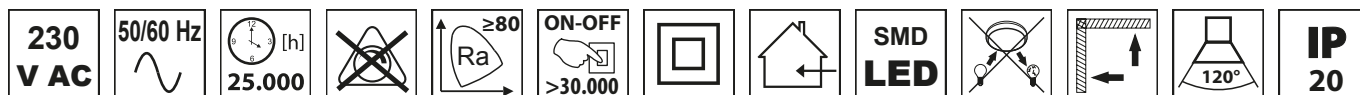

TRACON						
LED-DLFS-6NW	6 W	1 × 13 W	480 lm	4.000 K	120 × 28	A+
LED-DLFS-12NW	12 W	1 × 26 W	960 lm	4.000 K	170 × 28	A+
LED-DLFS-18NW	18 W	2 × 26 W	1.440 lm	4.000 K	225 × 28	A
LED-DLFS-24NW	24 W	3 × 26 W	1.920 lm	4.000 K	225 × 28	A

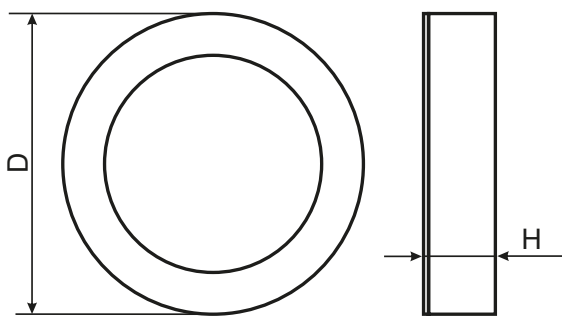

SAMSUNG LED Inside



A lámpatestek a hálózati működtetéshez szükséges meghajtó egységeket és a LED fényforrásokat egyaránt tartalmazzák.



Négyzet alakú LED fali világítóttest, LED-DLNF széria

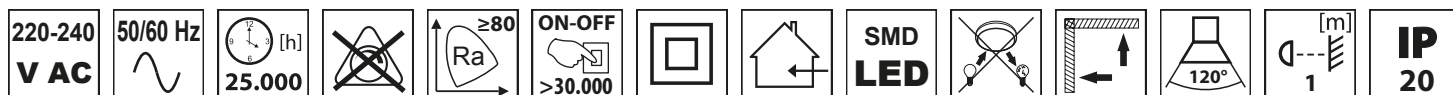

TRACON						
LED-DLNFS-6NW	6 W	1 × 13 W	480 lm	4.000 K	120 × 28	A+
LED-DLNFS-12NW	12 W	1 × 26 W	960 lm	4.000 K	170 × 28	A+
LED-DLNFS-18NW	18 W	2 × 26 W	1.440 lm	4.000 K	225 × 28	A
LED-DLNFS-24NW	24 W	3 × 26 W	1.920 lm	4.000 K	225 × 28	A

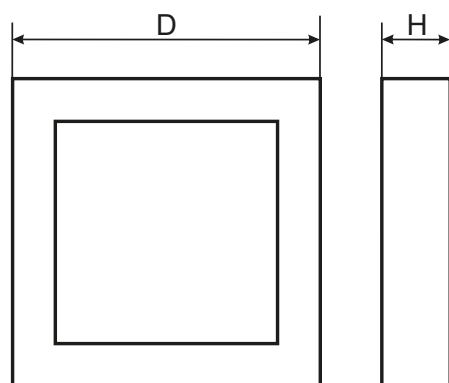

SAMSUNG LED Inside



A lámpatestek a hálózati működtetéshez szükséges meghajtó egységeket és a LED fényforrásokat egyaránt tartalmazzák.



Kerek LED fali világítótest, MFDS széria

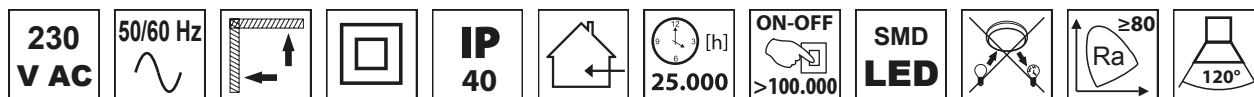

TRACON						
	W	W	[lm]	[K]	D × H (mm)	
MFDS8W	8 W	75 W	600 lm	3.000 K	102 × 28	A
MFDS16W	16 W	150 W	1.200 lm	3.000 K	205 × 34	A



A lámpatestek a hálózati működtetéshez szükséges meghajtó egységeket és a LED fényforrásokat egyaránt tartalmazzák.

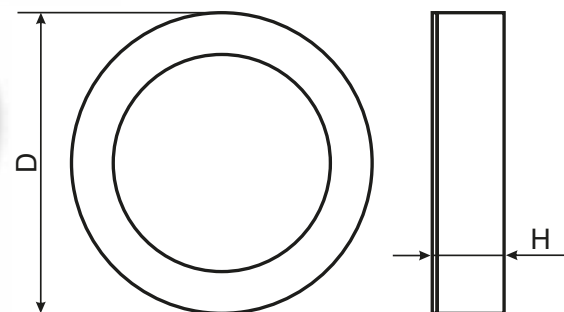

Kerek LED fali világítótest, MFU széria

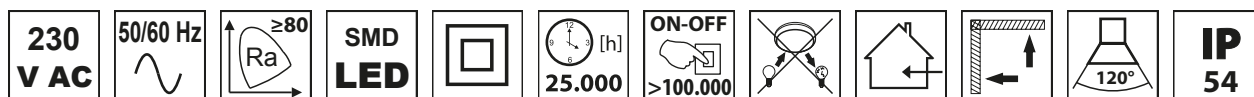

TRACON						
	W	W	[lm]	[K]	D × H (mm)	
MFU30NW	30 W	250 W	2.750 lm	4.000 K	400 × 63	A+

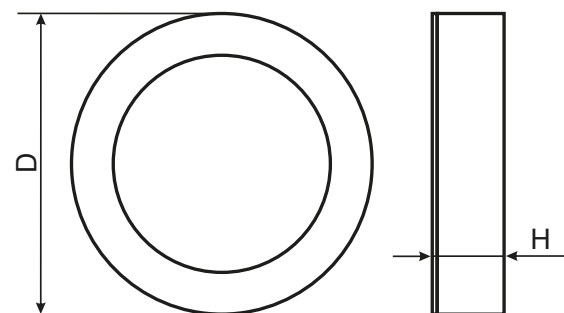

A lámpatestek a hálózati működtetéshez szükséges meghajtó egységeket és a LED fényforrásokat egyaránt tartalmazzák.



Fényerő-szabályozható LED világítótest

230 V AC	50/60 Hz	Ra ≥80	SMD LED			50.000 [h]	ON-OFF >100.000				IP 40
----------	----------	--------	---------	--	--	------------	-----------------	--	--	--	-------

TRACON				Tc [K]		D x H (mm)	
GLOMD25NW	25 W	150 W	1.900 lm	4.000 K	120°	298 x 50	A+

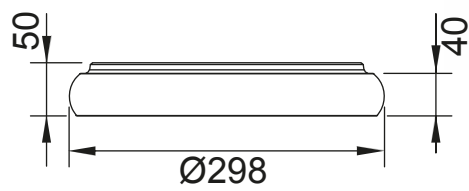

Fényerő-szabályozható LED világítótest, függeszthető

230 V AC	50/60 Hz	Ra ≥80	SMD LED			50.000 [h]	ON-OFF >100.000				IP 40
----------	----------	--------	---------	--	--	------------	-----------------	--	--	--	-------

TRACON				Tc [K]		D x H (mm)	
GLOFD25NW	25 W	150 W	1.900 lm	4.000 K	120°	298 x 50 / 1085	A+

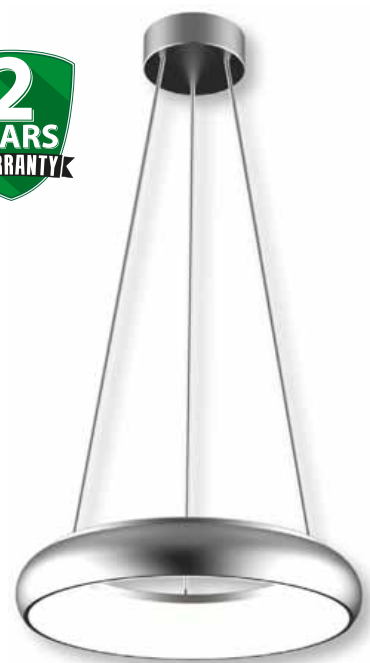
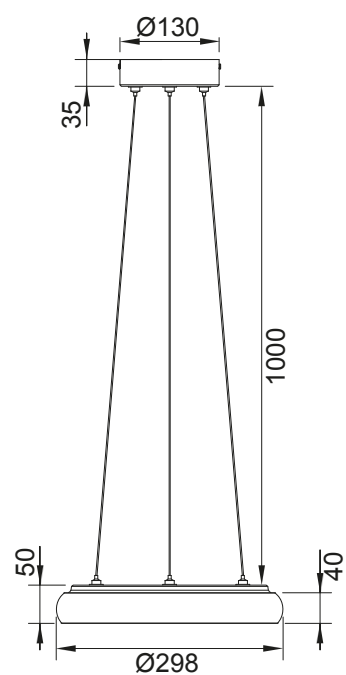

Kerek LED fali világítótest állítható színhőmérséklettel

230 V AC	50/60 Hz	Ra ≥80	SMD LED				ON-OFF >100.000				IP 54
----------	----------	--------	---------	--	--	--	-----------------	--	--	--	-------

TRACON				Tc [K]		D × H (mm)	
DLFTRIO18W	18 W	150 W	1.440/1.670/1.530 lm	3.000/4.000/5.700 K	90°	170 × 124	A+
DLFTRIO25W	25 W	200 W	2.180/2.530/2.340 lm	3.000/4.000/5.700 K	90°	213 × 129	A+

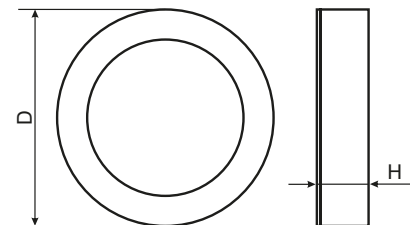

LUF0 fényerő-szabályozható mennyezeti világítótest (3000/4000/5700K)

230 V AC	50/60 Hz	ON-OFF >100.000					SMD LED		Ra ≥80		IP 65
----------	----------	-----------------	--	--	--	--	---------	--	--------	--	-------

TRACON				Tc [K]		D × H (mm)	
LUFOD12W	12 W	100 W	1.110/1.220/1.190 lm	3.000/4.000/5.700 K	120°	270 × 74	A+
LUFOD18W	18 W	150 W	1.750/1.870/1.782 lm	3.000/4.000/5.700 K	120°	320 × 74	A+
LUFOD25W	25 W	200 W	2.450/2.600/2.500 lm	3.000/4.000/5.700 K	120°	320 × 74	A+

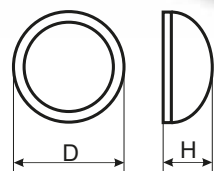

Fali lámpatest, ívelt forma



TRACON							
	[W]		[lm]	[K]	L × W × H D × H (mm)		
SLI10W	10 W		800 lm	4.500 K	250 × 66 × 188		A
SLI15W	15 W		1.100 lm	4.500 K	250 × 66 × 188		A
SLIA10W	10 W		800 lm	4.500 K	250 × 66 × 188		A
SLIA15W	15 W		1.100 lm	4.500 K	250 × 66 × 188		A
SLIB15W	15 W		1.100 lm	4.500 K	250 × 66 × 188		A
SLIBA15W	15 W	BASIC	1.100 lm	4.500 K	250 × 66 × 188		A
SLK10W	10 W		800 lm	4.500 K	210 × 49		A
SLK15W	15 W		1.100 lm	4.500 K	210 × 49		A

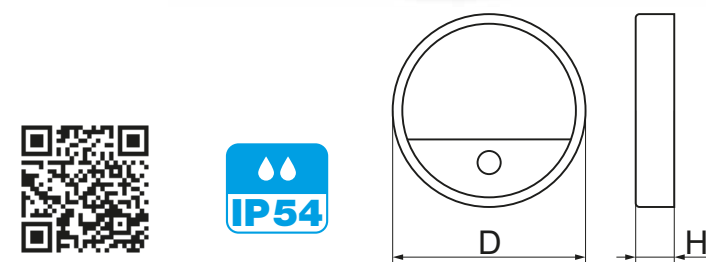
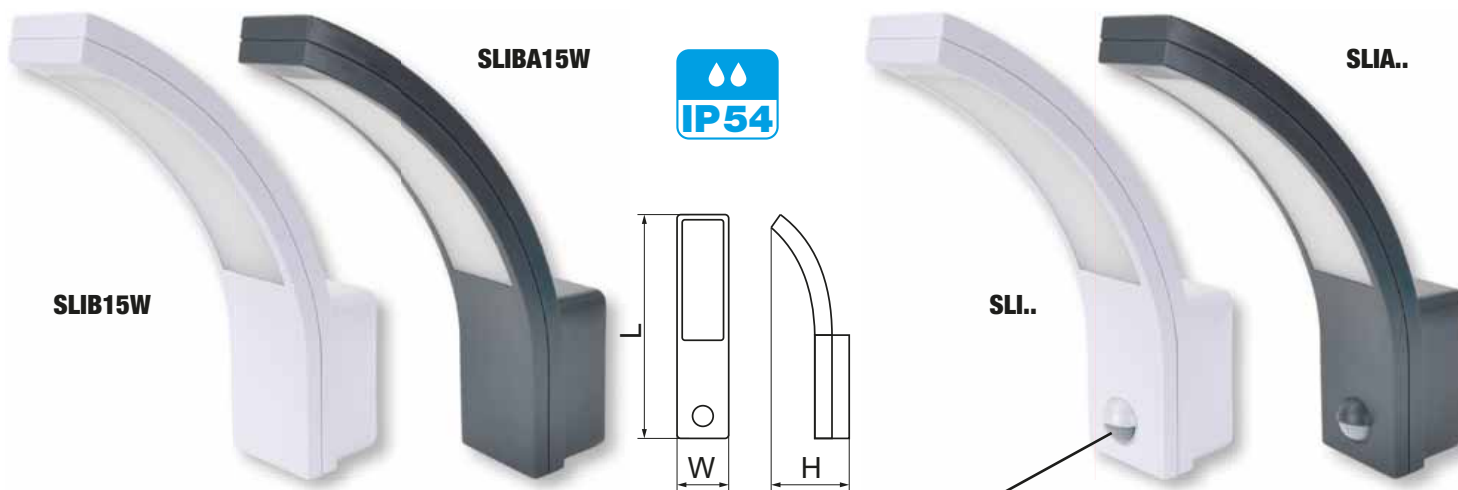

LED fali világítóttest, MF széria (csillagfény effektel)



TRACON					D × H (mm)	
MF12NW	12 W	75 W	750 lm	4.000 K	260 × 90	A
MF18NW	18 W	100 W	1.100 lm	4.000 K	330 × 100	A
MF24NW	24 W	200 W	1.600 lm	4.000 K	385 × 110	A
MF40NW	40 W	300 W	2.700 lm	4.000 K	500 × 115	A
MF60NW	60 W	400 W	4.000 lm	4.000 K	500 × 115	A

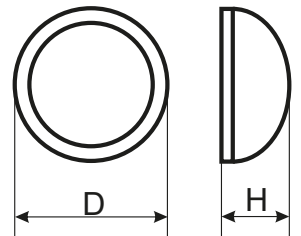

LED fali világítóttest, MFS széria



TRACON					D × H (mm)	
MFS12NW	12 W	75 W	750 lm	4.000 K	260 × 80	A
MFS18NW	18 W	100 W	1.100 lm	4.000 K	330 × 95	A
MFS24NW	24 W	200 W	1.600 lm	4.000 K	380 × 105	A
MFS40NW	40 W	300 W	2.700 lm	4.000 K	500 × 115	A
MFS60NW	60 W	400 W	4.000 lm	4.000 K	500 × 115	A

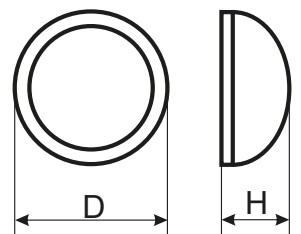

Design lámpa SKY széria (csillagfény effekttel)



TRACON							
SKY24NW	24 W	200 W	1.320 lm	4.000 K	430 × 80	–	A
SKYR40W	40 W	300 W	2.200 lm	3.000 - 6.500 K	530 × 90	✓	A
SKYR60W	60 W	400 W	3.300 lm	3.000 - 6.500 K	530 × 90	✓	A

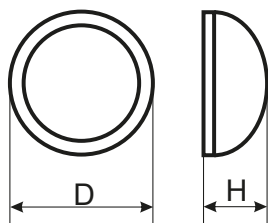

LED fali világítóttest, MFR széria (csillagfény effekttel) vezérelhető



TRACON							
MFR60W	60 W	400 W	4.200 lm	3.000 - 6.500 K	480 × 110		A
MFR80W	80 W	500 W	5.700 lm	3.000 - 6.500 K	760 × 115		A
MFR100W	100 W	700 W	7.000 lm	3.000 - 6.500 K	800 × 115		A

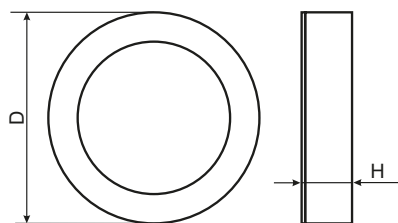

Műanyag búrás falon kívüli LED lámpatest fokozott védelemmel

220-240 V AC 50/60 Hz ON-OFF >30.000 30.000 Ra ≥80 SMD LED IK08 IP 54

TRACON		LED	LED	LED	Tc [K]	D × H (mm)	[h]	Ei
ADAM12W	BASIC	12 W	70×SMD2835	1.200 lm	3000/4000/6500 K	320 × 82,5	-	A+
ADAM16W		16 W	91×SMD2835	1.600 lm	3000/4000/6500 K	320 × 82,5	-	A+
ADAMS12W		12 W	70×SMD2835	1.200 lm	3000/4000/6500 K	320 × 82,5	-	A+
ADAMS16W		16 W	91×SMD2835	1.600 lm	3000/4000/6500 K	320 × 82,5	-	A+
ADAME13W		13 W/2 W	74×SMD2835	1.200 lm/140 lm	3000/4000/6500 K	320 × 82,5	1 h	A+
ADAME17W		17 W/2 W	95×SMD2835	1.600 lm/140 lm	3000/4000/6500 K	320 × 82,5	1 h	A+
ADAMSE13W		13 W/2 W	74×SMD2835	1.200 lm/140 lm	3000/4000/6500 K	320 × 82,5	1 h	A+
ADAMSE17W		17 W/2 W	95×SMD2835	1.600 lm/140 lm	3000/4000/6500 K	320 × 82,5	1 h	A+



ADAMSE

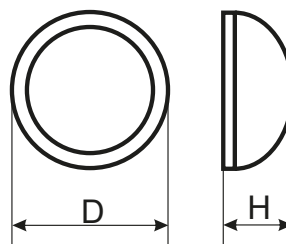
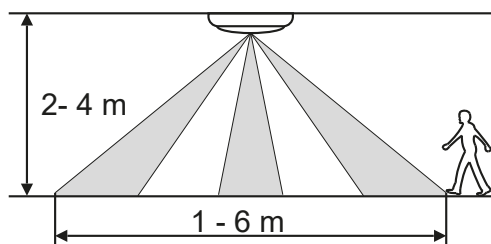
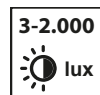

ADAM..



3000 K



4000 K



6500K

LED fali világítótest, EVA széria



TRACON								
EVA14NW	14 W		72 × SMD2835	1.000 lm	4.000 K	305 × 84	–	A
EVA21NW	21 W	BASIC	108 × SMD2835	1.600 lm	4.000 K	400 × 96	–	A
EVA28NW	28 W		144 × SMD2835	2.100 lm	4.000 K	400 × 96	–	A
EVAS14NW	14 W		72 × SMD2835	1.000 lm	4.000 K	305 × 84	–	A
EVAS21NW	21 W		108 × SMD2835	1.600 lm	4.000 K	400 × 96	–	A
EVAS28NW	28 W		144 × SMD2835	2.100 lm	4.000 K	400 × 96	–	A
EVAE14NW	14 W / 2 W		72 × SMD2835	1.000/140 lm	4.000 K	305 × 84	1 h	A
EVAE21NW	21 W / 2 W		108 × SMD2835	1.600/140 lm	4.000 K	400 × 96	1 h	A
EVAE28NW	28 W / 2 W		144 × SMD2835	2.100/140 lm	4.000 K	400 × 96	1 h	A



EVA..

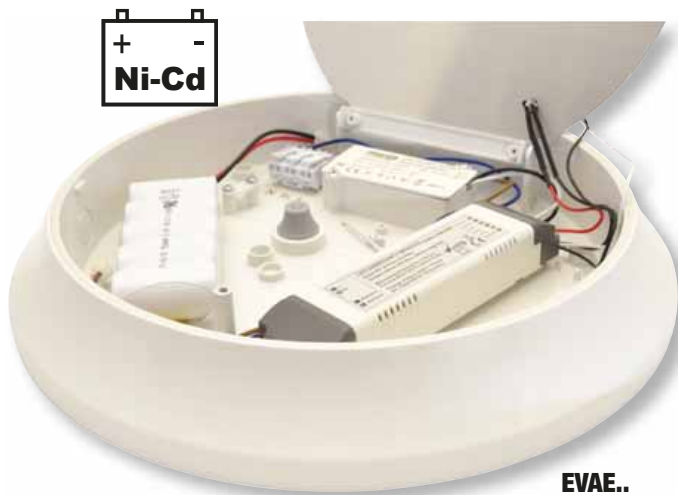

EVAE..

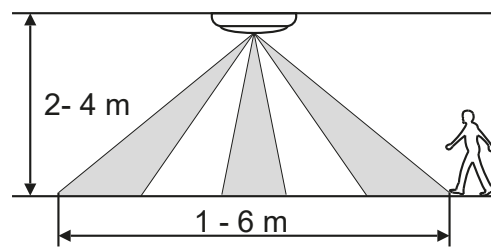

EVAS..

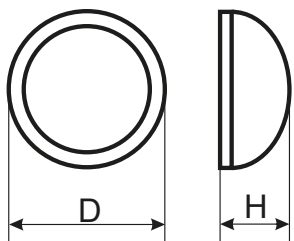

LED fali világítóttest, LFEK széria

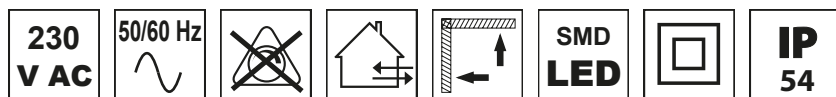

TRACON					D × H (mm)	Tc [K]	
LFEK6NW	6 W	60 W	420 lm	16 × SMD5028	170 × 45	4.000 K	A
LFEK12NW	12 W	100 W	840 lm	32 × SMD5028	230 × 45	4.000 K	A
LFEK18NW	18 W	150 W	1.500 lm	48 × SMD5028	230 × 45	4.000 K	A+

RELEVANT STANDARD
EN 60598

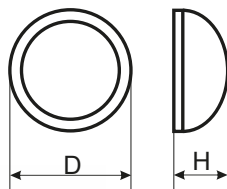

LED fali világítóttest, MFM széria (mozgásérzékelővel)

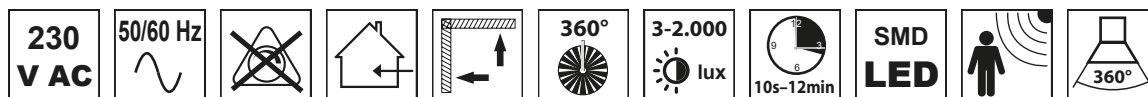

TRACON					D × H (mm)	IP..	
MFM01	1 × E27	max. 1 × 25 W	–	–	270 × 103	IP 20	A++, A+, A, B, C, D, E
MFM02	–	16 W	1.285 lm	81 × SMD5028	300 × 112	IP 44	A



MFM02



MFM01

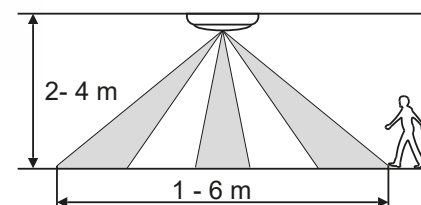
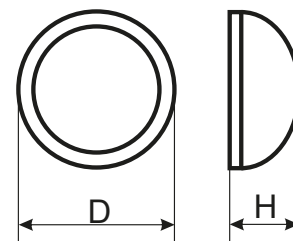

Üvegburás fal- és mennyezeti lámpatestek (UFO lámpák)

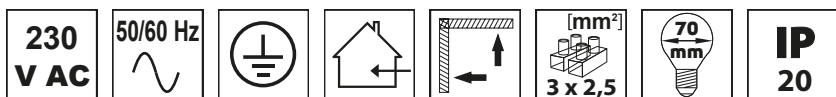

TRACON			D (mm)		Ei
UFO-1-B					
UFO-1-F	1 x 60 W	1 x E27			
UFO-1-K					
UFO-1-Z					
UFO-2-B					
UFO-2-F	2 x 60 W	2 x E27	∅ 300		A++, A+, A, B, C, D, E
UFO-2-K					
UFO-2-Z					
UFO-F-B					
UFO-F-F	1 x 60 W	1 x E27			
UFO-F-K					
UFO-F-Z					



Kézzel nyitható védett fali lámpatest („hajó lámpa”)

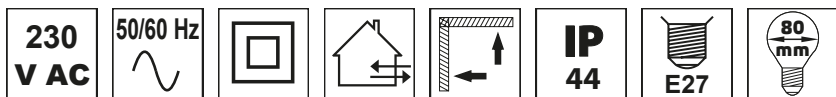

TRACON			L x W x H (mm)	Ei
TLH-08S	E27	max. 60 W	180 x 125 x 110	A++, A+, A, B, C, D, E

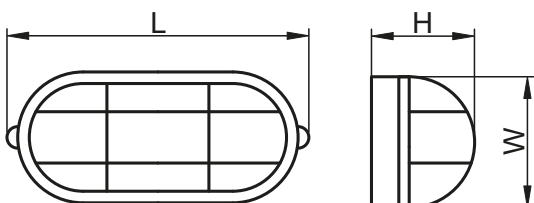
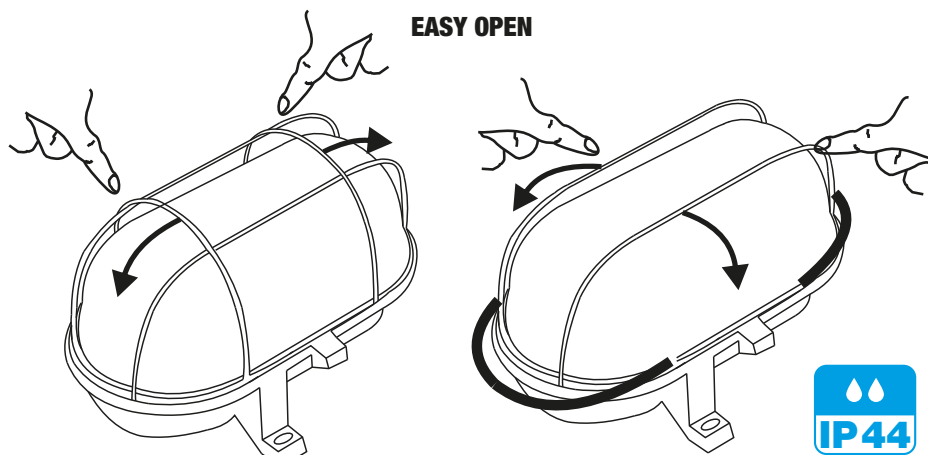

RELEVANT STANDARD
EN 60598



Védett, műanyag házas LED hajólámpa



TRACON				Tc [K]	L x W x H D x H (mm)	
LHIP08W	8 W	80 W	640 lm	4.000 K	180 x 155 x 85	A+
LHIPK8W	8 W	80 W	640 lm	4.000 K	155 x 85	A+



LHIP08W



LHIPK8W

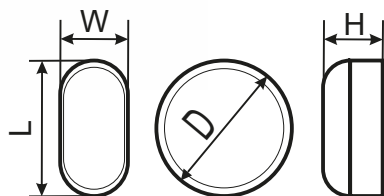

LED hajólámpa, műanyag házas



TRACON				Tc [K]	L x W x H D x H (mm)	
LHLM06NW	6 W	60 W	420 lm	4.000 K	165 x 116 x 70	A
LHLM012NW	12 W	100 W	840 lm	4.000 K	215 x 142 x 70	A
LHLMK6NW	6 W	60 W	420 lm	4.000 K	150 x 70	A
LHLMK12NW	12 W	100 W	840 lm	4.000 K	188 x 80	A
LHLMOS8NW	8 W	60 W	560 lm	4.000 K	168 x 100 x 58	A
LHLMOS15NW	15 W	100 W	1.050 lm	4.000 K	221 x 131 x 68	A
LHLMKS8NW	8 W	60 W	560 lm	4.000 K	140 x 58	A
LHLMKS15NW	15 W	100 W	1.050 lm	4.000 K	180 x 66	A



LHLMK..

LHLMO..

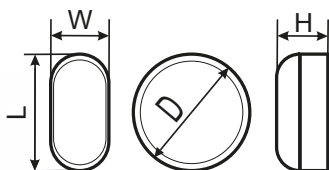

LHLMOS15NW



LHLMKS15NW



Védett LED ipari világítótest

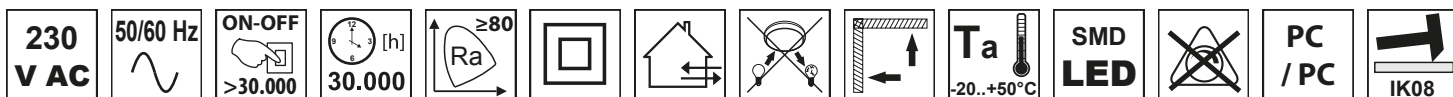

TRACON		LED		Tc [K]		L x W x H (mm)	
LVE0610W	10 W	18 W	900 lm	4.000 K	120°	715 x 53 x 35	A+
LVE0618W	18 W	2 x 18 W	1.600 lm	4.000 K	120°	715 x 53 x 35	A+
LVE1218W	18 W	36 W	1.600 lm	4.000 K	120°	1245 x 53 x 35	A+
LVE1236W	36 W	2 x 36 W	3.500 lm	4.000 K	120°	1245 x 53 x 35	A+
LVE1524W	24 W	58 W	2.160 lm	4.000 K	120°	1525 x 53 x 35	A+
LVE1545W	45 W	2 x 58 W	4.300 lm	4.000 K	120°	1525 x 53 x 35	A+

A termék nem sorolható!

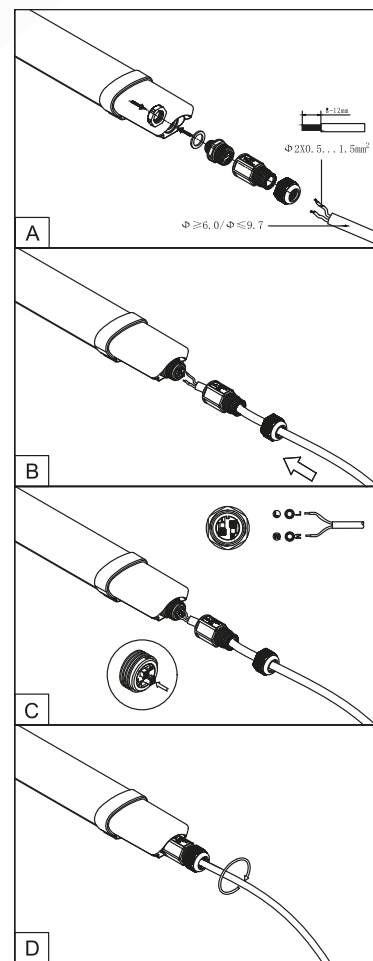
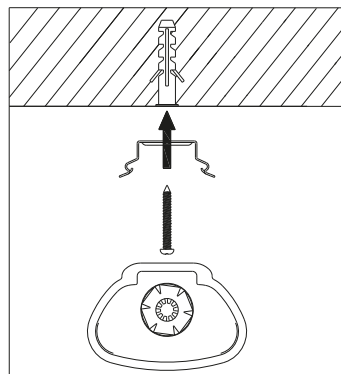
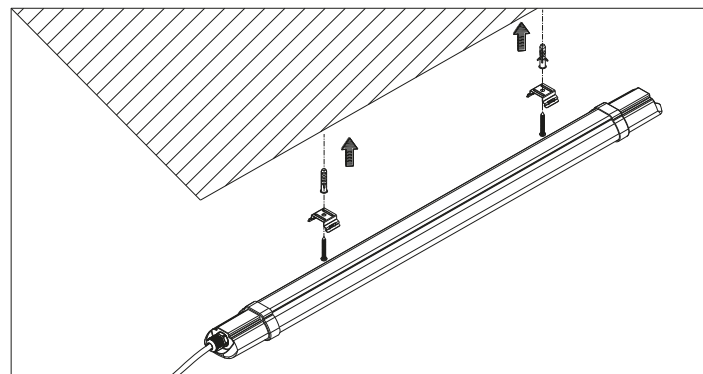

OLVASSA BE A KÓDOT!

- Nézze meg újdonságainkat
- Legyen naprakész

**Kínálatunk gyorsan és folyamatosan fejlődik!
Katalógusunk a 2021. áprilisi állapotot tükrözi.
Naprakész információért
látogasson el honlapunkra!**

Védett LED ipari világítótest



TRACON						L x W x H (mm)		
LV0612	12 W	18 W		66 x SMD3528	1.000 lm	590 x 86 x 66	-	A
LV0618	18 W	2 x 18 W		92 x SMD3528	1.500 lm	590 x 86 x 66	-	A
LV1224	24 W	36 W		132 x SMD3528	2.000 lm	1180 x 86 x 66	-	A
LV1236	36 W	2 x 36 W	BASIC	184 x SMD3528	3.000 lm	1180 x 86 x 66	-	A
LV1530	30 W	58 W		168 x SMD3528	2.500 lm	1480 x 86 x 72	-	A
LV1548	48 W	2 x 58 W		252 x SMD3528	4.000 lm	1480 x 86 x 72	-	A
LV1556	56 W	2 x 58 W		288 x SMD3528	4.500 lm	1480 x 86 x 72	-	A
LV1224E	24 W / 3 W	36 W		132 x SMD3528	2.000/280 lm	1180 x 86 x 66	1 h	A
LV1236E	36 W / 3 W	2 x 36 W		184 x SMD3528	3.000/280 lm	1180 x 86 x 66	1 h	A
LV1530E	30 W / 3 W	58 W		168 x SMD3528	2.500/280 lm	1480 x 86 x 72	1 h	A
LV1548E	48 W / 4 W	2 x 58 W		252 x SMD3528	4.000/350 lm	1480 x 86 x 72	1 h	A
LV1236M	36 W	2 x 36 W		184 x SMD3528	3.000 lm	1180 x 86 x 66	-	A
LV1548M	48 W	2 x 58 W		252 x SMD3528	4.000 lm	1480 x 86 x 72	-	A

A termék két oldali kábelbevezetéssel rendelkezik, így fűzve is szerelhető!

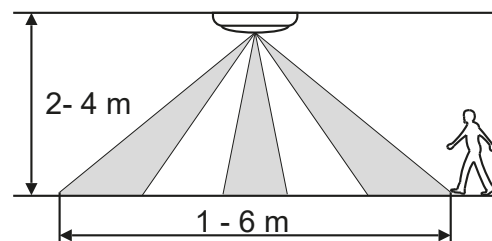
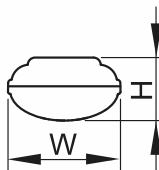
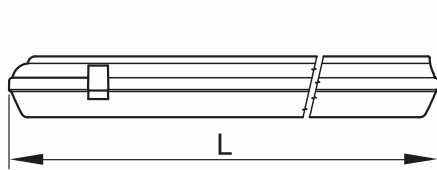

Védett LED ipari világítótest por és páramentes



TRACON					L x W x H (mm)		
LVH0609	9 W	18 W	BASIC	1.350 lm	600 x 77 x 66	-	A++
LVH0618	18 W	2 x 18 W		2.700 lm	600 x 77 x 66	-	A++
LVH1218	18 W	36 W		2.700 lm	1200 x 77 x 66	-	A++
LVH1236	36 W	2 x 36 W		5.400 lm	1200 x 77 x 66	-	A++
LVH1524	24 W	58 W		3.600 lm	1500 x 77 x 66	-	A++
LVH1548	48 W	2 x 58 W		7.200 lm	1500 x 77 x 66	-	A+
LVH1218E	18 W / 4 W	36 W		2.700 / 140 lm	1200 x 77 x 66	3 h	A++
LVH1236E	36 W / 4 W	2 x 36 W		5.400 / 140 lm	1200 x 77 x 66	3 h	A++
LVH1524E	24 W / 4 W	58 W		3.600 / 140 lm	1500 x 77 x 66	3 h	A++
LVH1548E	48 W / 4 W	2 x 58 W		7.200 / 140 lm	1500 x 77 x 66	3 h	A+
LVH1218M	18 W	36 W		2.700 lm	1200 x 77 x 66	-	A++
LVH1236M	36 W	2 x 36 W		5.400 lm	1200 x 77 x 66	-	A++
LVH1524M	24 W	58 W		3.600 lm	1500 x 77 x 66	-	A++
LVH1548M	48 W	2 x 58 W	7.200 lm	1500 x 77 x 66	-	A+	

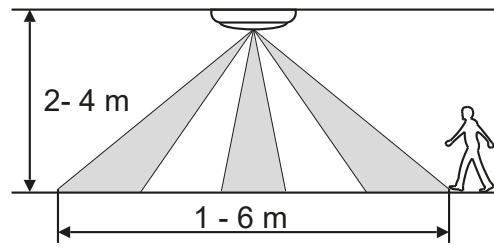
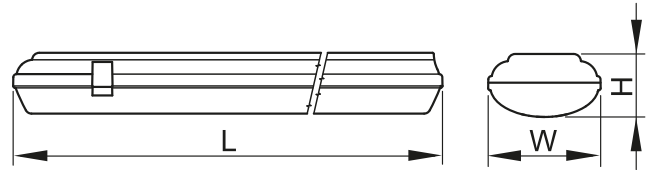

A fém klipszek tartozékok.

OLVASSA BE A KÓDOT!

- Nézze meg újdonságainkat
- Legyen naprakész

Kínálatunk gyorsan és folyamatosan fejlődik!
Katalógusunk a 2021. áprilisi állapotot tükrözi.
Naprakész információért látogasson el honlapunkra!

Védett lámpatest LED világító csövekhez

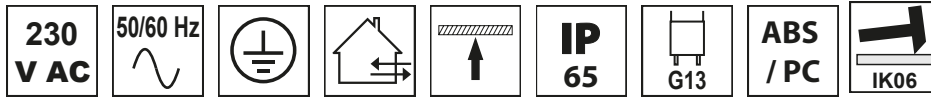

TRACON	LED			L x W x H (mm)	Ei
TLFVLED106	1 x 18 W	1 x 600 mm	x 6	655 x 72 x 86	A++, A+, A
TLFVLED112	1 x 36 W	1 x 1200 mm	x 10	1265 x 72 x 86	A++, A+, A
TLFVLED115	1 x 58 W	1 x 1500 mm	x 12	1565 x 72 x 86	A++, A+, A
TLFVLED206	2 x 18 W	2 x 600 mm	x 6	655 x 115 x 86	A++, A+, A
TLFVLED212	2 x 36 W	2 x 1200 mm	x 10	1265 x 130 x 92	A++, A+, A
TLFVLED215	2 x 58 W	2 x 1500 mm	x 12	1565 x 120 x 92	A++, A+, A

A lámpatestek egy oldalon táplált LED csövekhez (LT8G., LT8GH) vannak levezetékezve, a két oldalon táplált csövekhez a vezetékezés módosítása szükséges a használati útmutató alapján!

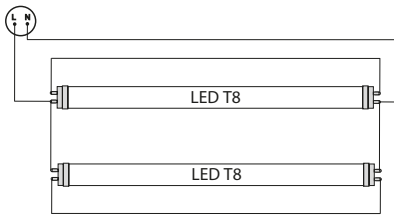

Inverteres vészvilágító kiegészítő egységek



TRACON	T5	T8	[h]	V	Ah
INV-1418	14 W	18 W	1,5 h	3,6 V	2.400 mAh
INV-2836	28 W	36 W	1,5 h	4,8 V	2.400 mAh
INV-3558	35 W	58 W	1,5 h	6 V	2.400 mAh
INV-DL-6	LED panelhez 6-18 W-ig		0,5 h	6 V	1.800 mAh
INV-DL-15	LED panelhez 18-50 W-ig, lásd E/41-42. oldal		0,5 h	19,2 V	1.500 mAh

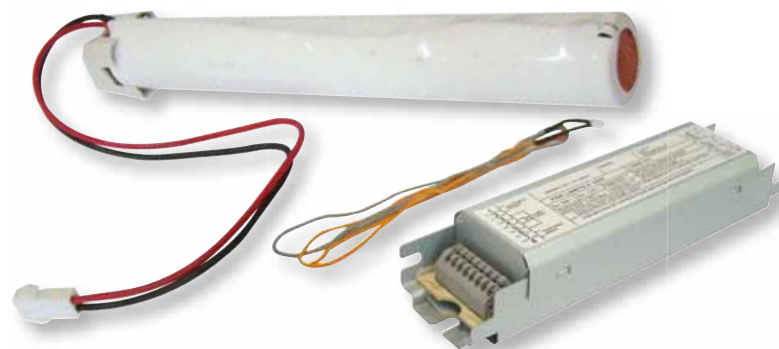

Az inverteres kiegészítő egységek beépítésével a lámpatestek alkalmassá tehetők arra, hogy a tápfeszültség megszűnése után a lámpatest vészvilágítóként funkcionáljon.



Az inverter biztosítja a fényforrás működését a tápfeszültség megléte esetén, a tápfeszültség megszűntekor pedig a fényforrás táplálását automatikusan átkapcsolja a benne található akkumulátorra.

Védett fénycsöves lámpatestek



TRACON			L x W x H (mm)	
TLFV-118E	1 x 18 W	6	655 x 72 x 86	A
TLFV-136E	1 x 36 W	10	1265 x 72 x 86	A
TLFV-158E	1 x 58 W	12	1565 x 72 x 86	A
TLFV-218E	2 x 18 W	6	655 x 115 x 86	A
TLFV-236E	2 x 36 W	10	1265 x 115 x 86	A
TLFV-258E	2 x 58 W	12	1565 x 115 x 86	A

TRACON			L x W x H (mm)	
TLFV-118M	1 x 18 W	6	655 x 89 x 92	A
TLFV-136M	1 x 36 W	10	1265 x 89 x 92	A
TLFV-158M	1 x 58 W	12	1565 x 89 x 92	A
TLFV-218M	2 x 18 W	6	655 x 130 x 92	A
TLFV-236M	2 x 36 W	10	1265 x 130 x 92	A
TLFV-258M	2 x 58 W	12	1565 x 130 x 92	A

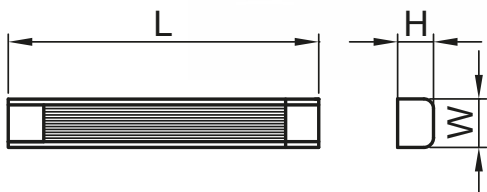

Elektronikus előtétek T8-as fénycsővel szerelt lámpatestekhez

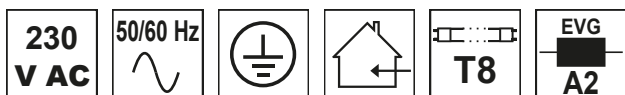

TRACON		L (mm)	W (mm)	H (mm)
TLFV-EE-118	1 x 18 W	275	28	27
TLFV-EE-136	1 x 36 W	275	28	27
TLFV-EE-158	1 x 58 W	320	32	28
TLFV-EE-218	2 x 18 W	275	28	27
TLFV-EE-236	2 x 36 W	320	32	28
TLFV-EE-258	2 x 58 W	320	32	28
TLFV-EE-418	4 x 18 W	332	33	28

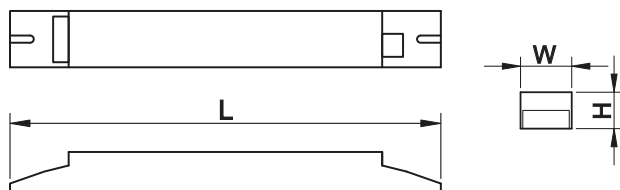

LED kijáratjelző világítótestek

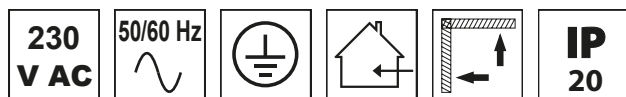

TRACON									L (mm)	W ₁ (mm)	W ₂ (mm)	H (mm)	
EXIT-01-J	4 W	3 h	240 lm	× 13	M	2.4 V	900 mAh	Ni-Cd	350	60	160	30	A
EXIT-02-J	3 W	3 h	180 lm	× 8	M	2.4 V	900 mAh	Ni-Cd	240	60	150	25	A
EXIT-03-J	6 W	3 h	360 lm	× 18	M	3.6 V	900 mAh	Ni-Cd	340	25	160	65	A

A folyamatos üzemű (M) lámpatestek rövid átkapcsolási idő után továbbra is működőképesek maradnak!

A matricakészlet tartozék!

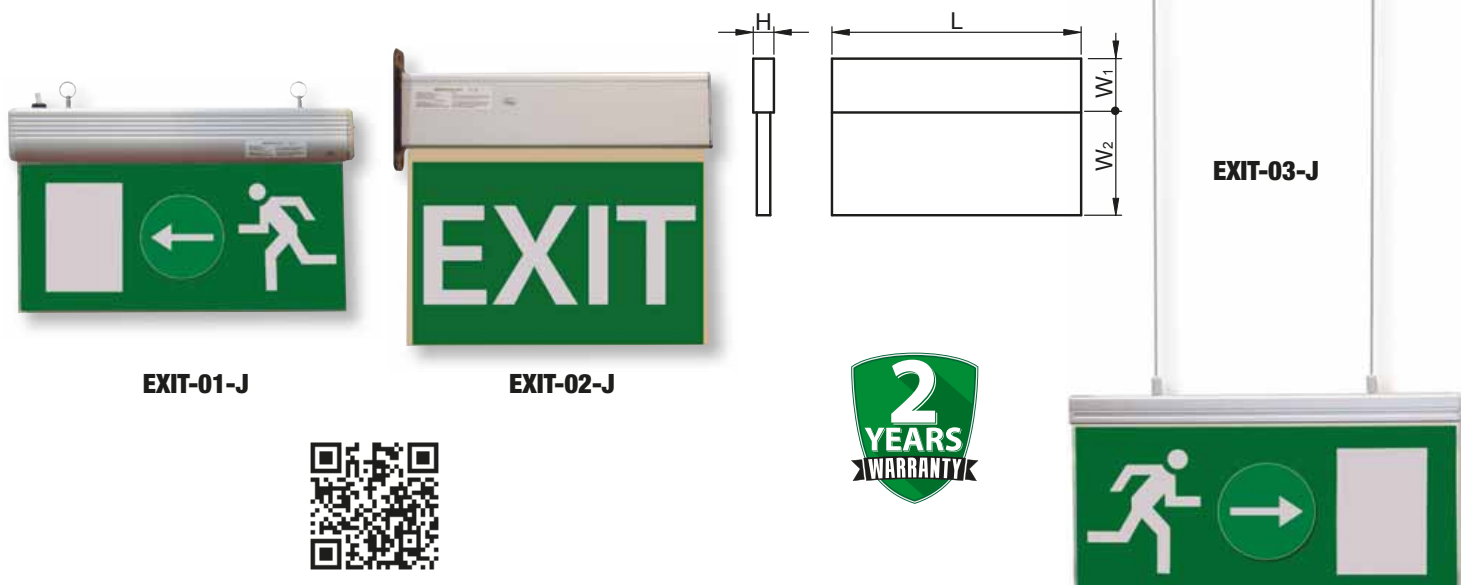

LED-es vészvilágító lámpatest, cserélhető lencsével

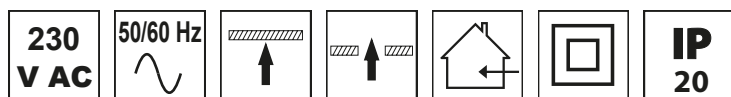

TRACON							D × H (mm)		
TLBVM3W	3 W	3 h	150 lm	4.8 V	900 mAh	Ni-Cd	134 × 45	NM	A



Vészvilágítók

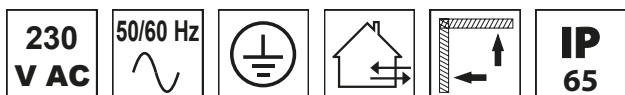

TRACON							L x W x H (mm)		
TLBV-18A	8 W	G5 (T5)	1 h	2.4 V	1.5 Ah	Ni-Cd	350 x 117 x 76	M	A
TLBV-18M	8 W	G5 (T5)	3 h	2.4 V	4.5 Ah	Ni-Cd	350 x 117 x 76	M	A
TLBV-18NM	8 W	G5 (T5)	3 h	2.4 V	4.5 Ah	Ni-Cd	350 x 117 x 76	NM	A
TLBVLED30NM	4 W	28 x LED	3 h	3.6 V	1,8 Ah	Ni-Cd	345 x 110 x 60	M/NM	A



A matricakészlet tartozék!

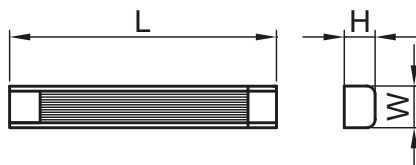

TLBV-18..

TLBVLED30NM

A vészvilágító lámpatestek biztosítják a normál villamos hálózat üzemzavara esetén a közlekedő utak megvilágítását.

A **folyamatos üzemű (M)** lámpatestek rövid átkapcsolási idő után továbbra is működőképesek maradnak, a **nem folyamatos üzemű (NM)** lámpatestek a külső villamos táplálás megszűnte után kapcsolnak be.

Az átkapcsolási/bekapcsolási idő kevesebb, mint 1 másodperc.

Kiegészítők



TLBV-18-KJ	Rápattintható kijáratjelző tábla TLBV-18.. világítótest mennyezetre való szereléséhez, "OLDAL" nyíl
TLBV-18-KL	Rápattintható kijáratjelző tábla TLBV-18.. világítótest mennyezetre való szereléséhez, "LE" nyíl
TLBVLED30NM-K	Süllyesztő keret TLBVLED30NM világítótesthez
TLBVLED30NM-KJ	Kijáratjelző tábla TLBVLED30NM világítótest mennyezetre való szereléséhez, állítható nyíl



TLBV-18-KJ



TLBVLED30NM-KJ

A matricakészlet tartozék!



TLBV-18-KL

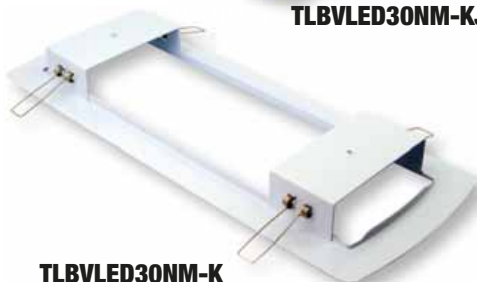

TLBVLED30NM-K

Védett LED bútorvilágítók, TLFLED széria



TRACON					L x W x H (mm)		
TLFLED20NW	20 W	28 W	1.440 lm	4.000 K	900 x 53 x 65	-	A
TLFLEDS8NW	8 W	10 W	650 lm	4.000 K	492 x 59 x 66	✓	A
TLFLEDS15NW	15 W	21 W	1.080 lm	4.000 K	682 x 59 x 66	✓	A



LED bútorvilágítók, TLLED széria

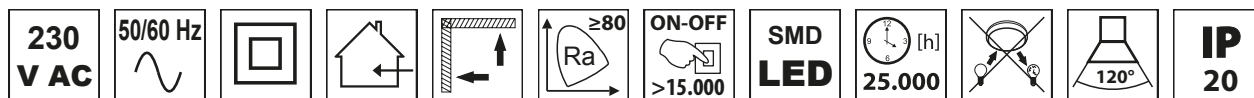

TRACON						L x W x H (mm)	
TLLED10W	✓	10 W	18 W	700 lm	4.500 K	605 x 30 x 43	A+
TLLED20W	✓	20 W	30 W	1.400 lm	4.500 K	1225 x 30 x 43	A+
TLLED24W	✓	24 W	36 W	2.000 lm	4.500 K	1525 x 30 x 43	A+
TLLEDB10W	-	10 W	18 W	700 lm	4.500 K	605 x 30 x 43	A+
TLLEDB20W	-	20 W	30 W	1.400 lm	4.500 K	1225 x 30 x 43	A+
TLLEDB24W	-	24 W	36 W	2.000 lm	4.500 K	1525 x 30 x 43	A+

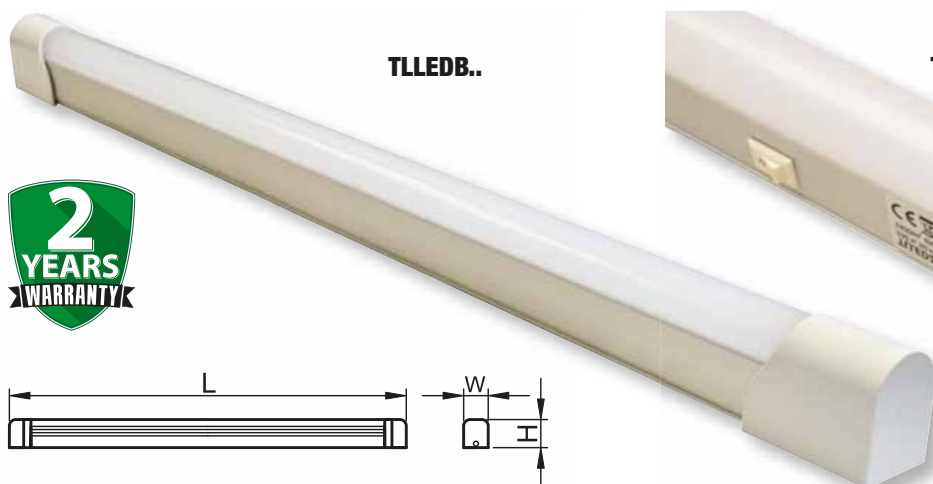

LED bútorvilágítók, műanyag házas

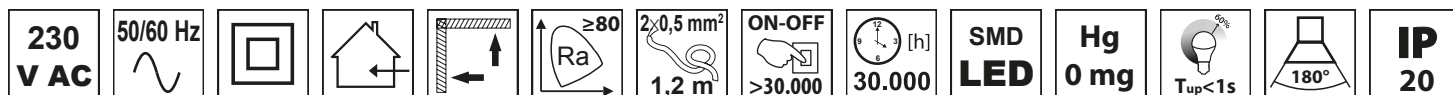

TRACON					L x W x H (mm)	x SMD2835	
	5 W	7 W	400 lm	T _c [K]			A
LBV5WW	5 W	7 W	400 lm	3.000 K	300 × 22 × 35	26	A
LBV5NW	5 W	7 W	400 lm	4.500 K	300 × 22 × 35	26	A
LBV10WW	10 W	14 W	800 lm	3.000 K	600 × 22 × 35	52	A
LBV10NW	10 W	14 W	800 lm	4.500 K	600 × 22 × 35	52	A
LBV15WW	15 W	21 W	1.200 lm	3.000 K	900 × 22 × 35	76	A
LBV15NW	15 W	21 W	1.200 lm	4.500 K	900 × 22 × 35	76	A
LBV20WW	20 W	28 W	1.600 lm	3.000 K	1200 × 22 × 35	100	A
LBV20NW	20 W	28 W	1.600 lm	4.500 K	1200 × 22 × 35	100	A

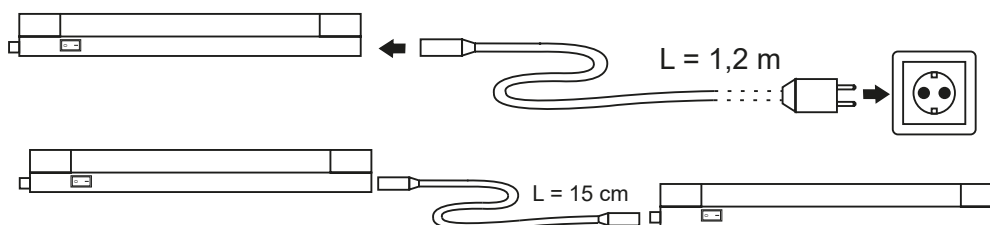
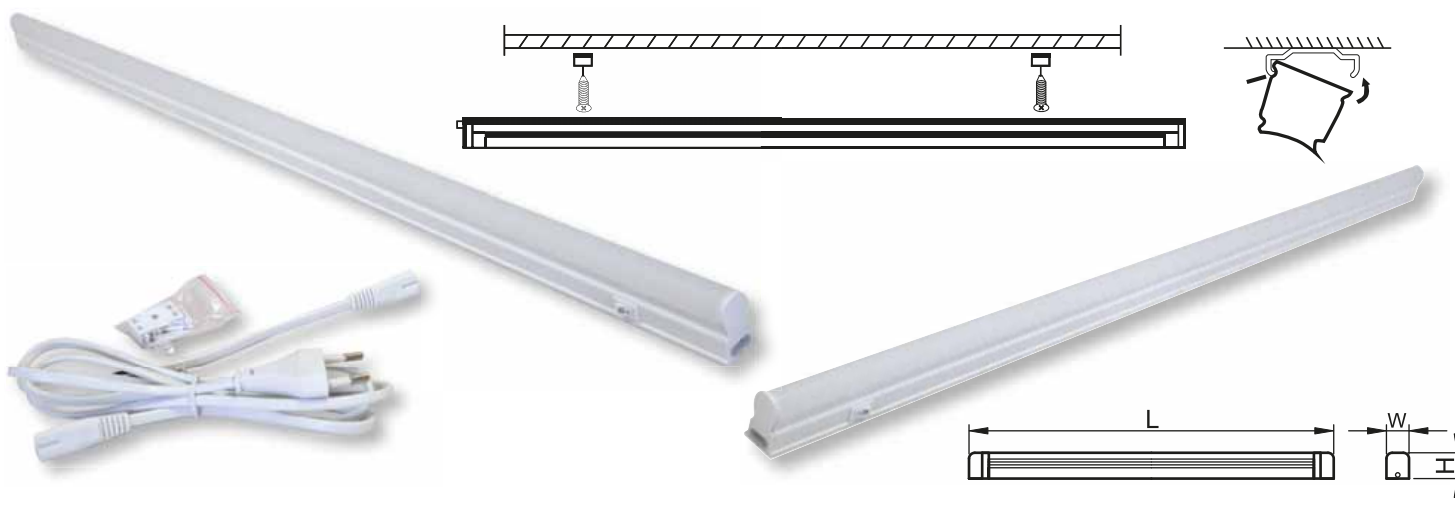

Σ max. 2300 W !

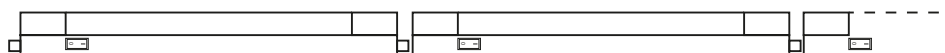

LED tükörvilágító lámpa

230 V AC 50/60 Hz 25.000 [h] ON-OFF >15.000 SMD LED Ra ≥80 120° IP 44

TRACON				Tc [K]	L x W x H (mm)	
BL0408NW	8 W	10 W	500 lm	4.000 K	400 x 121 x 42	A
BL0612NW	12 W	18 W	860 lm	4.000 K	600 x 121 x 42	A
BL0915NW	15 W	21 W	1.080 lm	4.000 K	780 x 121 x 42	A

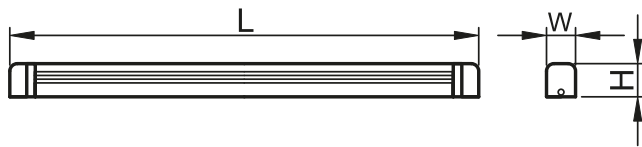

TGE ELOSZTÓSZEKRÉNYEK

TRACON ELECTRIC®



H/14

Nyitott lámpatest T8 LED világító csövekhez

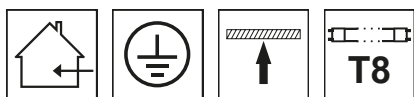

TRACON	LED		L x W x H (mm)	Ei
ELV109	1 x 9 W	600 mm	610 x 34 x 44,5	A, A+, A++
ELV209	2 x 9 W	600 mm	617 x 72 x 51	A, A+, A++
ELV118	1 x 18 W	1.200 mm	1220 x 34 x 44,5	A, A+, A++
ELV218	2 x 18 W	1.200 mm	1227 x 72 x 51	A, A+, A++

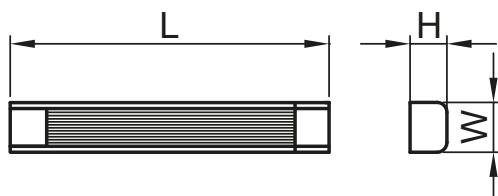

A lámpatestek egyoldali táplálású LED világító csövekhez (LT8G..., LT8GH) vannak levezetékezve!

Normál szerelőlámpák



TRACON			W	Ei
STL-02	-	8 W	A	
STL-03	E27	60 W	A++, A+, A,	
STL-04	E27	60 W	B, C, D, E	



STL-02
szerelőlámpa







STL-03
szerelőlámpa
fém védőkerettel





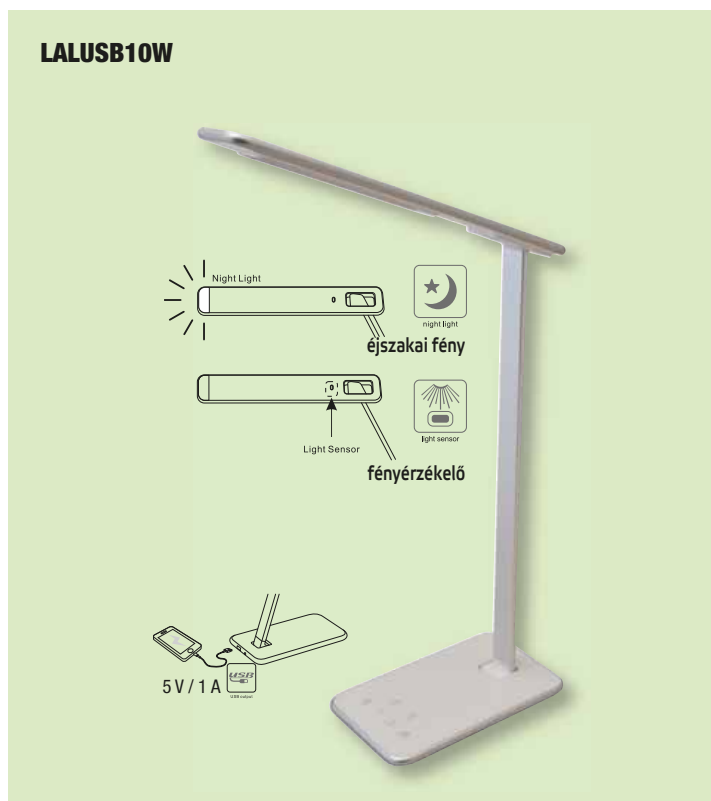

STL-04
szerelőlámpa
műanyag védőkerettel

LED asztali világítótestek

TRACON			Tc [K] 	
LAL4W	4 W	280 lm	2.700-6.000 K	20-40-60-80-100 %
LALD4W	4 W	280 lm	2.700-6.000 K	20-40-60-80-100 %
LALD4WB	4 W	280 lm	2.700-4.500-6.000 K	20-40-60-80-100 %
LALB4W	4 W	280 lm	2.700-6.000 K	20-40-60-80-100 %
LALUSB10W	10 W	700 lm	2.700-6.000 K	20-40-60-80-100 %



LED asztali világítótestek

TRACON				
LALBFLEX6W	6 W	700 lm	4.000 K+RGB	30-60-100 %
LALG3W	3 W	200 lm	4.000 K+RGB	30-60-100 %
LALUSBM10W	10 W	700 lm	2.700-6.000 K	20-40-60-80-100 %
LALSLIM4W	4 W	330 lm	4.000 K	20-40-60-80-100 %
LALCM8W	8 W	150 lm	6.000 K	20-40-60-80-100 %



LED asztali világítótestek

LED süllyesztett lépcsővilágítók, LVS széria



TRACON				Tc [K]	L x W x H (mm)	Ei
LVS01	1,5 W	100 lm		3.500 K	110 x 44 x 45	A
LVS02	1,5 W	100 lm		3.500 K	110 x 44 x 45	A

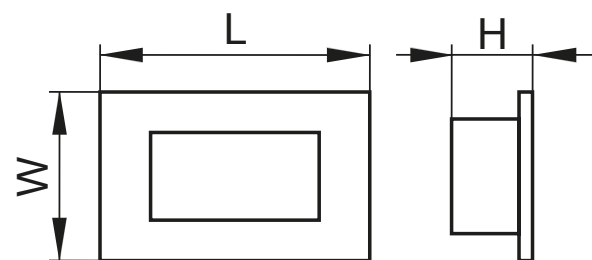

RELEVANT STANDARD
EN 60598

LED földbe süllyeszthető világítótestek



TRACON			Tc [K]	D x L (mm)	Ei
LGL3W	3 W	210 lm	4.500 K	100 x 100	A
LGL7W	7 W	490 lm	4.500 K	160 x 110	A
LGL12W	12 W	840 lm	4.500 K	210 x 115	A
LGL18W	18 W	1.260 lm	4.500 K	260 x 125	A

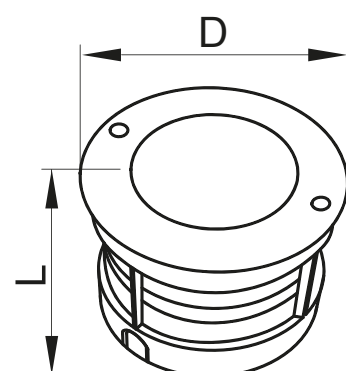

Kültéri LED fali világítótestek, GARC széria

100-240 V AC	50/60 Hz	[h] 30.000	ON-OFF >30.000	Ta -20..+50°C				SMD LED	≥ 70		IP 54
------------------------	----------	---------------	--------------------------	-------------------------	--	--	--	----------------	-----------	--	--------------

TRACON			[lm]	Tc [K]	[°]	L x W x H (mm)	
GARCA6W	6 W	45 W	360 lm	4.000 K	30°	157 x 106 x 130	A
GARCB12W	12 W	75 W	680 lm	4.000 K	30°	238 x 106 x 130	A



GARCA6W



GARCA12W

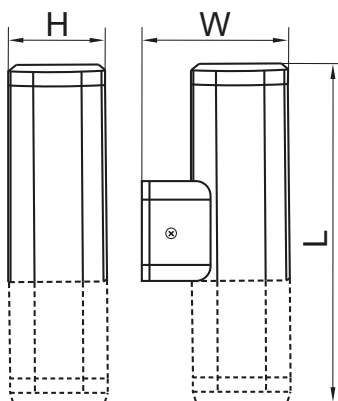

Kültéri LED fali világítótestek, GLOO széria

230 V AC	50/60 Hz	≥ 80	SMD LED	[h] 50.000	ON-OFF >30.000		Ta -20..+50°C	[m] 1	IP 65	
--------------------	----------	-----------	----------------	---------------	--------------------------	--	-------------------------	----------	--------------	--

TRACON			[lm]	Tc [K]	[°]	L x W x H (mm)	
GLOO8NW	8 W	60 W	650 lm	4.000 K	120°	140 x 170 x 59	A+

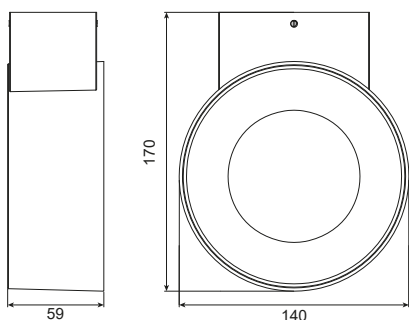

Kültéri LED világítótestek



TRACON				Tc [K]	L x W x H (mm)	
GARD8W	8 W	60 W	550 lm	3.000 K	230 x 156 x 260	A+
GARU8W	8 W	60 W	550 lm	3.000 K	230 x 156 x 265	A+
GARUM8W *	8 W	60 W	550 lm	3.000 K	230 x 156 x 290	A+
GARP8W	8 W	60 W	550 lm	3.000 K	178 x 156 x 334	A+
GARST8W	8 W	60 W	550 lm	3.000 K	178 x 156 x 1000	A+

* mozgásérzékelős kivitel



GARD8W

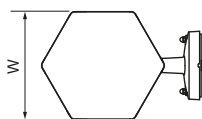
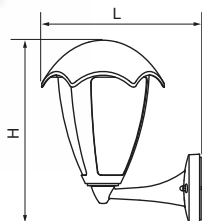

GARU8W

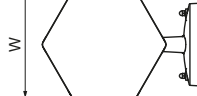
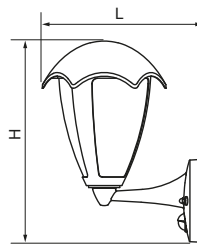

GARST8W

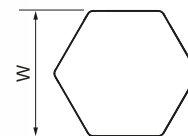
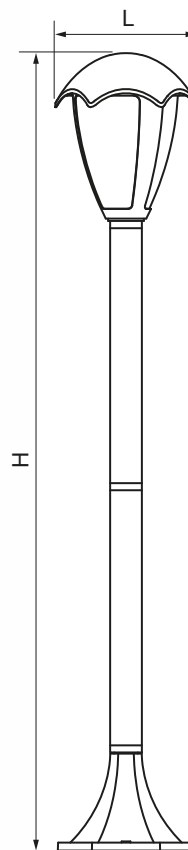

GARUM8W

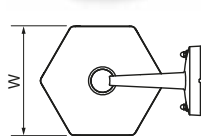
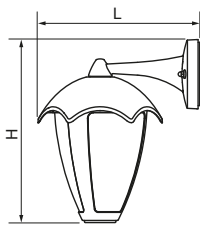

GARP8W

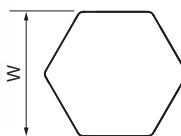
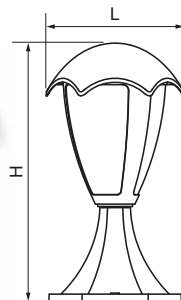

OLVASSA BE A KÓDOT!

- Nézze meg újdonságainkat
- Legyen naprakész

**Kínálatunk gyorsan és folyamatosan fejlődik!
Katalógusunk a 2021. áprilisi állapotot tükrözi.**

**Naprakész információért
látogasson el honlapunkra!**

Kültéri LED lámpatestek E27 foglalattal

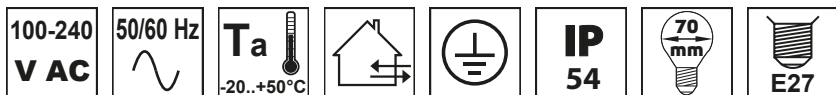

TRACON			L x W x H (mm)	Ei
GARUE27	E27	max 60 W	140 x 156 x 315	A++,A+,A,B,C,D,E
GARDE27	E27	max 60 W	140 x 156 x 315	A++,A+,A,B,C,D,E
GARHE27	E27	max 60 W	140 x 156 x 890	A++,A+,A,B,C,D,E
GARUME27 *	E27	max 60 W	140 x 156 x 365	A++,A+,A,B,C,D,E
GARPE27	E27	max 60 W	170 x 156 x 365	A++,A+,A,B,C,D,E
GARSTE27	E27	max 60 W	170 x 156 x 1000	A++,A+,A,B,C,D,E
GARTRIE27	3 x E27	3 x max 60 W	475 x 550 x 2080	A++,A+,A,B,C,D,E

* mozgásérzékelős kivitel



Alkonykapcsolók

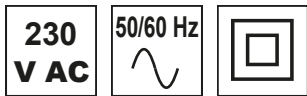

TRACON	I_n	lux	ON - t _{off}	IP..	L x W x H (mm)
ALK-OUT	10 A	5-50 lux	-	IP 44	∅ 82 x 108
ALK-BOX	16 A	2-100 lux	-	IP 20	90 x 35 x 66
ALK-IN	5 A	2-100 lux	1-8 h, OFF	IP 44	109 x 70 x 40
ALK-472	1 A (100 W)	5-15 lux	1-12 h, OFF	IP 20	∅ 52 x 89
ALK110	-	50-800 lux, 1-10 VDC	-	IP 20	∅ 21 x 64

Névleges kapcsolható teljesítmény

TRACON	ALK-OUT	ALK-BOX	ALK-IN	ALK-472
	300 W	500 W	900 W	100 W
HALOGEN	200 W	300 W	500 W	100 W
CFL	100 W	120 W	200 W	50 W
LED	100 W	120 W	200 W	50 W

Minden alkonykapcsoló jellegzetessége, hogy az első feszültségre való kapcsolás után egy be- és kikapcsolásból álló öntesztet végeznek. A normál, üzemszerű működés az önteszt után 15 s – 1 min időkésleltetés után indul.

Az ALK110 érzékelő egy 1-10 V-os vezérlőjellel alkalmas az ilyen bemenettel rendelkező lámpatestek külső megvilágítás szerinti vezérlésére. Az érzékelő külső tápellátást nem igényel.



ALK-BOX



ALK-IN



ALK-OUT



ALK-472



ALK110



EDSS ELOSZTÓDOBOZOK



TRACON
ELECTRIC®

H/4

PRS.. Jelenlét-érzékelő

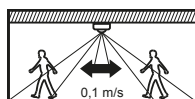
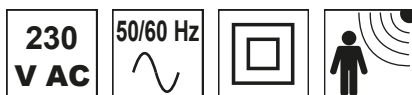

TRACON	(°)	lux	clock icon	IP..	L x W x H D x H (mm)
PRS46B	360°	3-2.000 lux	10 s...30 min.	IP 20	102 x 102 x 58
PRS47	360°	3-2.000 lux	10 s...30 min.	IP 44	111,5 x 65,2

Névleges kapcsolható teljesítmény

TRACON	PRS46B	PRS47
	1.200 W	2.000 W
HALOGEN	1.000 W	2.000 W
CFL	300 W	1.000 W
LED	300 W	1.000 W
h_t	2,2 - 6 m	2,2 - 6 m
L_s	< 20 m	< 20 m

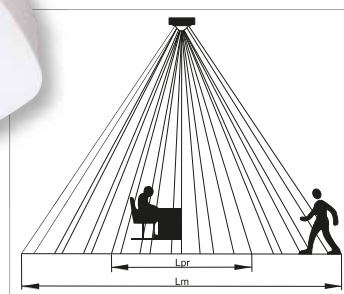

PRS47



A test legkisebb mozdulatait is érzékeli. Ezért olyan helyiségekben, ahol az emberek hosszabb ideig statikusan tartózkodnak (WC, iroda) jól alkalmazhatók a világítás vezérlésére.

Speciális mozgásérzékelők

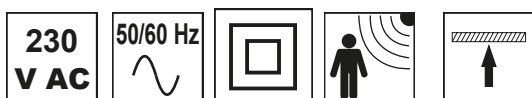

TRACON	(°)	L x W x H (mm)	Light bulb icon / LED
TMBK122	120°	78 x 36 x 21	500 W / 200 W
TMBB123	120°	78 x 36 x 21	500 W / 200 W
TMBC125	120°	90 x 40 x 17	500 W / 200 W

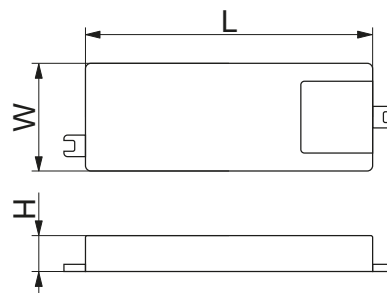

* Névleges kapcsolható teljesítmény

Rövid hatótávú
mozgásérzékelő,
működtetés kézzel



Rövid hatótávú
mozgásérzékelő,
működtetés ajtóval



Kapacitív
érintőkapcsoló



Radaros (mikrohullámú) mozgásérzékelők

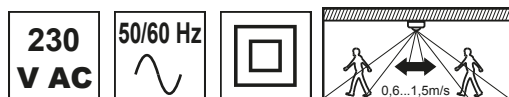

TRACON	(°)	lux	🕒	L x W x H D x H (mm)	IP..
TMB-L01G	360°	3-2.000 lux	10 s ... 12 min.	81 x 42 x 44	IP 20
TMB-L01D	360°	3-2.000 lux	10 s ... 12 min.	58 x 41 x 26	IP 20
TMB-L01M	360°	3-2.000 lux	10 s ... 12 min.	56 x 40 x 23	IP 20
TMB-L01DIMM	360°	3-2.000 lux	5 s ... 30 min.	78 x 45 x 26	IP 20
TMB-152R	180°	3-2.000 lux	10 s ... 12 min.	86 x 60 x 79	IP 44
TMB-054R	180°	3-2.000 lux	10 s ... 12 min.	80 x 80 x 32	IP 20
TMB-061R	360°	3-2.000 lux	10 s ... 12 min.	∅ 76 x 76	IP 20
TMB-ME51	360°	3-2.000 lux	10 s ... 12 min.	71 x 50 x 82	IP 20

Névleges kapcsolható teljesítmény

TRACON	💡	HALOGEN	CFL	LED	h _t	L _s
TMB-L01G	1.200 W	1.000 W	300 W	300 W	1,5 - 8 m	1 - 8 m
TMB-L01D	500 W	400 W	200 W	200 W	1,5 - 8 m	1 - 8 m
TMB-L01M	1.200 W	800 W	300 W	300 W	1,5 - 8 m	1 - 8 m
TMB-L01DIMM	600 W	300 W	200 W	200 W	1,5 - 8 m	1 - 8 m
TMB-152R	1.200 W	800 W	300 W	300 W	1,5 - 3,5 m	5 - 15 m
TMB-054R	1.200 W	800 W	300 W	300 W	1,5 - 1,8 m	1 - 15 m
TMB-061R	1.200 W	800 W	300 W	300 W	1,5 - 3,5 m	1 - 8 m
TMB-ME51	60 W	60 W	30 W	30 W	2 - 4 m	1 - 5 m

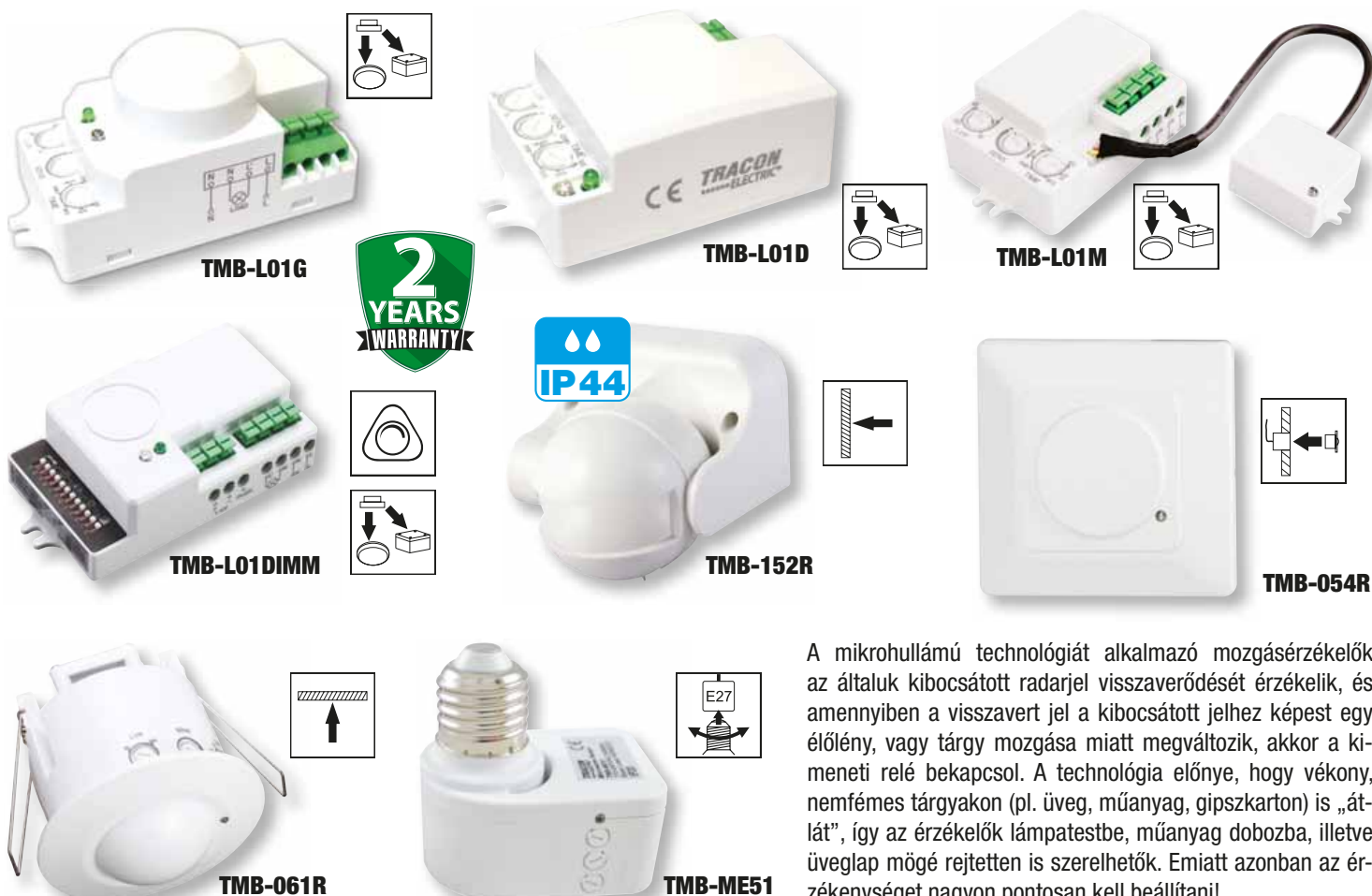

A mikrohullámú technológiát alkalmazó mozgásérzékelők az általuk kibocsátott radarjel visszaverődését érzékelik, és amennyiben a visszavert jel a kibocsátott jelhez képest egy élőlény, vagy tárgy mozgása miatt megváltozik, akkor a kimeneti relé bekapcsol. A technológia előnye, hogy vékony, nemfémes tárgyakon (pl. üveg, műanyag, gipszkarton) is „átlát”, így az érzékelők lámpatestbe, műanyag dobozba, illetve üveglap mögé rejtetten is szerelhetők. Emiatt azonban az érzékenységet nagyon pontosan kell beállítani!

Beltéri infravörös mozgásérzékelők

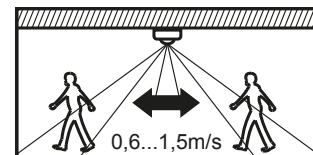
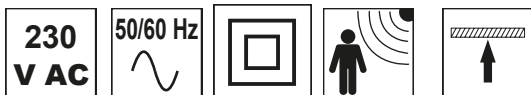

TRACON	(°)	lux	clock icon	L x W x H D x H (mm)	IP..
TMB-060	160°	3-2.000 lux	10 s ... 7 min.	80 x 80 x 34	IP 20
TMB-061	360°	3-2.000 lux	10 s ... 15 min.	∅ 76 x 76	IP 20
TMB-061M	360°	3-2.000 lux	10 s ... 15 min.	∅ 50 x 67	IP 20
TMB-062	190°	3-2.000 lux	10 s ... 7 min.	80 x 80 x 48	IP 20
TMB-E50	360°	3-2.000 lux	10 s ... 5 min.	∅ 64,5 x 127	IP 20
TMB-DA	120°	3-2.000 lux	10 s ... 15 min.	98 x 81 x 45	IP 20
TMB-011	360°	3-2.000 lux	10 s ... 15 min.	∅ 88 x 42	IP 20
TMB-011L	360°	3-2.000 lux	10 s ... 15 min.	∅ 115 x 24	IP 20

Névleges kapcsolható teljesítmény

TRACON	incandescent icon	HALOGEN	CFL	LED	h _t	L _s
TMB-060	1.000 W	800 W	300 W	300 W	1 - 1,8 m	<9 m
TMB-061	1.000 W	900 W	300 W	300 W	2,2 - 4 m	<6 m
TMB-061M	800 W	600 W	400 W	400 W	2,2 - 4 m	<6 m
TMB-062	500 W	300 W	200 W	200 W	1 - 1,8 m	<9 m
TMB-E50	60 W	60 W	30 W	30 W	2 - 3,5 m	<6 m
TMB-DA	1.200 W	800 W	300 W	300 W	1 - 1,8 m	<2 - 9 m
TMB-011	1.200 W	800 W	300 W	300 W	2,2 - 4 m	<6 m
TMB-011L	2.000 W	1.500 W	1.000 W	1.000 W	2,2 - 4 m	<6 m



TMB-060



TMB-061



TMB-061M



TMB-062



TMB-E50



TMB-DA



TMB-011



TMB-011L

Védett infravörös mozgásérzékelők

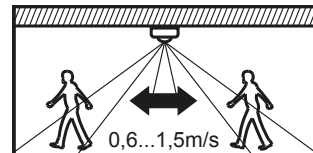

TRACON	(°)	lux	clock icon	L x W x H D x H (mm)	IP..
TMB-108	180°	3-2.000 lux	10 s ... 7 min.	82 x 104 x 72	IP 44
TMB-112	180°	3-2.000 lux	10 s ... 15 min.	91 x 84 x 63	IP 44
TMB-112F	180°	3-2.000 lux	10 s ... 15 min.	91 x 84 x 63	IP 44
TMB-118	360°	3-2.000 lux	10 s ... 15 min.	119 x 60 x 79	IP 44
TMB-016	180°	3-2.000 lux	10 s ... 15 min.	120 x 78 x 28	IP 44
TMB-011IP	360°	3-2.000 lux	10 s ... 15 min.	80 x 41	IP 44
TMB-311IP *	360°	3-2.000 lux	10 s ... 15 min.	88 x 55	IP 44
TMB-115	180°	3-2.000 lux	10 s ... 15 min.	80 x 117 x 51	IP 65
TMB-011LIP	360°	3-2.000 lux	10 s ... 15 min.	110 x 27	IP 65
TMBT29	360°	3-2.000 lux	10 s ... 30 min.	136 x 33 x 28	IP 65

* 3 érzékelős kivitel

Névleges kapcsolható teljesítmény

TRACON	incandescent icon	HALOGEN	CFL	LED	ht	Ls
TMB-108	1.000 W	800 W	300 W	300 W	1,8 - 2,5 m	<12 m
TMB-112	1.000 W	800 W	300 W	300 W	1,8 - 2,5 m	<12 m
TMB-112F	1.000 W	800 W	300 W	300 W	1,8 - 2,5 m	<12 m
TMB-118	1.200 W	800 W	300 W	300 W	1,8 - 2,5 m	<12 m
TMB-016	1.200 W	800 W	300 W	300 W	1,8 - 2,5 m	<12 m
TMB-011IP	1.200 W	800 W	600 W	600 W	2,2 - 4 m	<6 m
TMB-311IP	1.200 W	500 W	300 W	300 W	2,2 - 4 m	<12 m
TMB-115	1.000 W	800 W	300 W	300 W	1,8 - 2,5 m	<12 m
TMB-011LIP	2.000 W	1.500 W	1.000 W	1.000 W	2,2 - 4 m	<8 m
TMBT29	1.200 W	800 W	500 W	500 W	2 - 6 m	<10 m

A passzív infravörös mozgásérzékelők (PIR) a tárgyak által kibocsátott hő elmozdulását érzékelik, és megfelelő nagyságú elmozdulás esetén az érzékelőbe épített relé bekapcsol.

Emiatt az érzékelőnek rá kell „látania” a mozgó tárgyra, enélkül érzékelés és kapcsolás nem történik. Az érzékenység keresztirányú mozgásra mindig nagyobb, közeledő mozgásra kisebb, ezért az egy szenzorral szerelt érzékelőket a várható mozgási iránnyal párhuzamosan ajánljuk elhelyezni. **Az infravörös mozgásérzékelők érzékenysége nem állítható!**



KÁBELDOBOS HOSSZABBÍTÓK

G/7

Védett infravörös mozgásérzékelők



TMB-108



TMB-112



TMB-112F



TMB-118



TMB-016



TMB-011IP



TMB-311IP



TMB-115



TMB-011LIP



TMBT29



OLVASSA BE A KÓDOT!

- Nézze meg újdonságainkat
- Legyen naprakész

Kínálatunk gyorsan és folyamatosan fejlődik!
Katalógusunk a 2021. áprilisi állapotot tükrözi.

Naprakész információért
látogasson el honlapunkra!

Fém házas, védett ELG LED meghajtók



100-305 V AC 50/60 Hz PFC IP 65

TRACON					$\eta\%$	L x W x H (mm)
ELG-150-12APL	150 W	12 VDC	0,9 A	10 A	88 %	219 x 63 x 35,5
ELG-150-24A-3Y	150 W	24 VDC	0,9 A	6,25 A	89 %	219 x 63 x 35,5
ELG-200-12A-3Y	200 W	12 VDC	1,2 A	16 A	90 %	244 x 71 x 37,5
ELG-200-24A-3Y	200 W	24 VDC	1,2 A	8,4 A	92 %	244 x 71 x 37,5

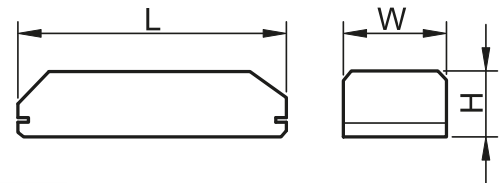

Fém házas, védett HLG LED meghajtók



100-305 V AC 50/60 Hz PFC IP 65

TRACON					$\eta\%$	L x W x H (mm)
HLG-150H-12A	150 W	10,8-13,5 VDC	0,75 A	7,5-12,5 A	91,5 %	228 x 68 x 38,8
HLG-240H-12A	240 W	11,2-12,8 VDC	2 A	8-16 A	90 %	251 x 68 x 38,8
HLG-240H-24A	240 W	22,4-25,6 VDC	2 A	5-10 A	92,5 %	251 x 68 x 38,8
HLG-320H-12A	320 W	10,8-13,5 VDC	1,65 A	11-22 A	91 %	252 x 90 x 43,8
HLG-320H-24A	320 W	21-26 VDC	1,65 A	6,7-13,3 A	94,5 %	252 x 90 x 43,8

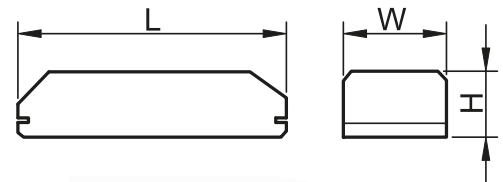

Dugaszolható tápegységek

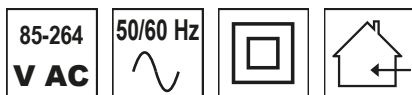

TRACON					$\eta\%$	L x W x H (mm)
GST25E12-P1J	25 W	12 VDC	0,35 A	2,08 A	86,5 %	79 x 54 x 33
GST36E12-P1J	36 W	12 VDC	0,45 A	3 A	87,5 %	79 x 54 x 33
SGA60E12-P1J	60 W	12 VDC	0,75 A	5 A	88 %	93,5 x 35 x 51,5

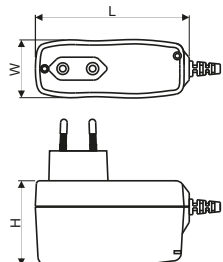

Sínre pattintható tápegységek

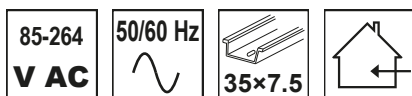

TRACON					$\eta\%$	L x W x H (mm)
HDR-15-12	15 W	10,8-13,8 VDC	0,25 A	1,25 A	85 %	17,5 x 90 x 54,5
HDR-15-24	15 W	21,6-29 VDC	0,25 A	0,63 A	86 %	17,5 x 90 x 54,5
HDR-30-12	30 W	10,8-13,8 VDC	0,48 A	2 A	88 %	35 x 90 x 54,5
HDR-30-24	30 W	21,6-29 VDC	0,48 A	1,5 A	89 %	35 x 90 x 54,5
HDR-60-12	60 W	10,8-13,8 VDC	0,8 A	4,5 A	88 %	52,5 x 90 x 54,5
HDR-60-24	60 W	21,6-29 VDC	0,8 A	2,5 A	90 %	52,5 x 90 x 54,5
HDR-100-12N	100 W	12-13,8 VDC	1,6 A	7,5 A	88 %	70 x 90 x 54,5
HDR-100-24N	100 W	21,6-29 VDC	1,6 A	4,2 A	90 %	70 x 90 x 54,5
NDR-120-12	120 W	12-14 VDC	1,3 A	10 A	85,5 %	40 x 125 x 113
NDR-120-24	120 W	24-28 VDC	1,3 A	5 A	88 %	40 x 125 x 113
NDR-240-24	240 W	24-28 VDC	1,3 A	10 A	88,5 %	63 x 125 x 113



HDR-15..



HDR-30..



HDR-60..



HDR-100..

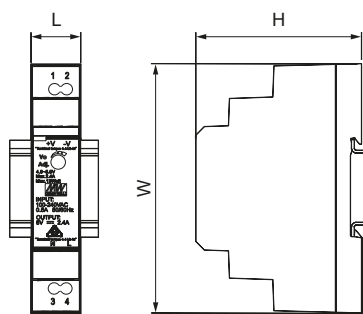

NDR-120..



NDR-240-24

Fém házas LED meghajtók

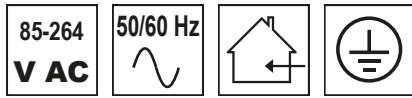

TRACON					$\eta\%$	PFC	L x W x H (mm)
RS-15-12	15 W	10,8-13,2 VDC	0,25 A	1,3 A	81 %	–	62,5 x 51 x 28
RS-15-24	15 W	22-27,6 VDC	0,25 A	0,625 A	82 %	–	62,5 x 51 x 28
RS-25-12	25 W	10,8-13,2 VDC	0,4 A	2,1 A	81 %	–	78 x 51 x 28
RS-25-24	25 W	22-27,6 VDC	0,4 A	1,1 A	86 %	–	78 x 51 x 28
LRS-35-12	35 W	10,2-13,8 VDC	0,42 A	3 A	86 %	–	92 x 88 x 30
LRS-35-24	35 W	21,6-28,8 VDC	0,42 A	1,5 A	88 %	–	92 x 88 x 30
LRS-50-12	50 W	10,2-13,8 VDC	0,56 A	4,2 A	86 %	–	99 x 82 x 30
LRS-50-24	50 W	21,6-28,8 VDC	0,56 A	2,2 A	88 %	–	99 x 82 x 30
LRS-75-12	75 W	10,2-13,8 VDC	0,85 A	6 A	89 %	–	99 x 97 x 30
LRS-75-24	75 W	21,6-28,8 VDC	0,85 A	3,2 A	90 %	–	99 x 97 x 30
LRS-100-12	100 W	10,2-13,8 VDC	1,2 A	8,5 A	88 %	–	127 x 97 x 30
LRS-100-24	100 W	21,6-28,8 VDC	1,2 A	4,5 A	90 %	–	127 x 97 x 30
LRS-150-12	150 W	10,2-13,8 VDC	1,7 A	12,5 A	87 %	–	159 x 97 x 30
LRS-150-24	150 W	21,6-28,8 VDC	1,7 A	6,5 A	89 %	–	159 x 97 x 30
RSP-200-12	200 W	10-13,2 VDC	1,1 A	16,7 A	85 %	✓	215 x 115 x 30
RSP-200-24	200 W	20-26,4 VDC	1,1 A	8,4 A	89 %	✓	215 x 115 x 30
RSP-320-12	320 W	10-13,2 VDC	2 A	26,7 A	88 %	✓	215 x 115 x 30
RSP-320-24	320 W	20-26,4 VDC	2 A	13,4 A	89 %	✓	215 x 115 x 30

RS..



LRS..

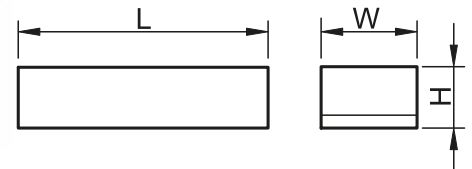

RSP..



LED szalagok



E/101-105

Műanyag házaz, védett LED meghajtók

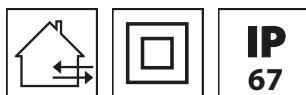

TRACON						$\eta\%$	L x W x H (mm)
LPH-18-12	18 W	180-264 VAC	12 VDC	0,3 A	1,5 A	77 %	140 x 30 x 22
LPH-18-24	18 W	180-264 VAC	24 VDC	0,3 A	0,75 A	77 %	140 x 30 x 22
LPV-20-12	20 W	90-264 VAC	12 VDC	0,35 A	1,67 A	81 %	118 x 35 x 26
LPV-20-24	20 W	90-264 VAC	24 VDC	0,35 A	0,84 A	83 %	118 x 35 x 26
LPV-35-12	36 W	90-264 VAC	12 VDC	0,7 A	3 A	84 %	148 x 40 x 30
LPV-35-24	36 W	90-264 VAC	24 VDC	0,7 A	1,5 A	85 %	148 x 40 x 30
LPV-60-12	60 W	90-264 VAC	12 VDC	1 A	5 A	83 %	163 x 43 x 32
LPV-60-24	60 W	90-264 VAC	24 VDC	1 A	2,5 A	86 %	163 x 43 x 32
LPV-100-12	100 W	90-264 VAC	12 VDC	1,5 A	8,5 A	85 %	190 x 52 x 37
LPV-100-24	100 W	90-264 VAC	24 VDC	1,5 A	4,2 A	88 %	190 x 52 x 37
LPV-150-12	120 W	180-305 VAC	12 VDC	1,7 A	10 A	87 %	191 x 63 x 38
LPV-150-24	150 W	180-305 VAC	24 VDC	1,7 A	6,3 A	89 %	191 x 63 x 38

LPH-18-12



LPV-20..

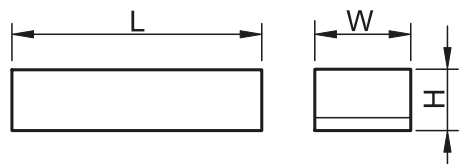

LPV-150..



Scharfer LED meghajtó

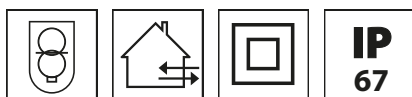

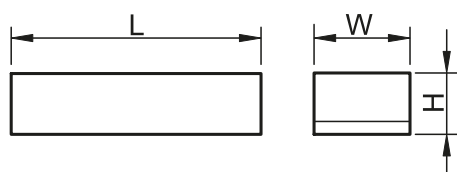

TRACON						$\eta\%$	L x W x H (mm)
SCH-18-12	18 W	185-250 VAC	12 VDC	0,13 A	1,5 A	83 %	162 x 28 x 20
SCH-30-12	30 W	185-250 VAC	12 VDC	0,27 A	2,5 A	85 %	162 x 29 x 21
SCH-45-12	45 W	185-250 VAC	12 VDC	0,42 A	3,75 A	85 %	190 x 29 x 21
SCH-60-12	60 W	185-250 VAC	12 VDC	0,43 A	5 A	86 %	222 x 29 x 21
SCH-100-12	100 W	170-250 VAC	12 VDC	0,9 A	8,33 A	90 %	218 x 40 x 22
SCH-150-12	150 W	200-250 VAC	12 VDC	1,45 A	12,5 A	87 %	279 x 57 x 25



Szerelvénydobozba építhető fényerő-szabályzó modulok

A szabályzó modulok segítségével a dimmelhető fényforrások, lámpatestek, LED szalagok vezérlése egyszerűen megoldható egy nyomógomb segítségével. A modulokat a nyomógomb mögé a szerelvénydobozba építve lehet elhelyezni. A ki-be kapcsolás a nyomógomb rövid megnyomásával végezhető el, a szabályzás a nyomógomb folyamatos nyomásával valósítható meg. A nyomógombok párhuzamos kapcsolásával a folyosói világítás fényerő-szabályzása is megoldható több helyről! Világító nyomógombok alkalmazásakor a nem kívánatos szivárgó áramok kiküszöbölhetők az ACDM003 kompenzátor alkalmazásával.

A LED szalagokhoz ajánlott vezérlő kizárólag egyszínű, 12-48 VDC feszültségű szalagokat képes szabályozni. A jelerősítő segítségével az egy csoportban vezérelendő szalagok hosszát lehet megnövelni.

TRACON			Nyomógombok száma	T _a 	L x W x H (mm)
REPLELE0	200 W	Triac LED	∞ (nem világító)	0 °C ... +40 °C	45 × 45 × 12
REPLELE1	350 W	Triac LED	∞ (3 db világító)	0 °C ... +40 °C	45 × 45 × 12
REPLALE2	8 A	Egyszínű LED szalag	∞ (nem világító)	0 °C ... +40 °C	46 × 46 × 24
AMPLALE2	8 A	Egyszínű LED szalag	–	0 °C ... +40 °C	45 × 42 × 12



REPLELE0



REPLELE1



REPLALE2



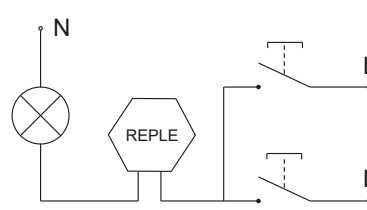
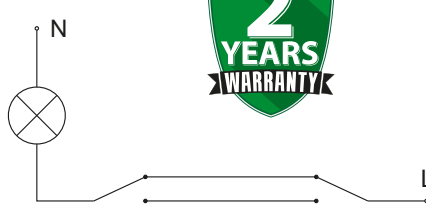
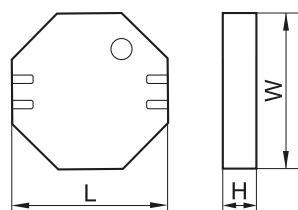

AMPLALE2



Vezeték nélküli vezérlőegységek világítási áramkörökhöz

A rendszer egy vevőegységből és egy vagy több adóegységből áll. Az adóegység lehet egy mozgásérzékelő vagy egy nyomógomb mögé szerelhető modul. Az adóegység működtető jele rádiófrekvencián (868,4 MHz) jut el a vevőig, mely relé vagy időzítő módban vezéri a lámpatest(ek)et.

TRACON		Vezérlő jellege	Jellemző	T _a 	L x W x H (mm)
DMSENR03	–	Mozgásérzékelő (elemes)	3-100 lx, 180°	-10 °C ... +40 °C	82 × 104 × 72
EMMIN001	–	Adó modul	–	0 °C ... +55 °C	55 × 53 × 34
MIPLAR01	400 W	Vevőegység	30 s – 10 min	0 °C ... +40 °C	45 × 40 × 13



DMSENR01



DMSENR03



EMMIN001



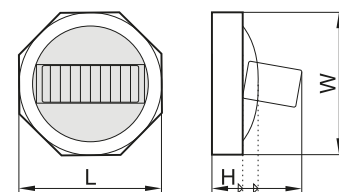

MIPLAR01



DIN sínre szerelhető fényerő-szabályzó modulok

Ezek a modulok elosztódobozba való szerelésre lettek kialakítva. Vezérlésük ugyancsak nyomógombokkal történik, a nagyobb fizikai méretek nagyobb terhelhetőséggel párosulnak.

TRACON			Nyomógombok száma	T _a 	L x W x H (mm)
REEL1LE1	350 W	Triac LED	∞ (3 db világító)	0 °C ... +40 °C	90 x 60 x 17,5
REEL5LE3	1000 W	Triac / 0-10 V LED	∞ (nem világító)	0 °C ... +40 °C	90 x 61 x 87,5
REEL2LE2	20 A	Egyszínű LED szalag	∞ (nem világító)	0 °C ... +55 °C	90 x 65 x 35
REEL5002	16 A	0-10 V LED (max. 250 mA)	∞ (nem világító)	0 °C ... +40 °C	90 x 61 x 87,5



REEL1LE1



REEL5LE3



REEL2LE2



REEL5002

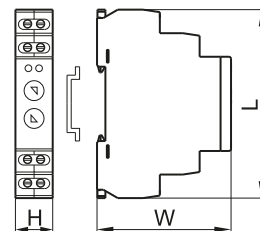
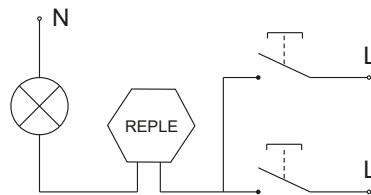
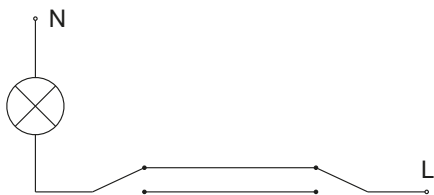

Kompenzátor

Világító nyomógombok alkalmazásakor a nem kívánatos szivárgó áramok kiküszöbölhetők az ACDM003 kompenzátor alkalmazásával.

TRACON

ACDM003

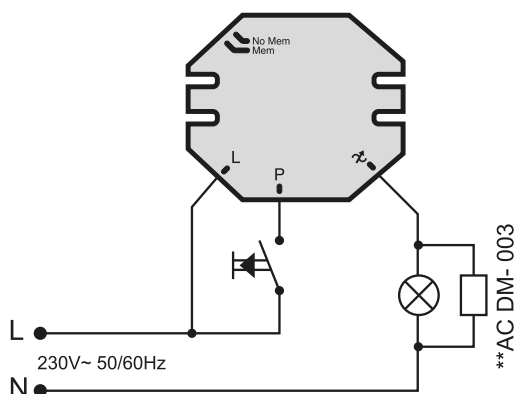

OLVASSA BE A KÓDOT!

- Nézze meg újdonságainkat
- Legyen naprakész

Kínálatunk gyorsan és folyamatosan fejlődik!
Katalógusunk a 2021. áprilisi állapotot tükrözi.
Naprakész információért látogasson el honlapunkra!



FIGYELEM!































**Megjelent különálló
Világítástechnika
katalógusunk!**

- 110 termékcsalád
- 800 termék
- Referenciák
- LED újdonságok
- QR kód minden termékénél
- Fénytechnikai laboratórium
- Világítástervezés
- Ulbricht-gömb





































**Keresse üzletkötőinknél
és a szakkereskedésekben!**



Táblázat fejlécek piktogramjai

 Hagyományos izzó kiváltás	 Kompakt fénycső kiváltás	 Fémhalogén kiváltás	 Halogén izzó kiváltás
 Fénycső kiváltás	 Kivágási méret (mm)	 Méretek (L x W x H), (D x L)	 Ajánlott oszlop magasság és átmérő (mm)
 Foglalat típusa	 Töltési idő	 Hangjelző	IP.. Védettségi fokozat
 Akkumulátor teljesítménye (Ah)	 Akkumulátor feszültsége (V)	 Akkumulátor típusa	η% Hatásfok
 Buratartó zárok száma (db)	 Sugárzási szög (°)	 Érzékelési szög	 Szín
In Névleges áram (A)	Un Névleges feszültség (V)	 Billenthető lámpatest	 Oldalsó védőérintkezős
 Fényáram (lumen)	 Színhőmérséklet (Kelvin)	 Névleges teljesítmény	 Energiahatékonysági osztály
 Kapcsolóval	 Átídalási idő (h)	 Megvilágítás (lux)	 LED-ek száma (db)
 Primer áram	 Maximális szekunder áram	 Szekunder feszültség	P_{max} Maximális terhelhetőség

Műszaki adatok piktogramjai

 Beltéri világításra alkalmas lámpatest	 Beltéri és kültéri világításra alkalmas lámpatest	 Kültéri világításra alkalmas lámpatest	 50/60 Hz Névleges frekvencia
 Mennezetre szerelhető lámpatest	 Oldalfalra szerelhető lámpatest	 Oldalfalra és mennyezetre szerelhető lámpatest	 Álmennyezetbe süllyeszthető lámpatest
 Nem alkalmazható fényerőszabályzóval	 Alkalmazható fényerőszabályzóval	 Élettartam 50.000	 ON-OFF Kapcsolások száma >30.000
 I. érintésvédelmi osztályú lámpatest	 II. érintésvédelmi osztályú lámpatest	 III. érintésvédelmi osztályú lámpatest	 Távirányító
 Beköthető vezeték keresztmetszet 2 x 1,5	 Beköthető vezeték 3 x 1,5mm² 30 cm	 Nem cserélhető a fényforrás	 Színvisszaadási index ≥80 Ra
90-265 V AC Névleges feszültség (V)	IP 65 Védettségi fokozat	 Ütésállóság IK08	 Az alkalmazható legnagyobb fényforrás átmérője 60 mm
 Biztonsági transzformátor	PFC Aktív teljesítménytényező szabályzás	 Elektronikus előtét EVG	 Magnetikus előtét VVG
 Vágható	 3 lépcsős fényerőszabályzás 12-50-100 %	 Káprázás UGR <19	 Felfutási idő T_{up} <1s
 Napelem	 Környezeti hőmérséklet T_a -5...+40 °C	 Beállítási időtartomány 10s-12min	 Sugárzási szög 250°
3-2.000 lux Megvilágítás (lux)	 Érzékelő	 Érzékelési szög 180°	 Mozgási sebesség 0,6...1,5m/s

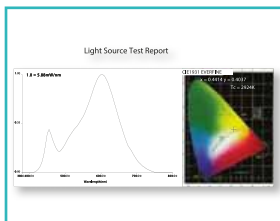

Fénytechnikai laboratórium 2

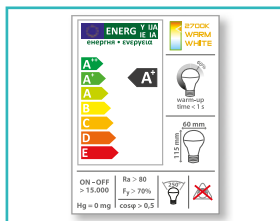

Fényforrások összehasonlító táblázata 3

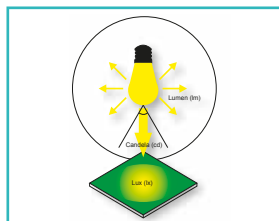

Világítástechnikai alapfogalmak 4



Normál gömb alakú LED fényforrások Samsung chippel 87



Gyertya és kis gömb alakú LED fényforrások SAMSUNG chippel 88



Opál búrás LED spot fényforrások SAMSUNG chippel 89



Opál búrás LED spot fényforrások 89



Normál gömb alakú LED fényforrások Samsung chippel 90



Gyertya alakú LED fényforrás 91



Kis gömb alakú LED fényforrások 91



Opál búrás LED spot fényforrások 92



Reflektor típusú LED fényforrások 92



3 lépésben fényerő-szabályozható fényforrások 93



LED fényforrás beépített mozgásérzékelővel 93



Ipari LED fényforrások 94



Beépíthető LED világító modul lámpatestekhez 95



LED fényforrás G9 foglalattal 96



LED fényforrás G4 foglalattal 97



Miniatur LED fényforrások E14 foglalattal 97



LED világító csövek 98



LED szalagok 101



LED szalag szettek 102



Miniatur LED vezérlő 102



RGB LED vezérlő 103



Jelerősítő RGB LED szalagokhoz 103



LED szalag kiegészítők 104



Alumínium profilok LED szalagokhoz 105



Végzáró lapok 105



Rugalmas rögzítő talp 105



Alumínium profilok (csomag változat) 105



Fémhalogén fényforrások 106



Kisméretű halogén izzólámpák 106



Reflektorlámpák 106



Fittámp 107



Fényforrás foglalal 107



Fényforrások összehasonlító táblázata

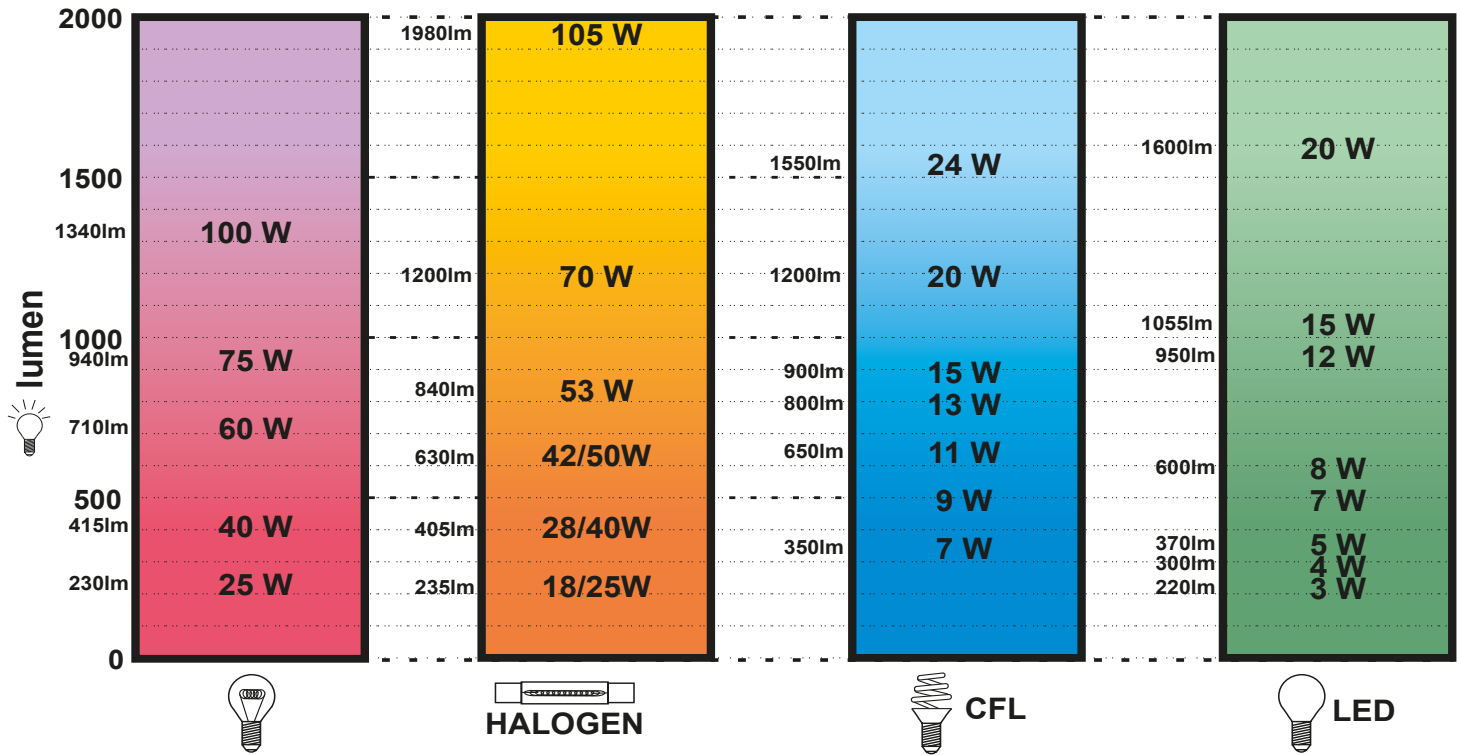

Jelmagyarázat

Energiacímke: LED fényforrásaink „A++”, „A+” és „A” energiahatékonysági osztályúak

warm-up time < 1s; 60%lm: a fényforrás bemelegedési ideje a teljes fényáram elérésének 60 %-áig

Ra: színvisszaadási index (100: természetes sugárzó)

ON-OFF: a kapcsolási ciklusok száma a korai meghibásodásig

Hg: a fényforrás higanytartalma

cosφ: lámpateljesítmény tényező

Fy: fényáram-stabilitási tényező az élettartam végén

250°: a névleges fénynyílásszög (sugárzási szög)

ENERGY LABEL: A+ efficiency, 2700K WARM WHITE color, warm-up time < 1s, 60%lm, 60mm diameter, 115mm height, ON-OFF > 15.000, Ra > 80, Fy > 70%, cosφ > 0,5, Hg = 0 mg, 250° beam angle, no mercury symbol.



Fényforrások foglaltai



Normál gömb alakú LED fényforrások Samsung chippel

230 V AC	50/60 Hz	25.000 [h]	SMD LED		$Ra \geq 80$	ON-OFF >15.000	Hg 0 mg	$T_{up} < 1s$	Piktogramok	E/5
-----------------	----------	------------	----------------	--	--------------	-------------------	------------	---------------	--------------------	------------

TRACON				LED		T_c [K]		D x L (mm)	
LGS455W	E27	5 W	40 W	380 lm	3.000 K	180°	45 x 78	A+	
LGS455NW	E27	5 W	40 W	400 lm	4.000 K	180°	45 x 78	A+	
LGS458W	E27	8 W	50 W	570 lm	3.000 K	180°	45 x 88	A+	
LGS458NW	E27	8 W	50 W	600 lm	4.000 K	180°	45 x 88	A+	
LAS607W	E27	7 W	60 W	600 lm	3.000 K	200°	60 x 108	A+	
LAS607NW	E27	7 W	60 W	630 lm	4.000 K	200°	60 x 108	A+	
LAS6010W	E27	10 W	75 W	940 lm	3.000 K	200°	60 x 112	A+	
LAS6010NW	E27	10 W	75 W	990 lm	4.000 K	200°	60 x 112	A+	
LAS6012W	E27	12 W	100 W	1.030 lm	3.000 K	200°	60 x 118	A+	
LAS6012NW	E27	12 W	100 W	1.080 lm	4.000 K	200°	60 x 118	A+	
LAS6515W	E27	15 W	150 W	1.280 lm	3.000 K	200°	65 x 129	A+	
LAS6515NW	E27	15 W	150 W	1.350 lm	4.000 K	200°	65 x 129	A+	
LGS12018W	E27	18 W	150 W	1.520 lm	3.000 K	270°	120 x 157	A+	
LGS12018NW	E27	18 W	150 W	1.600 lm	4.000 K	270°	120 x 157	A+	

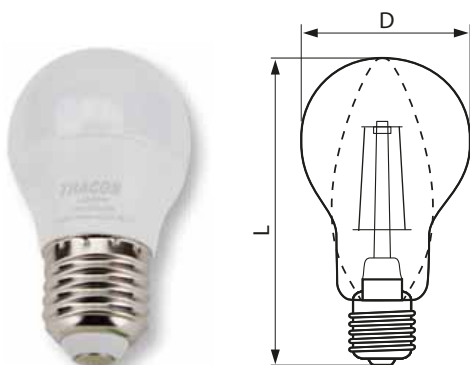

LGS455W

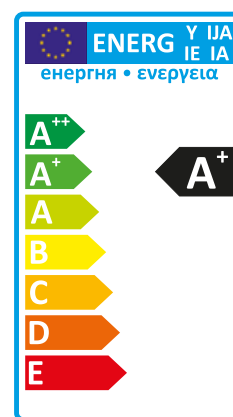

SAMSUNG LED Inside



LAS607NW



LGS12018NW

Gyertya és kis gömb alakú LED fényforrások SAMSUNG chippel



TRACON							D × L (mm)	
LGYS5W	E14	5 W	40 W	380 lm	3.000 K	180°	37 × 100	A+
LGYS5NW	E14	5 W	40 W	400 lm	4.000 K	180°	37 × 100	A+
LGYS7W	E14	7 W	50 W	530 lm	3.000 K	180°	37 × 100	A+
LGYS7NW	E14	7 W	50 W	560 lm	4.000 K	180°	37 × 100	A+
LGYS8W	E14	8 W	60 W	570 lm	3.000 K	180°	37 × 105	A+
LGYS8NW	E14	8 W	60 W	600 lm	4.000 K	180°	37 × 105	A+
LMGS455W	E14	5 W	40 W	380 lm	3.000 K	180°	45 × 78	A+
LMGS455NW	E14	5 W	40 W	400 lm	4.000 K	180°	45 × 78	A+
LMGS458W	E14	8 W	50 W	570 lm	3.000 K	180°	45 × 88	A+
LMGS458NW	E14	8 W	50 W	600 lm	4.000 K	180°	45 × 88	A+



LGYS5W, LGYS7W, LGYS8W



LMGS455W, LMGS455NW



LMGS458W, LMGS458NW

**SAMSUNG
LED Inside**

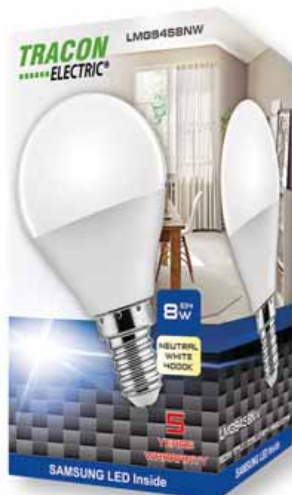
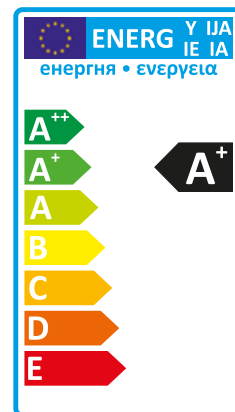
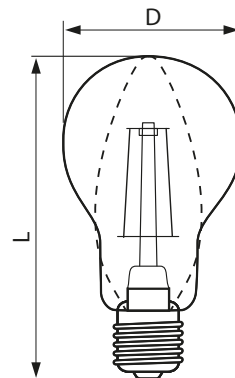

Opál búrás LED spot fényforrások SAMSUNG chippel



TRACON							D × L (mm)	
SMDSGU105W	GU10	5 W	35 W	380 lm	3.000 K	120°	50 × 55	A+
SMDSGU105NW	GU10	5 W	35 W	400 lm	4.000 K	120°	50 × 55	A+
SMDSGU105CW	GU10	5 W	35 W	420 lm	6.500 K	120°	50 × 55	A+
SMDSGU107W	GU10	7 W	50 W	530 lm	3.000 K	120°	50 × 55	A+
SMDSGU107NW	GU10	7 W	50 W	560 lm	4.000 K	120°	50 × 55	A+
SMDSGU107CW	GU10	7 W	50 W	580 lm	6.500 K	120°	50 × 55	A+
SMDSGU108W	GU10	8 W	70 W	570 lm	3.000 K	120°	50 × 55	A+
SMDSGU108NW	GU10	8 W	70 W	600 lm	4.000 K	120°	50 × 55	A+
SMDSGU108CW	GU10	8 W	70 W	620 lm	6.500 K	120°	50 × 55	A+

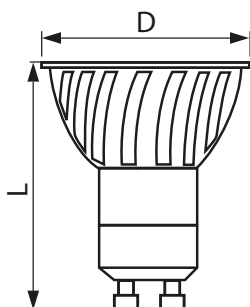
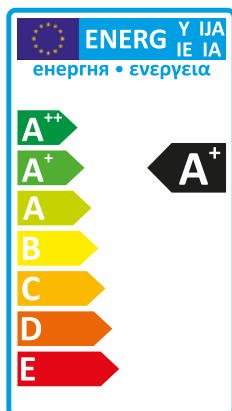

SAMSUNG LED Inside



SMDSGU107NW

Opál búrás LED spot fényforrások

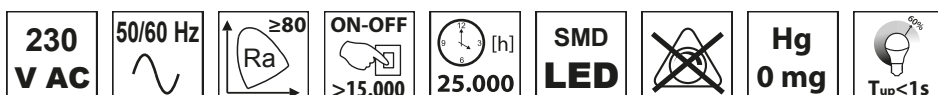

TRACON							D × L (mm)	
SMDGU1075YW	GU10	7 W	70 W	690 lm	3.000 K	120°	50 × 55	A+
SMDGU1075YNW	GU10	7 W	70 W	700 lm	4.000 K	120°	50 × 55	A+
SMDGU1075YCW	GU10	7 W	70 W	710 lm	6.500 K	120°	50 × 55	A+

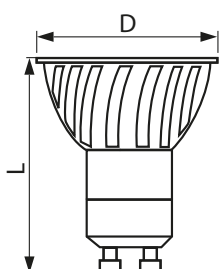
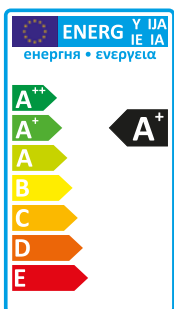

Normál gömb alakú LED fényforrások

TRACON							D x L (mm)	
LA555W	E27	5 W	40 W	400 lm	2.700 K	250°	55 x 105	A+
LA555NW	E27	5 W	40 W	400 lm	4.000 K	250°	55 x 105	A+
LA607W	E27	7 W	60 W	500 lm	2.700 K	250°	60 x 106	A+
LA607NW	E27	7 W	60 W	500 lm	4.000 K	250°	60 x 106	A+
LA6010W	E27	10 W	75 W	800 lm	2.700 K	250°	60 x 110	A+
LAD6010W*	E27	10 W	75 W	800 lm	2.700 K	250°	60 x 115	A+
LA6010NW	E27	10 W	75 W	800 lm	4.000 K	250°	60 x 110	A+
LAD6010NW*	E27	10 W	75 W	800 lm	4.000 K	250°	60 x 115	A+
LA6012W	E27	12 W	125 W	1.430 lm	3.000 K	250°	60 x 115	A+
LA6012NW	E27	12 W	125 W	1.450 lm	4.000 K	250°	60 x 115	A+
LA6015W	E27	15 W	150 W	1.620 lm	2.700 K	250°	60 x 110	A+
LA6015NW	E27	15 W	150 W	1.650 lm	4.000 K	250°	60 x 110	A+
LA6512W	E27	12 W	70 W	960 lm	2.700 K	250°	65 x 125	A+
LA6512NW	E27	12 W	100 W	1.000 lm	4.000 K	250°	65 x 125	A+
LA7015W	E27	15 W	150 W	1.200 lm	2.700 K	250°	70 x 135	A+
LA7015NW	E27	15 W	150 W	1.200 lm	4.000 K	250°	70 x 135	A+
LA8018W	E27	18 W	150 W	1.500 lm	2.700 K	250°	80 x 151	A+
LA8018NW	E27	18 W	150 W	1.500 lm	4.000 K	250°	80 x 151	A+

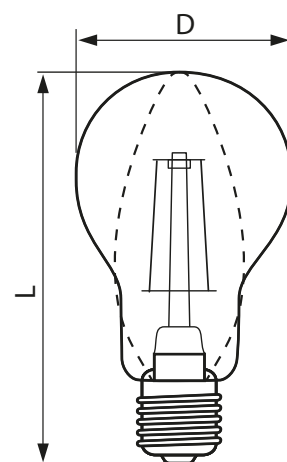
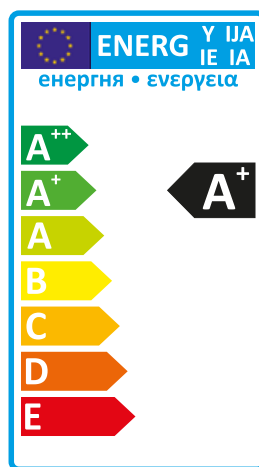

* dimmelhető

LED DISPLAY

kihelyezéssel
kapcsolatosan
érdeklődjön
képviselőinknél!

Gyertya alakú LED fényforrás



230 V AC	50/60 Hz				ON-OFF >15.000	SMD LED	Hg 0 mg	
-------------	----------	--	--	--	-------------------	------------	------------	--

TRACON					Tc [K]		D × L (mm)	
LGY5W	E14	5 W	40 W	370 lm	2.700 K	250°	37 × 97	A+
LGY5NW	E14	5 W	40 W	380 lm	4.000 K	250°	37 × 97	A+
LGY7W	E14	7 W	50 W	500 lm	2.700 K	250°	37 × 118	A+
LGY7NW	E14	7 W	50 W	500 lm	4.000 K	250°	37 × 118	A+
LGY8W	E14	8 W	60 W	570 lm	2.700 K	250°	37 × 118	A+
LGY8NW	E14	8 W	60 W	570 lm	4.000 K	250°	37 × 118	A+
LGYD6W*	E14	6 W	40 W	450 lm	2.700 K	250°	37 × 105	A+
LGYD6NW*	E14	6 W	40 W	450 lm	4.000 K	250°	37 × 105	A+
LGYF5W	E14	5 W	40 W	380 lm	2.700 K	250°	38 × 105	A+
LGYF5NW	E14	5 W	40 W	380 lm	4.000 K	250°	38 × 105	A+
LGYT5W	E14	5 W	40 W	370 lm	2.700 K	250°	38 × 106	A+

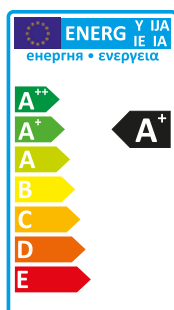
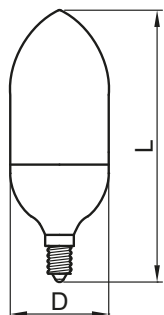

LGYF5W



LGY5..
LGY7..
LGY8..



LGYT5W

* dimmelhető

Kis gömb alakú LED fényforrások

230 V AC	50/60 Hz				ON-OFF >15.000	SMD LED	Hg 0 mg	
-------------	----------	--	--	--	-------------------	------------	------------	--

TRACON					Tc [K]		D × L (mm)	
LG454W	E27	4 W	20 W	250 lm	2.700 K	250°	45 × 80	A+
LG455W	E27	5 W	40 W	350 lm	2.700 K	250°	45 × 80	A+
LG455NW	E27	5 W	40 W	370 lm	4.000 K	250°	45 × 80	A+
LMG455W	E14	5 W	40 W	370 lm	2.700 K	250°	45 × 80	A+
LMG455NW	E14	5 W	40 W	380 lm	4.000 K	250°	45 × 80	A+
LMG457W	E14	7 W	40 W	500 lm	2.700 K	250°	45 × 85	A+
LMG457NW	E14	7 W	40 W	500 lm	4.000 K	250°	45 × 85	A+
LMG458W	E14	8 W	40 W	570 lm	2.700 K	250°	45 × 90	A+
LMG458NW	E14	8 W	40 W	570 lm	4.000 K	250°	45 × 90	A+

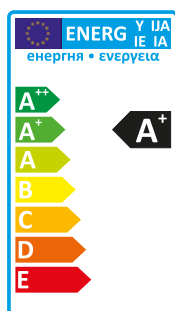
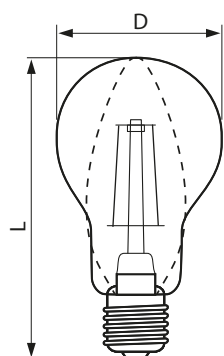

LMG45..



LG45..

Opál búrás LED spot fényforrások

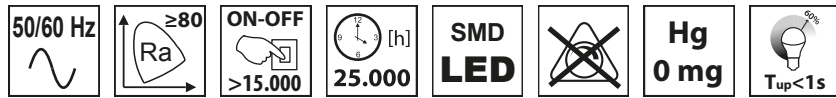

TRACON		U _n				T _c [K]		D × L (mm)	
SMDMR165W	G5.3	12 V AC/DC	5 W	35 W	300 lm	2.700 K	110°	50 × 48	A+
SMDMR165CW			5 W	35 W	300 lm	6.500 K	110°	50 × 48	A+
SMDMR165NW			5 W	35 W	300 lm	4.000 K	110°	50 × 48	A+
SMDGU105W	GU10	230 V AC	5 W	35 W	320 lm	2.700 K	120°	50 × 55	A+
SMDGU105NW			5 W	35 W	320 lm	4.000 K	120°	50 × 55	A+
SMDGU105CW			5 W	35 W	320 lm	6.000 K	120°	50 × 55	A+
SMDGU107W			7 W	50 W	450 lm	2.700 K	120°	50 × 55	A+
SMDGU107NW			7 W	50 W	450 lm	4.000 K	120°	50 × 55	A+
SMDGU107CW	7 W	50 W	450 lm	6.000 K	120°	50 × 55	A+		

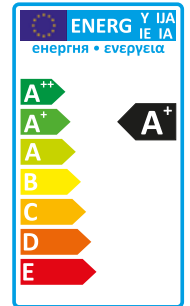
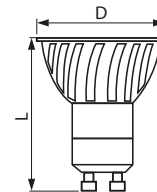

SMDGU.. SMDMR..

Reflektor típusú LED fényforrások

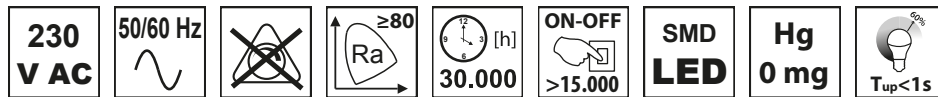

TRACON					T _c [K]		D × L (mm)	
LR507W	E14	7 W	40 W	470 lm	2.700 K	120°	50 × 86	A+
LR507NW	E14	7 W	40 W	470 lm	4.000 K	120°	50 × 86	A+
LR639W	E27	9 W	60 W	638 lm	2.700 K	120°	63 × 104	A+
LR639NW	E27	9 W	60 W	638 lm	4.000 K	120°	63 × 104	A+

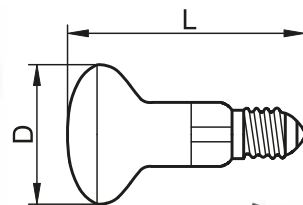

LR639W



LR507W



3 lépésben fényerő-szabályozható fényforrások

170-260 V AC	50/60 Hz	[h] 25.000	ON-OFF >15.000		≥ 80	SMD LED	Hg 0 mg	$T_{up} < 1s$	12-50-100 %	Piktogramok	E/5
------------------------	----------	---------------	--------------------------	--	-----------	----------------	----------------	---------------	----------------	--------------------	------------

TRACON	(W)		LED	[lm]	[K]	[°]	D x L (mm)	
LGY3D6W	6 W	E14	40 W	490 lm	3.000 K	250°	37 x 102	A+
LMG453D6W	6 W	E14	40 W	510 lm	3.000 K	250°	45 x 88	A+
LA603D12W	12 W	E27	75 W	1.055 lm	3.000 K	250°	60 x 121	A+

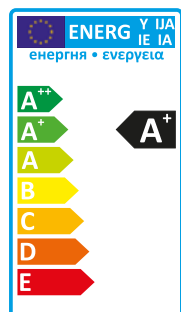
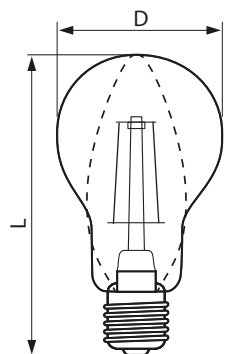

LA603D12W



LMG453D6W



LGY3D6W



LED fényforrás beépített mozgásérzékelővel

110-240 V AC	50/60 Hz	[h] 25.000	ON-OFF >15.000		≥ 80	SMD LED	Hg 0 mg	$T_{up} < 1s$
------------------------	----------	---------------	--------------------------	--	-----------	----------------	----------------	---------------

TRACON	(W)		LED	[lm]	[K]	[°]	[°]	D x L (mm)	
LA60M7NW	7 W	E27	60 W	600 lm	4.000 K	270°	360°	60 x 108	A+
LA60M7WW	7 W	E27	60 W	600 lm	2.700 K	270°	360°	60 x 108	A+

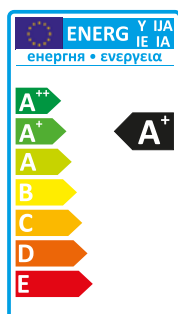
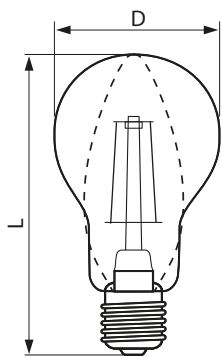

Nagyteljesítményű LED fényforrás SAMSUNG chippel

230 V AC	50/60 Hz		$Ra \geq 80$	[h] 30.000	ON-OFF >15.000	SMD LED	Hg 0 mg	60% T _{up} < 1s	T _a -15..+40°C
-------------	----------	--	--------------	---------------	-------------------	-------------------	------------	-----------------------------	------------------------------

TRACON				[lm]	T _c [K]	[°]	D × L (mm)	
LHPSE2720NW	E27	20 W	150 W	1.700 lm	4.000 K	200°	80 × 118	A+
LHPSE2730NW	E27	30 W	200 W	2.500 lm	4.000 K	200°	100 × 154	A
LHPSE2740NW	E27	40 W	350 W	3.500 lm	4.000 K	200°	118 × 171	A
LHPSE2750NW	E27	50 W	500 W	4.500 lm	4.000 K	200°	138 × 192	A



**SAMSUNG
LED Inside**

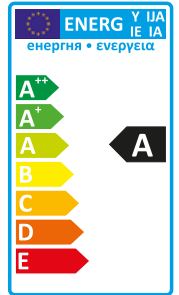
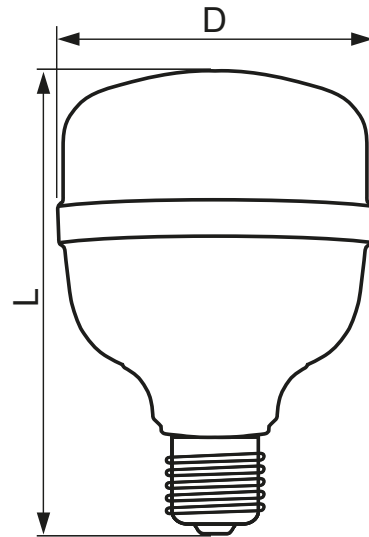

LHPSE2750NW

Nagyteljesítményű LED fényforrás

230 V AC	50/60 Hz		$Ra \geq 80$	[h] 30.000	ON-OFF >15.000	SMD LED	Hg 0 mg	60% T _{up} < 1s	T _a -15..+40°C	Piktogramok	E/5
-------------	----------	--	--------------	---------------	-------------------	-------------------	------------	-----------------------------	------------------------------	--------------------	------------

TRACON				[lm]	T _c [K]	[°]	D × L (mm)	
LHPE2720NW	E27	20 W	150 W	1.600 lm	4.000 K	270°	70 × 142	A
LHPE2725NW	E27	25 W	200 W	2.000 lm	4.000 K	270°	70 × 178	A
LHPE4040NW	E40	40 W	350 W	3.600 lm	4.000 K	270°	105 × 250	A

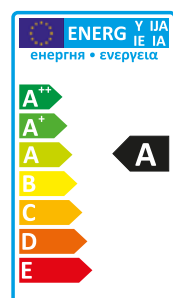
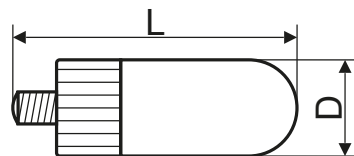

Nagyteljesítményű "magnólia" LED fényforrás

230 V AC	50/60 Hz		$Ra \geq 80$	30.000 [h]	ON-OFF >15.000	SMD LED	Hg 0 mg	$T_{up} < 1s$	Ta -15..+40°C
-------------	----------	--	--------------	------------	-------------------	------------	------------	---------------	------------------

TRACON			LED		Tc [K]	$[\circ]$	D x L (mm)	Ei
LHPME4050NW	E40	50 W	500 W	5.500 lm	4.000 K	300°	100 x 290	A+
LHPME4070NW	E40	70 W	600 W	7.700 lm	4.000 K	300°	121 x 305	A+

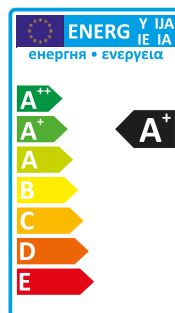
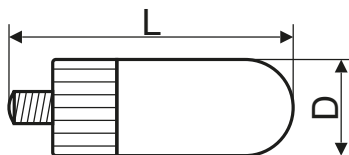

Beépíthető LED világító modul lámpatestekhez

230 V AC	50/60 Hz		$Ra \geq 80$	30.000 [h]	ON-OFF >30.000	SMD LED	Hg 0 mg	$T_{up} < 1s$
-------------	----------	--	--------------	------------	-------------------	------------	------------	---------------

TRACON		LED		Tc [K]	$[\circ]$	D (mm)	Ei
LLM9NW	9 W	75 W	630 lm	4.000 K	120°	Ø 125	A
LLM9WW	9 W	75 W	630 lm	2.700 K	120°	Ø 125	A
LLM18NW	18 W	150 W	1.260 lm	4.000 K	120°	Ø 180	A
LLM18WW	18 W	150 W	1.260 lm	2.700 K	120°	Ø 180	A

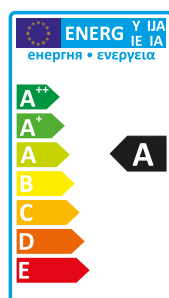

RELEVANT STANDARD
EN 60598



LED fényforrás G9 foglalattal

230 V AC	50/60 Hz				SMD LED	Hg 0 mg		ON-OFF >25.000
-----------------	----------	--	--	--	----------------	----------------	--	--------------------------

Piktogramok E/5

TRACON							D × L (mm)	Ei
LG93W	G9	3 W	15 W	200 lm	2.700 K	160°	18 × 55	A+
LG9H4W	G9	4 W	20 W	350 lm	2.700 K	200°	20 × 57	A++
LG9H4NW	G9	4 W	20 W	350 lm	4.000 K	200°	20 × 57	A++
LG9PC2,5W	G9	2,5 W	10 W	180 lm	2.700 K	300°	16 × 54	A+
LG9PC2,5NW	G9	2,5 W	10 W	180 lm	4.000 K	300°	16 × 54	A+
LG9X2,5W	G9	2,5 W	10 W	180 lm	2.700 K	270°	17 × 47	A+
LG9X2,5NW	G9	2,5 W	10 W	180 lm	4.000 K	270°	17 × 47	A+
LG9X3W	G9	3 W	15 W	350 lm	2.700 K	270°	18 × 49	A++
LG9X3NW	G9	3 W	15 W	350 lm	4.000 K	270°	18 × 49	A++



LED fényforrás G4 foglalattal

12 V AC/DC **50/60 Hz** **ON-OFF >30.000** **SMD LED** **Hg 0 mg**

Piktogramok E/5

TRACON							D × L (mm)	
LG41,5W	G4	1,5 W	5 W	100 lm	2.700 K	200°	10 × 35	A++
LG41,5NW	G4	1,5 W	5 W	100 lm	4.000 K	200°	10 × 35	A++
LG4H2,4W	G4	2,4 W	5 W	250 lm	2.700 K	200°	13 × 44,5	A++
LG4H2,4NW	G4	2,4 W	5 W	250 lm	4.000 K	200°	13 × 44,5	A++
LG4K2W	G4	2 W	10 W	140 lm	2.700 K	180°	20 × 32	A+
LG4K2NW	G4	2 W	10 W	140 lm	4.000 K	180°	20 × 32	A+
LG4X2W	G4	2 W	10 W	180 lm	2.700 K	270°	11 × 37	A++
LG4X2NW	G4	2 W	10 W	180 lm	4.000 K	270°	11 × 37	A++

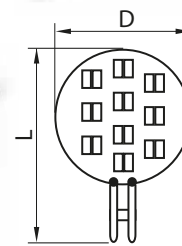
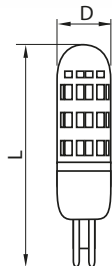
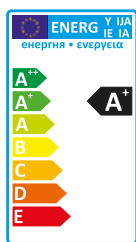

Miniatúr LED fényforrások E14 foglalattal

230 V AC **50/60 Hz** **ON-OFF >25.000** **SMD LED** **Hg 0 mg**



TRACON							D × L (mm)	
LH1,5WW	E14	1,5 W	5 W	110 lm	3.000 K	360°	16 × 50	A++
LH1,5NW	E14	1,5 W	5 W	110 lm	4.000 K	360°	16 × 50	A++
LH4W	E14	4 W	25 W	320 lm	2.700 K	360°	16 × 50	A+
LH4NW	E14	4 W	25 W	320 lm	4.000 K	360°	16 × 50	A+

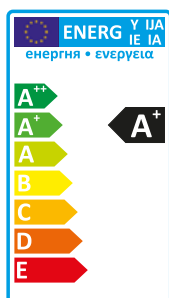
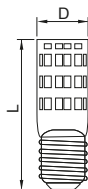

LED világító csövek

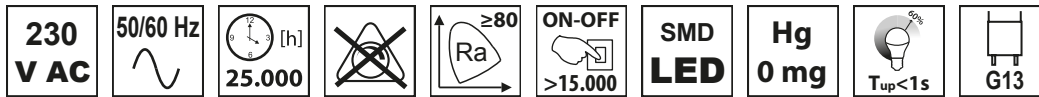

TRACON						D × L (mm)	
LT8G609CW	9 W	18 W	800 lm	6.500 K	200°	30 × 600	A+
LT8G609NW	9 W	18 W	800 lm	4.000 K	200°	30 × 600	A+
LT8G609WW	9 W	18 W	800 lm	2.700 K	200°	30 × 600	A+
LT8G12018CW	18 W	36 W	1.600 lm	6.500 K	200°	30 × 1200	A+
LT8G12018NW	18 W	36 W	1.600 lm	4.000 K	200°	30 × 1200	A+
LT8G12018WW	18 W	36 W	1.600 lm	2.700 K	200°	30 × 1200	A+
LT8G15022CW	22 W	58 W	1.900 lm	6.500 K	200°	30 × 1500	A+
LT8G15022NW	22 W	58 W	1.900 lm	4.000 K	200°	30 × 1500	A+
LT8G15022WW	22 W	58 W	1.900 lm	2.700 K	200°	30 × 1500	A+

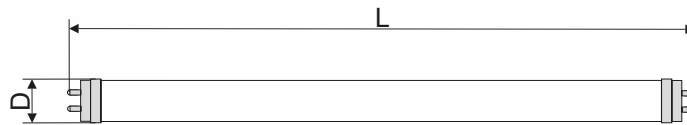
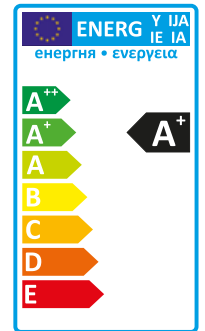

Bekötési rajz

Magnetikus előtétrel szerelt lámpatestek

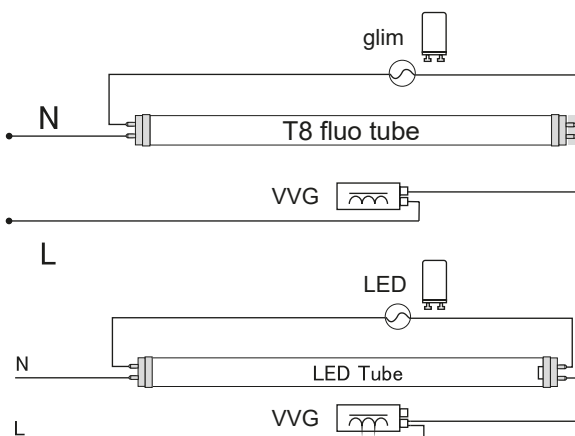

Elektronikus előtétrel szerelt lámpatestek

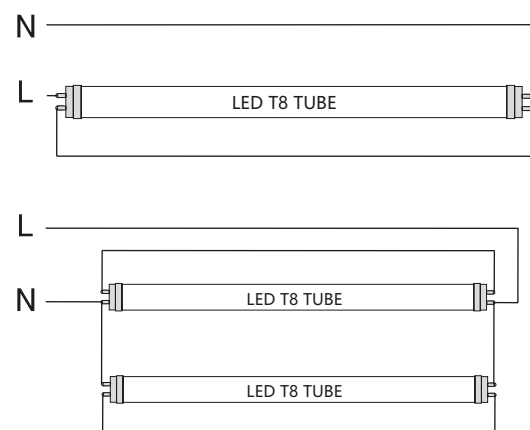

A LED technikával készített fénycsövek a hagyományos fénycsövek pótlására alkalmazhatók a lámpatest különösebb átalakítása nélkül.

Az elektronikus előtétrel szerelt lámpatestekbe a csövek egyéb kiegészítő alkatrész nélkül behelyezhetők (az elektronikus előtétet ki kell iktatni a hálózathoz és a csövet a jelölt oldalon közvetlenül kell megtáplálni).

A magnetikus előtétrel szerelt lámpatestekbe a gyújtó helyére egy speciális áthidaló alkatrészt kell helyezni, melyet a csövel együtt szállítunk.

A világító csövek egyoldali betáplálásúak.

Üveg LED világító cső, opál burás

230 V AC	50/60 Hz	25.000 [h]		$Ra \geq 80$	ON-OFF >15.000	SMD LED	Hg 0 mg	$T_{up} < 1s$	G13	
-----------------	----------	------------	--	--------------	----------------	----------------	----------------	---------------	-----	--

TRACON				T_c [K]	θ [°]	D x L (mm)		
LT8GH609WW	9 W	18 W	1.200 lm	3.000 K	200°	30x600	FIX	A++
LT8GH609NW	9 W	18 W	1.220 lm	4.000 K	200°	30x600	FIX	A++
LT8GH609CW	9 W	18 W	1.220 lm	6.500 K	200°	30x600	FIX	A++
LT8GH12018WW	18 W	36 W	2.350 lm	3.000 K	200°	30x1200	FIX	A+
LT8GH12018NW	18 W	36 W	2.450 lm	4.000 K	200°	30x1200	FIX	A+
LT8GH12018CW	18 W	36 W	2.450 lm	6.500 K	200°	30x1200	FIX	A+
LT8GH15022WW	22 W	58 W	2.900 lm	3.000 K	200°	30x1500	FIX	A+
LT8GH15022NW	9 W	22 W	3.000 lm	4.000 K	200°	30x1500	FIX	A+
LT8GH15022CW	22 W	58 W	3.000 lm	6.500 K	200°	30x1500	FIX	A+

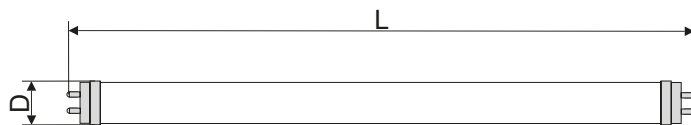
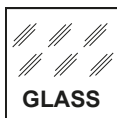
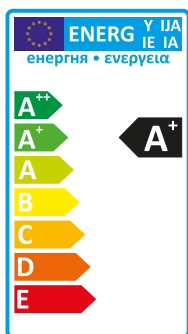

Bekötési rajz

Magnetikus előtétrel szerelt lámpatestek

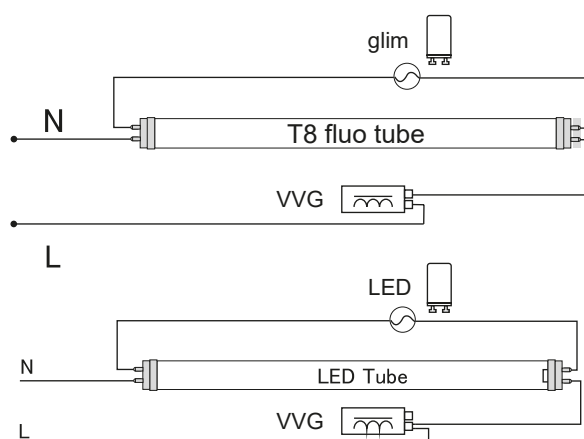

Elektronikus előtétrel szerelt lámpatestek

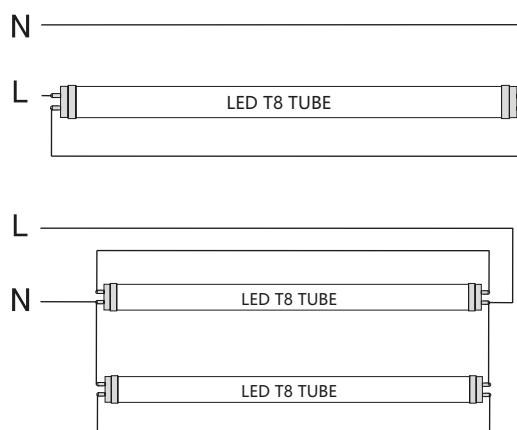

A LED technikával készített fénycsövek a hagyományos fénycsövek pótlására alkalmazhatók a lámpatest különösebb átalakítása nélkül.

Az elektronikus előtétrel szerelt lámpatestekbe a csövek egyéb kiegészítő alkatrész nélkül behelyezhetők (az elektronikus előtétet ki kell iktatni a hálózathoz és a csövet a jelölt oldalon közvetlenül kell megtáplálni).

A magnetikus előtétrel szerelt lámpatestekbe a gyújtó helyére egy speciális áthidaló alkatrészt kell helyezni, melyet a csövel együtt szállítunk.

A világító csövek egyoldali betáplálásúak.

IPARI AUTOMATIZÁLÁS

TRACON
.....**ELECTRIC®**



K/2-25

LED szalagok



TRACON						IP..	
LED-SZ-48-CW	4,8 W / m	200 lm / m	8 mm	6.000 K	100 mm	IP 20	60 × SMD3528 / m
LED-SZ-48-NW	4,8 W / m	180 lm / m	8 mm	4.000 K	100 mm	IP 20	60 × SMD3528 / m
LED-SZ-48-WW	4,8 W / m	180 lm / m	8 mm	3.000 K	100 mm	IP 20	60 × SMD3528 / m
LED-SZ-72-CW	7,2 W / m	320 lm / m	10 mm	6.000 K	100 mm	IP 20	30 × SMD5050 / m
LED-SZ-72-NW	7,2 W / m	320 lm / m	10 mm	4.000 K	100 mm	IP 20	30 × SMD5050 / m
LED-SZ-72-RGB	7,2 W / m	–	10 mm	RGB	100 mm	IP 20	30 × SMD5050 / m
LED-SZ-72-WW	7,2 W / m	320 lm / m	10 mm	3.000 K	100 mm	IP 20	30 × SMD5050 / m
LED-SZ-96-CW	9,6 W / m	400 lm / m	8 mm	6.000 K	50 mm	IP 20	120 × SMD3528 / m
LED-SZ-96-NW	9,6 W / m	360 lm / m	8 mm	4.000 K	50 mm	IP 20	120 × SMD3528 / m
LED-SZ-96-WW	9,6 W / m	360 lm / m	8 mm	3.000 K	50 mm	IP 20	120 × SMD3528 / m
LED-SZ-144-CW	14,4 W / m	560 lm / m	10 mm	6.000 K	50 mm	IP 20	60 × SMD5050 / m
LED-SZ-144-NW	14,4 W / m	560 lm / m	10 mm	4.000 K	50 mm	IP 20	60 × SMD5050 / m
LED-SZ-144-RGB	14,4 W / m	–	10 mm	RGB	50 mm	IP 20	60 × SMD5050 / m
LED-SZ-144-WW	14,4 W / m	530 lm / m	10 mm	3.000 K	50 mm	IP 20	60 × SMD5050 / m
LED-SZK-48-CW	4,8 W / m	200 lm / m	8 mm	6.000 K	100 mm	IP 65	60 × SMD3528 / m
LED-SZK-48-NW	4,8 W / m	180 lm / m	8 mm	4.000 K	100 mm	IP 65	60 × SMD3528 / m
LED-SZK-48-WW	4,8 W / m	180 lm / m	8 mm	3.000 K	100 mm	IP 65	60 × SMD3528 / m
LED-SZK-72-CW	7,2 W / m	330 lm / m	10 mm	6.000 K	100 mm	IP 65	30 × SMD5050 / m
LED-SZK-72-NW	7,2 W / m	320 lm / m	10 mm	4.000 K	100 mm	IP 65	30 × SMD5050 / m
LED-SZTR-72WW	7,2 W / m	300 lm / m	10 mm	3.000 K	100 mm	IP 65	30 × SMD5050 / m
LED-SZK-72-RGB	7,2 W / m	–	10 mm	RGB	100 mm	IP 65	30 × SMD5050 / m
LED-SZK-72-WW	7,2 W / m	300 lm / m	10 mm	3.000 K	100 mm	IP 65	30 × SMD5050 / m
LED-SZK-96-CW	9,6 W / m	360 lm / m	8 mm	6.000 K	50 mm	IP 65	120 × SMD3528 / m
LED-SZK-96-NW	9,6 W / m	360 lm / m	8 mm	4.000 K	50 mm	IP 65	120 × SMD3528 / m
LED-SZK-96-WW	9,6 W / m	360 lm / m	8 mm	3.000 K	50 mm	IP 65	120 × SMD3528 / m
LED-SZK-144-CW	14,4 W / m	640 lm / m	10 mm	6.000 K	50 mm	IP 65	60 × SMD5050 / m
LED-SZK-144-NW	14,4 W / m	620 lm / m	10 mm	4.000 K	50 mm	IP 65	60 × SMD5050 / m
LED-SZK-144-RGB	14,4 W / m	–	10 mm	RGB	50 mm	IP 65	60 × SMD5050 / m
LED-SZK-144-WW	14,4 W / m	600 lm / m	10 mm	3.000 K	50 mm	IP 65	60 × SMD5050 / m
LED-SZTR-144-CW	14,4 W / m	640 lm / m	10 mm	6.000 K	50 mm	IP 65	60 × SMD5050 / m

A LED szalagok elsősorban dekorációs felhasználásra készülnek, segítségükkel a dekorációs világítás könnyen, olcsón és egyszerűen valósítható meg a háztartásokban, boltokban és köztereken.

A 9,6 W/m és 14,4 W/m teljesítményű típusok garanciájának feltétele a szalagoknak alumínium sínbe való telepítése, mely a szalag megfelelő hűtését biztosítja. Az alumínium síneket lásd az E/105 oldalon.

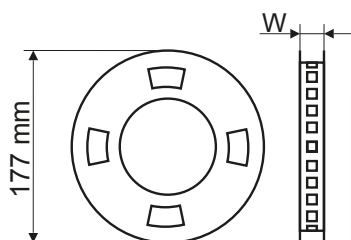

LED szalag szettek



TRACON							IP..
LED-SET-B-WW	4,8 W / m	120 lm / m	8 mm	3.000 K	100 mm	30 × SMD3528 / m	IP 20
LED-SET-K-RGB	14,4 W / m	450 lm / m	10 mm	RGB	50 mm	60 × SMD5050 / m	IP 54



A LED szalagjaink szettben is elérhetőek, melyek tartalmazzák a működtetéshez szükséges összes egységet, így szerelésük gyors és egyszerű. Fő technikai paramétereik megegyeznek a LED szalagokéval.



Miniatur LED vezérlő

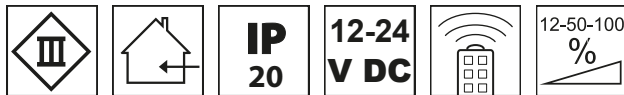

TRACON	U _n	I _n
LED-RF-2	12-24 VDC	12 A

Vezérlési módok

Rádiófrekvenciás távirányítóval: ki-be, fényerőszabályzás, előre programozott fényjátékok állítható sebességgel



Az egyszínű LED szalagok különböző előre programozott fényjátékok megjelenítésére alkalmasak a **LED-RF-2** vezérlő segítségével. A vezérlőt a megfelelően kiválasztott meghajtó 12-24 VDC áramkörébe a szalag és a meghajtó közé kell beszerelni.

Az egység rádiófrekvenciás távirányító segítségével vezérelhető. A rádiófrekvenciás technika miatt a távirányítónak nem kell rálátnia a vevőegységre. Egy vezérlővel maximum 5 m hosszú LED szalag kezelhető!



OLVASSA BE A KÓDOT!

- Nézze meg újdonságainkat
- Legyen naprakész

Kínálatunk gyorsan és folyamatosan fejlődik!
Katalógusunk a 2021. áprilisi állapotot tükrözi.

Naprakész információkért
látogasson el honlapunkra!

RGB LED vezérlő



TRACON	U_n			IP..
LED-RFRGB-144W	12-24 VDC	144 W	RGB	IP 20

A LED RGB szalagok különböző előre programozott színes fényjátékok megjelenítésére alkalmasak az LED-RF vezérlők segítségével. A vezérlőket a megfelelően kiválasztott meghajtó 12-24 VDC áramkörébe az RGB szalag és a meghajtó közé kell beszerezni. A vezérlők tartozéka a rádiófrekvenciás távirányító, amelynek segítségével az RGB vezérelhető. Egy vezérlővel maximum 5 m hosszú LED szalag kezelhető!

Hosszabb szalagok vezérléséhez jelerősítőt kell használni!



Jelerősítő RGB LED szalagokhoz



LPRGB

Az LPRGB jelerősítő segítségével a LED-RF vezérlő hatótávolsága megnövelhető, így újabb 5 m hosszú RGB szalagot lehet vezérelni az első szalag szakasszal megegyező módon. FIGYELEM! A jelerősítő külön 12 VDC tápellátást igényel!



E/80-83

LED szalag kiegészítők

TRACON	Csatlakozás módja	Jellemzők
LSZJF55	Csatlakozóelem egyszínű LED szalagok és meghajtó közé	5,5 mm-es JACK csatlakozó hüvely / csavaros csatlakozó
LSZJM55		5,5 mm-es JACK csatlakozó dugó / csavaros csatlakozó
LSZTC8	Egyszínű LED szalagok forrasztás nélküli csatlakoztatása toldó vezetékkel	8 mm széles szalagokhoz 15 cm vezetékkel
LSZTC10		10 mm széles szalagokhoz 15 cm vezetékkel
LSZTCRGRB	RGB LED szalagok forrasztás nélküli csatlakoztatása toldó vezetékkel	RGB szalagokhoz 15 cm vezetékkel
LSZT8	Egyszínű LED szalagok forrasztás nélküli csatlakoztatása	8 mm széles szalagokhoz
LSZT10		10 mm széles szalagokhoz
LSZTRGRB	RGB LED szalagok forrasztás nélküli csatlakoztatása	RGB szalagokhoz
LSZTL8	Forrasztás nélküli "L" gyorscsatlakozó egyszínű LED szalagokhoz	8 mm széles szalagokhoz (2P)
LSZTL10		10 mm széles szalagokhoz (2P)
LSZTLRGRB	Forrasztás nélküli "L" gyorscsatlakozó RGB LED szalagokhoz	10 mm széles szalagokhoz (4P)
LSZTT8	Forrasztás nélküli "T" gyorscsatlakozó egyszínű LED szalagokhoz	8 mm széles szalagokhoz (2P)
LSZTT10		10 mm széles szalagokhoz (2P)
LSZTTRGRB	Forrasztás nélküli "T" gyorscsatlakozó RGB LED szalagokhoz	10 mm széles szalagokhoz (4P)
LSZTX8	Forrasztás nélküli "X" gyorscsatlakozó egyszínű LED szalagokhoz	8 mm széles szalagokhoz (2P)
LSZTX10		10 mm széles szalagokhoz (2P)
LSZTXRGRB	Forrasztás nélküli "X" gyorscsatlakozó RGB LED szalagokhoz	10 mm széles szalagokhoz (4P)

A LED szalagok egyszerűbb szereléséhez különféle kiegészítő csatlakozók is elérhetők.

Segítségükkel a szalagokat forrasztás nélkül lehet egymáshoz toldani, illetve a szalagokat a meghajtókhoz csatlakoztatni.

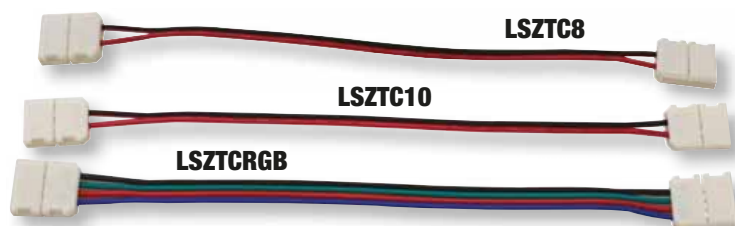

LSZTXRGRB



LSZJF55



LSZTRGRB



LSZT8,
LSZT10



LSZJM55



Alumínium profilok

A LED szalagok optimális működéséhez és a hosszú élettartam biztosításához az alumínium LED profilok alkalmazását ajánljuk. A profilok segítségével a szalagoknak nemcsak a hűtése biztosított, de megjelenésük is esztétikusabb, környezetükhöz jobban illeszkedő. A termékek IP20-as védelemmel rendelkeznek, ezért a beléjük szerelt beltéri szalagokat nem teszik kültéri alkalmazásra alkalmassá! A termék méteres szalagban kapható. A profilok alján furatok nem találhatóak a méretre vágás megkönnyítése érdekében, ezeket a szerelés során az adott helyhez illesztve kell a felhasználónak kifúrni. A szalagot a profil alá kell behelyezni, a takaró bura a profil belső részébe csúsztható.



TRACON	$\frac{W}{\text{mm}}$	$\frac{L}{\text{m}}$				
LEDSZSLIM	8 mm	1 m	LEDSZBSLO	-	VLSLIM	RLSL
LEDSZTRIO	10 mm	1 m	LEDSZBCTO	LEDSZBCTT	VLTRIO	-
LEDSZSURFACE	10 mm	1 m	LEDSZBCTO	LEDSZBCTT	VLSURFACE	RLSUCO
LEDSZCORNER	10 mm	1 m	LEDSZBCTO	LEDSZBCTT	VLCORNER	RLSUCO

Alumínium profilok (csomag változat)

TRACON	H (mm)	W1 (mm)	W2 (mm)	$\frac{L}{\text{m}}$
LEDSZK	8.7	12.5	14.8	1 m
LEDSZPS10	7	12.4	17.4	1 m
LEDSZPS8	6.7	12	15.8	1 m
LEDSZPR	7.9	13.1	17.6	1 m
LEDSZPC	15.5	12.28	15.5	1 m

A cikkszám tartalmazza: alumínium profil, opál bura, végelezárók, rögzítők.

Minimális rendelési mennyiség: 5

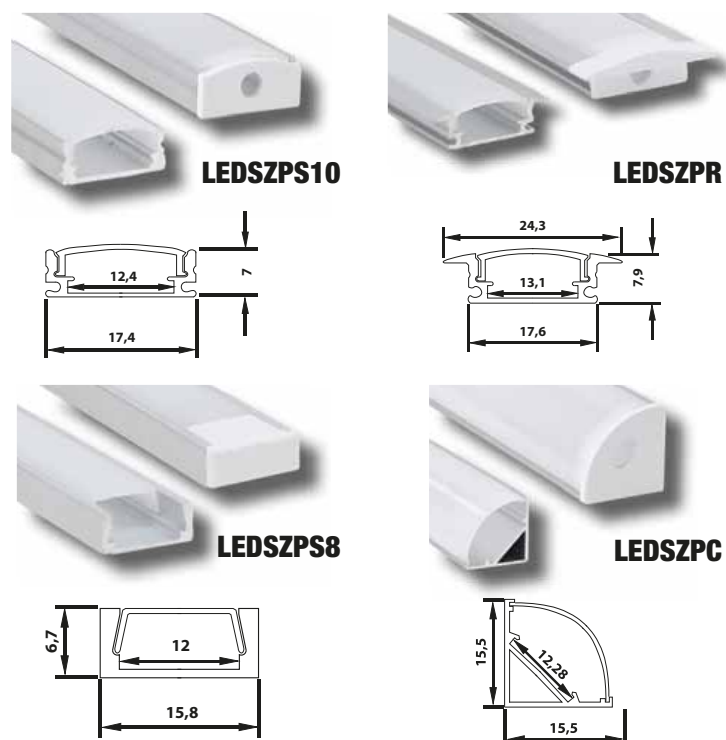
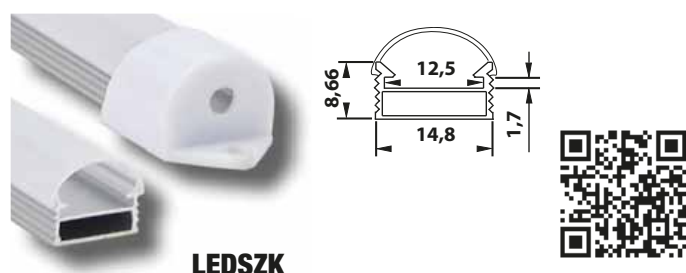

Fémhalogén fényforrások

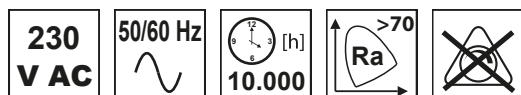

TRACON			L (mm)	W (mm)	Tc [K]		
FHL-R7S-70W	R7XS	70 W	120	20	6.000 K	5.600 lm	A
FHL-R7S-150W	R7XS	150 W	138	23	6.000 K	11.250 lm	A
FHL-E27-70W	E27	70 W	141	55	6.000 K	5.600 lm	A
FHL-E27-150W	E27	150 W	141	55	6.000 K	11.250 lm	A
FHL-E40-250W	E40	250 W	257	46	6.000 K	20.500 lm	A
FHL-E40-400W	E40	400 W	283	46	6.000 K	38.000 lm	A

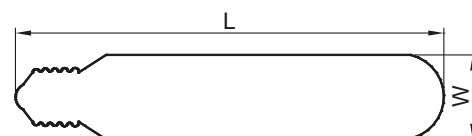

Kisméretű halogén izzólámpa



TRACON				ON-OFF	Tc [K]	D (mm)	L (mm)	pcs	
TLWI-G9-60-F	60 W	G9	2.000 h	>2.000	2.700 K	14	40	x 3	F

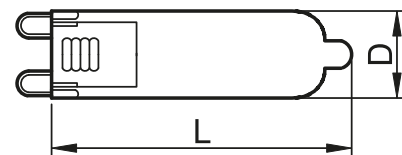

Reflektorlámpák



TRACON				ON-OFF	Tc [K]	D (mm)	L (mm)	
TLRL-R50-E14-25-F TLRL-R50-E14-25	25 W	E14	1.000 h	>2.000	2.700 K	50	85	F

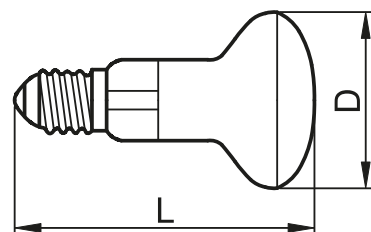

TLRL-R50-E14-25-F

TLRL-R50-E14-25

Fitlamp

230 V AC	50/60 Hz		Ra ≥80	 T _{up} < 60s	Hg < 2,5 mg
-------------	----------	--	--------	---------------------------	----------------

Piktogramok **E/5**

TRACON				T _c [K]	I _n			D (mm)	L (mm)	
FL18	E27	18 W	1.070 lm	2.700 K	150 mA	6.000 h	>8.000	55	99	A

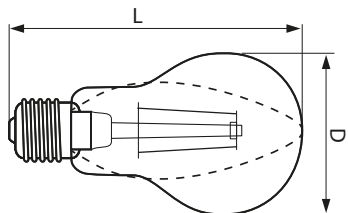

Kerámiafoglatat törpefeszültségű fényforrásokhoz

100-240 V AC		
-----------------	--	--

TRACON			
TG-5.5	G5.3	MR11, MR16	100 mm

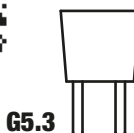

Kerámiafoglatat 230 V-os fényforrásokhoz

230 V AC	
-------------	--

TRACON		
TGU-10	GU10	100 mm



Hálózati adapter GU10 fényforrásokhoz

230 V AC			
-------------	--	--	--

TRACON		
TAGU-10	GU10	50 W

Alkalmazásával lehetőségünk nyílik 230 V-os hidegtükrös fényforrásoknak a beépítésre szánt lámpatestbe való szabványos alkalmazására. A tápellátás vezetőit az adapter csavaros csatlakozókapcsaiba kell bekötni, és a tehermentesítő bilincssel kell rögzíteni. Az adapter a lámpatest rugóelemének segítségével rögzíthető a házhoz.

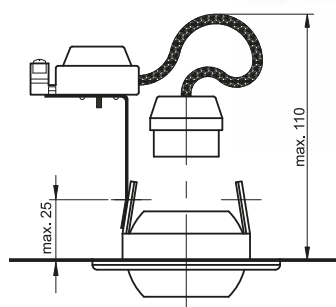





















RELEVANT STANDARD
EN 60061

Táblázat fejlécek piktogramjai

 Megjegyzés, kiegészítés	 Áthidalási idő (h)	 Szín	 Nyomógomb áramkör hossza
 I_{imptotal} 10/350 μs Teljes villámáram levezető képesség	I_n Névleges áram (A)	 $\times \frac{L}{D}$ LED-ek száma (db)	IP.. Védettségi fokozat
U_p Feszültségvédelmi szint	 I_{imp} $\frac{1P}{10/350\mu\text{s}}$ Villámáram levezető képesség	U_n Névleges feszültség (V)	I_n $\frac{L-N}{8/20\mu\text{s}}$ Névleges működési áram
I_{cn} EN60698 Kismegszakítók névleges üzemi zárlati megszakítóképessége	U_c Maximális folyamatos üzemi feszültség	I_{max} 8/20 μs Maximális levezetési áram	 H L W Méretek (L×W×H)
$I_{\Delta n}$ (mA) Névleges kioldási hibaáram	I_e Névleges üzemi áram	U_m Névleges működtető feszültség	 mm ² Beköthető vezeték-kérsztszmetzet
U_{up} Felső feszültségvédelmi szint	P_{max} Névleges teljesítmény	P_s Saját teljesítmény-felvétel	 NC NO CO Érintkezők
$\times P$ Pólusszám	U_{down} Alsó áramvédelmi szint	 C Kioldási jelleggörbe	 Csapófedeles aljzat
I_{sec} Maximális szekunder áram	$\times 17.5$ Modulok száma	 Kismegszakító bal oldala	Σ Alkalmazható nyomógombok száma
 Oldalsó védőérintkezős	U_{sec} Szekunder feszültség	U_{pr} Primer feszültség	 Golyóscsapágó
 Hálózati rendszer	 Csapos védőérintkezős	 Normál aljzat	 Hátsó pillangó zsalu

Műszaki adatok piktogramjai

230 V AC Névleges feszültség (V)	50/60 Hz Névleges frekvencia	 ON-OFF-ON... sc/h $\times 3.600$ Kapcsolási gyakoriság	IP 54 Védettségi fokozat
 Hangerő	 rel % 30-90 Relatív páratartalom	T_a -40...+105 °C Környezeti hőmérséklet	low batt Alacsony elemfeszültség kijelzés
 Cserélhető betét	 Egybeépített	 -AUX 1×NO Segédérintkezők	[mm²] 0,75-2,5 Beköthető vezeték
Ft Hőbiztosító	 Szikraköz	 Varisztor	 Optikai jelző
63 A gG Javasolt előtétbiztosító	I_2t 3 Energiahatékonysági osztály	E3 Energiahatékonysági osztály	R $\geq 0.5m\Omega$ Ellenállás
LCD LCD kijelzős mérőműszer	 II. érintésvédelmi osztály	AC Váltakozó áramú hálózatokra	A, AC Váltakozó áramú és lüktető egyenáramú hálózatokra
U_{imp} 6 kV Névleges lökfeszültség-állóság	 U_i 690 V Névleges szigetelési feszültség	 Villamos élettartam $\times 10.000$	 Mechanikai élettartam $\times 10.000$
I_{cn} EN60698 10 kA Kismegszakítók névleges üzemi zárlati megszakítóképessége	 Oldalfalra szerelhető	P_m 0,8 W Saját teljesítményfelvétel	 Élettartam 20.000 [h]
 0-1-2 állásban zárópecsételhető	 OFF KI állásban zárópecsételhető	8mm Érintkezők közötti távolság	V0 UL94 Lángállóság UL94 szerint
 Szerelősínre szerelhető 35×7.5	 A készülékek csapos sorolósínekkel szerelhetők	 A készülékek csapos és/vagy villás sorolósínekkel szerelhetők	 Kioldó típusa: Termomágneses



1+2. típusú
túlfeszültség-levezetők **4**



2. típusú
túlfeszültség-levezetők **5**



1+2+3. típusú
túlfeszültség-levezetők **6**



3. típusú
túlfeszültség-levezetők **7**



1+2. és 2. típusú DC
túlfeszültség-levezetők **7**



2+3 típusú túlfeszültség-levezető (LED meghajtóhoz) **11**



EVOZ kismegszakítók **16**



EVOTDA kismegszakító **17**



EVOH nagyáramú
túlárámvédelmi megszakítók **18**



EVON (1+N pólusú)
kismegszakító **19**



EVOK kombinált
védőkapcsolók **20**



EVOV
áram-védőkapcsolók **21**



EVOTIK
leválasztó kapcsolók **23**



EVOSVK sorolható
váltókapcsolók **24**



EVOMS sorolható, lakatolható
szakaszoló kapcsoló **25**



EVOSLJL jelzőlámpák **25**



EVOP moduláris nyomógomb,
nyomókapcsoló **26**



EVOBT biztonsági (csengő)
transzformátor **26**



EVOHK Installációs
kontaktorok **27**



Feszültségfigyelő relé **28**



MB kismegszakítók **31**



TDZ kismegszakítók **32**



DC kismegszakítók egyenáramú
villamos hálózatokhoz **33**



KVK kombinált áramvédő
kapcsolók **35**



RB áram-védőkapcsolók **36**



Áram-védőkapcsoló, motoros automata
visszkapcsoló készülékkel **39**



Lépcsőházi időkapcsoló **41**



Impulzusrelék **42**



Jelzőcsengők **42**



Sorolható csatlakozóaljzat **43**



Falon kívüli kapcsolók és csatlakozóaljzatok, TR-PH típus **44**



Süllyesztett csatlakozóaljzat
USB porttal **46**



Vezeték nélküli csengő **47**



Szén-monoxid érzékelő **50**



Vezeték nélküli füstérzékelő
átjelzési lehetőséggel **51**

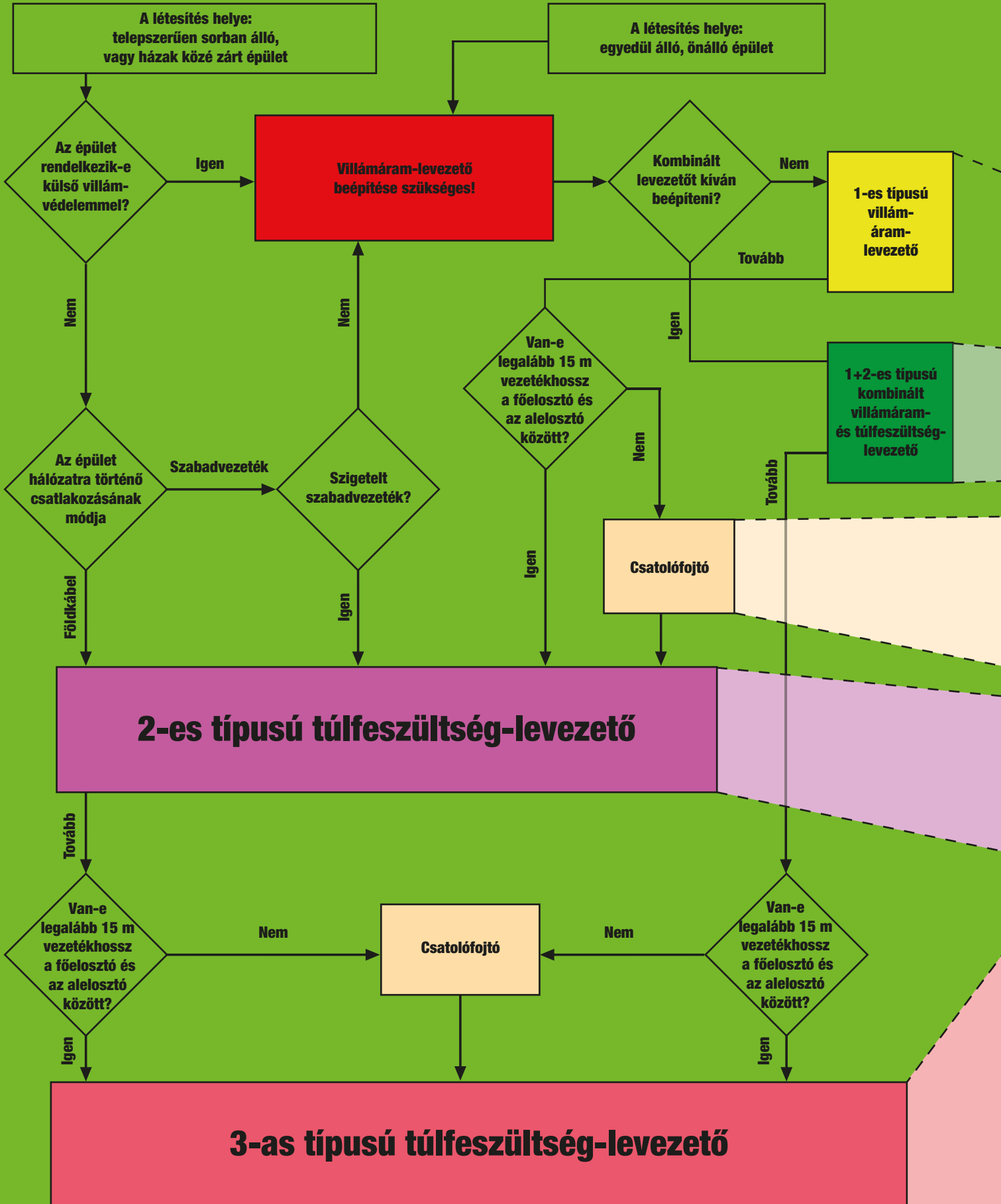

Kiválasztási segédlet

A megfelelő villám- és túlfeszültségvédelmi rendszer megtervezésekor, annak összetettsége miatt mindenképpen ajánljuk, hogy azt minden felhasználó, szakember segítségével végezze el!

A tervezéshez segítséget nyújt a mellékelt folyamatábra, amelyet végig követve a rendszer építőelemei kiválaszthatók az erősáramú hálózat védelméhez.

A folyamatábrát a telepítés helyének megfelelő kockából kell indítani és minden esetben a 3-as típusú levezetőig kell folytatni. A minimális védelemhez legalább a 2-es és 3-as típusú levezetőnek beépítésre kell kerülnie!

Az 1-es és 1+2-es típusú levezetők általános telepítési helye az épületek főelosztója, a 2-es és 3-as típusú levezetőket az alelosztóba ajánljuk telepíteni. Amennyiben a 3-as típus és a védendő berendezés között több, mint 30 m a betápláló vezeték hossza, akkor a 3-as típusú védelmet a készülék csatlakozásánál meg kell ismételni! A gyengeáramú rendszerek védelméhez a kiegészítő védelemmel ellátott hosszabbító sávjainkat ajánljuk. További részletes leírás a függelékben.

Csatolófojtó**F/11****DC túlfeszültség-levezetők****F/7****1+2. típusú túlfeszültség-levezetők****F/4****1+2+3. típusú túlfeszültség-levezetők****F/6****2. típusú túlfeszültség-levezetők****F/5****2+3. típusú túlfeszültség-levezetők****F/6****3. típusú túlfeszültség-levezetők****F/7****Többférőhelyes védett elosztósávok****G/11-G/12**

1+2. típusú túlfeszültség-levezetők

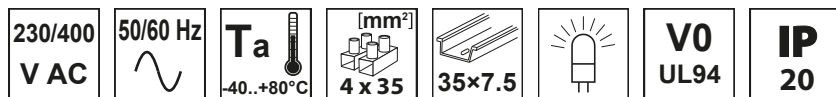

TRACON	xP	U _c	I _{imp} L-N/(N-PE)1P 10/350µs	I _n L-N/(N-PE) 8/20µs	I _{max} 8/20µs	U _p L-N/(N-PE)	gG	W (mm)
ESPD1+2-50-1P	1P	385 V AC	50 kA	50 kA	160 kA	≤ 2,5 kV	500 A	TN 36
ESPD1+2-50-2P	2P	385 V AC	50 kA	50 kA	160 kA	≤ 2,5 kV		TN 72
ESPD1+2-50-3P	3P	385 V AC	50 kA	50 kA	160 kA	≤ 2,5 kV		TN-C 108
ESPD1+2-50-4P	4P	385 V AC	50 kA	50 kA	160 kA	≤ 2,5 kV		TN-S 144
ESPD1+2-50-1+1P	1+1P	385 V AC	50 kA / 100 kA	50 kA / 100 kA	160 kA / 200 kA	≤ 2,5 kV		TN, TT 72
ESPD1+2-50-3+1P	3+1P	385 V AC	50 kA / 100 kA	50 kA / 100 kA	160 kA / 200 kA	≤ 2,5 kV		TN-S, TT 144
ESPD1+2-12.5-1P	1P	275 V AC	12,5 kA	20 kA	50 kA	≤ 1,3 kV	160 A	TN 18
ESPD1+2-12.5-2P	2P	275 V AC	12,5 kA	20 kA	50 kA	≤ 1,3 kV		TN 36
ESPD1+2-12.5-3P	3P	275 V AC	12,5 kA	20 kA	50 kA	≤ 1,3 kV		TN-C 54
ESPD1+2-12.5-4P	4P	275 V AC	12,5 kA	20 kA	50 kA	≤ 1,3 kV		TN-S 72
ESPD1+2-12.5-1+1P	1+1P	275 V AC	12,5 kA	20 kA / 40 kA	50 kA / 70 kA	≤ 1,3 kV / 1,5 kV		TN, TT 36
ESPD1+2-12.5-3+1P	3+1P	275 V AC	12,5 kA	20 kA / 40 kA	50 kA / 70 kA	≤ 1,3 kV / 1,5 kV		TN-S, TT 72
ESPD1+2-12.5M*	1P	275 V AC	12,5 kA	20 kA	50 kA	≤ 1,3 kV	TN 18	
ESPD1+2-12.5NPE*	+1P	275 V AC	12,5 kA	40 kA	70 kA	≤ 1,5 kV	TN, TT 18	

* cserélhető betétek

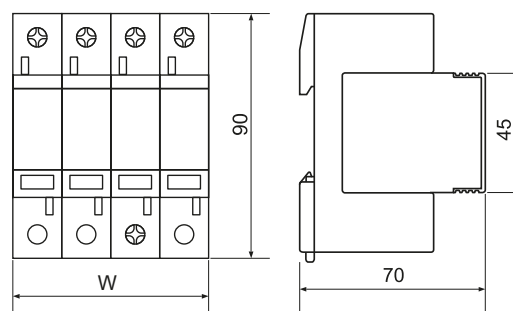
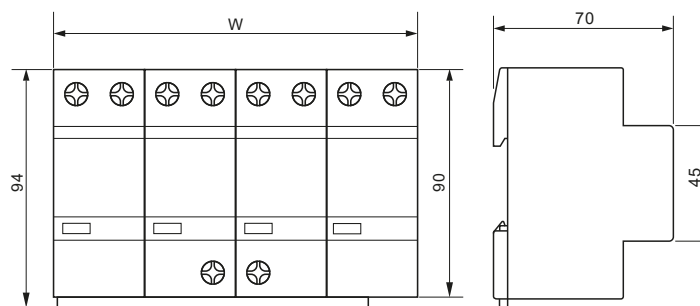

OLVASSA BE A KÓDOT!

- Nézze meg újdonságainkat
- Legyen naprakész

Kínálatunk gyorsan és folyamatosan fejlődik!
Katalógusunk a 2021. áprilisi állapotot tükrözi.
Naprakész információért látogasson el honlapunkra!

2. típusú túlfeszültség-levezetők

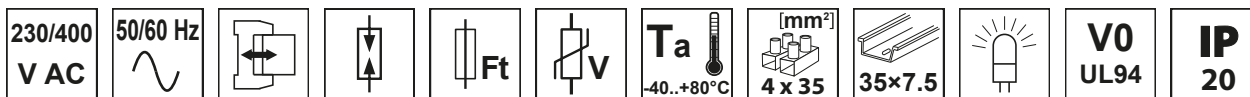

TRACON	xP	U _c	I _n L-N/(N-PE) 8/20µs	I _{max} 8/20µs	U _p L-N/(N-PE)	gG	W (mm)
ESPD2-40-1P	1P	275 V AC	20 kA	40 kA	≤ 1,3 kV	125 A	TN 18
ESPD2-40-2P	2P	275 V AC	20 kA	40 kA	≤ 1,3 kV		TN 36
ESPD2-40-3P	3P	275 V AC	20 kA	40 kA	≤ 1,3 kV		TN-C 54
ESPD2-40-4P	4P	275 V AC	20 kA	40 kA	≤ 1,3 kV		TN-S 72
ESPD2-40-1+1P	1+1P	275 / 255 V AC	20 kA	40 kA	≤ 1,3 kV / 1,5 kV		TN, TT 36
ESPD2-40-3+1P	3+1P	275 / 255 V AC	20 kA	40 kA	≤ 1,3 kV / 1,5 kV		TN-S, TT 72
ESPD2-40M*	1P	275 V AC	20 kA	40 kA	≤ 1,3 kV	200 A	TN 18
ESPD2-40NPE*	+1P	255 V AC	20 kA	40 kA	≤ 1,5 kV		TN, TT 18
ESPD2-70-1P	1P	275 V AC	40 kA	70 kA	≤ 1,7 kV		TN 18
ESPD2-70-2P	2P	275 V AC	40 kA	70 kA	≤ 1,7 kV		TN 36
ESPD2-70-3P	3P	275 V AC	40 kA	70 kA	≤ 1,7 kV		TN-C 54
ESPD2-70-4P	4P	275 V AC	40 kA	70 kA	≤ 1,7 kV		TN-S 72
ESPD2-70-1+1P	1+1P	275 / 255 V AC	40 kA	70 kA	≤ 1,7 kV / 1,5 kV	200 A	TN, TT 36
ESPD2-70-3+1P	3+1P	275 / 255 V AC	40 kA	70 kA	≤ 1,7 kV / 1,5 kV		TN-S, TT 72
ESPD2-70M*	1P	275 V AC	40 kA	70 kA	≤ 1,7 kV		TN 18
ESPD2-70NPE*	+1P	255 V AC	40 kA	70 kA	≤ 1,5 kV		TN, TT 18

* cserélhető betétek

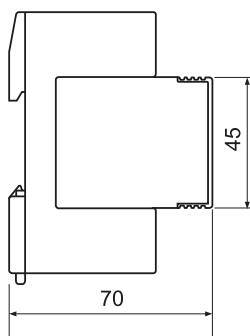
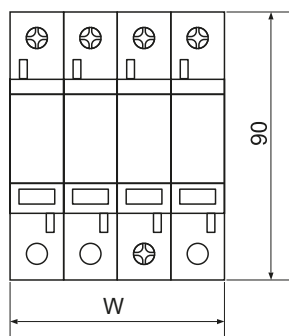

OLVASSA BE A KÓDOT!

- Nézze meg újdonságainkat
- Legyen naprakész

Kínálatunk gyorsan és folyamatosan fejlődik!
Katalógusunk a 2021. áprilisi állapotot tükrözi.
Naprakész információért
látogasson el honlapunkra!

2+3. típusú túlfeszültség-levezetők

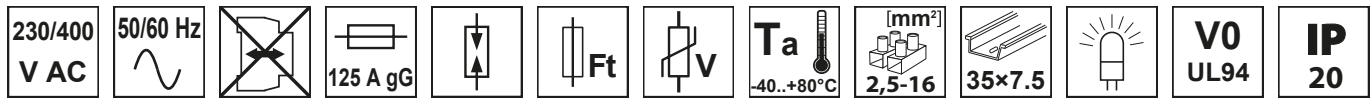

TRACON	xP	U _c	I _n L-N/(N-PE) 8/20μs	I _{max} 8/20μs	U _{oc}	U _p L-N/(N-PE)		W (mm)
ESPD2+3-40-2P	2P	275 V AC	20 kA	40 kA	10 kV	≤ 1,3 kV	TN	18
ESPD2+3-40-4P	4P	275 V AC	20 kA	40 kA	10 kV	≤ 1,3 kV	TN-S	36
ESPD2+3-40-1+1P	1+1P	275 V AC	20 kA	40 kA	10 kV	≤ 1,3 kV / 1,5 kV	TN, TT	18
ESPD2+3-40-3+1P	3+1P	275 V AC	20 kA	40 kA	10 kV	≤ 1,3 kV / 1,5 kV	TN-S, TT	36

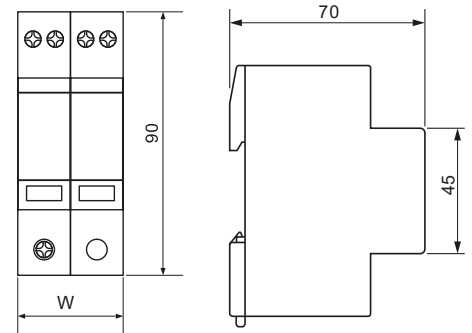

1+2+3. típusú túlfeszültség-levezetők

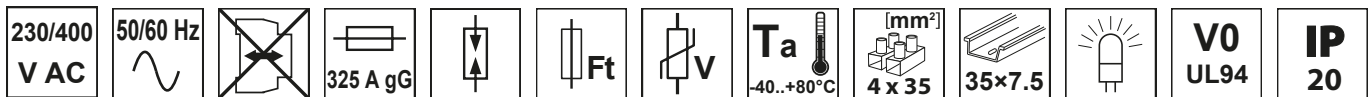

TRACON	xP	U _c	I _{imp} L-N/(N-PE)1P 10/350μs	I _n L-N/(N-PE) 8/20μs	I _{max} 8/20μs	U _{oc}	U _p L-N/(N-PE)		W (mm)
ESPD1+2+3-25-1P	1P	275 V AC	25 kA	25 kA	100 kA	20 kV	≤ 1,3 kV	TN	36
ESPD1+2+3-25-2P	2P	275 V AC	25 kA	25 kA	100 kA	20 kV	≤ 1,3 kV	TN	72
ESPD1+2+3-25-3P	3P	275 V AC	25 kA	25 kA	100 kA	20 kV	≤ 1,3 kV	TN-C	108
ESPD1+2+3-25-4P	4P	275 V AC	25 kA	25 kA	100 kA	20 kV	≤ 1,3 kV	TN-S	144
ESPD1+2+3-25-1+1P	1+1P	275 V AC	25 kA / 100 kA	25 kA / 100 kA	100 kA	20 kV	≤ 1,3 kV / 1,5 kV	TN, TT	72
ESPD1+2+3-25-3+1P	3+1P	275 V AC	25 kA / 100 kA	25 kA / 100 kA	100 kA	20 kV	≤ 1,3 kV / 1,5 kV	TN-S, TT	144

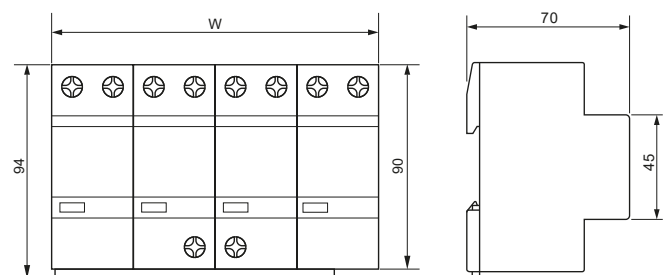

3. típusú túlfeszültség-levezetők

Piktogramok

TRACON	xP	U _n	U _c	I _n L-N/(N-PE) 8/20µs	I _{max} 8/20µs	U _{oc}	U _p	gG	W (mm)	
ESPD3-3-2P	1+1P	230 V AC	275 V AC	3 kA	6 kA	6 kV	≤ 1,2 kV	16 A	TN, TT	36×24×15
ESPD3-5-1+1P	1+1P	230 V AC	275 V AC	5 kA	10 kA	10 kV	≤ 1,1 kV	32 A	TN, TT	18
ESPD3-5-2P	2P	230 V AC	275 V AC	5 kA	10 kA	10 kV	≤ 1,1 kV	32 A	TN	18
ESPD3-10-1+1P	1+1P	230 V AC	275 V AC	10 kA	20 kA	20 kV	≤ 1,2 kV	63 A	TN, TT	18
ESPD3-10-2P	2P	230 V AC	275 V AC	10 kA	20 kA	20 kV	≤ 1,2 kV	63 A	TN	18

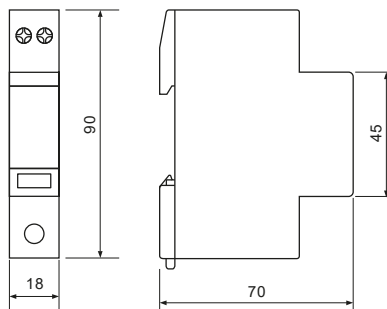
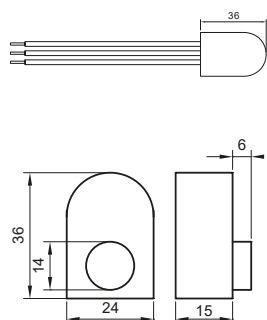

1+2. és 2. típusú DC túlfeszültség-levezetők



TRACON	xP	U _n	U _c	gG	I _{imp} L-N/(N-PE)1P 10/350µs	I _n L-N/(N-PE) 8/20µs	I _{max} 8/20µs	U _p	W (mm)
ESPD1+2-DC50-600	3P	600 V DC	800 V DC	200 A	12,5 kA	20 kA	50 kA	≤ 3 kV	72
ESPD1+2-DC50-1000	3P	1.000 V DC	1.200 V DC					≤ 4 kV	72
ESPD2-DC40-600	3P	600 V DC	800 V DC	125 A	—	20 kA	40 kA	≤ 3 kV	72
ESPD2-DC40-1000	3P	1.000 V DC	1.200 V DC					≤ 4 kV	72
ESPD2-DC40-600V*		600 V DC	800 V DC	125 A	—	20 kA	40 kA	≤ 3 kV	18
ESPD2-DC40-600VG*		600 V DC	800 V DC					≤ 3 kV	18
ESPD2-DC40-1000V*		1.000 V DC	1.200 V DC					≤ 4 kV	18
ESPD2-DC40-1000VG*		1.000 V DC	1.200 V DC					≤ 4 kV	18

* cserélhető betétek

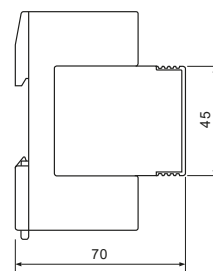
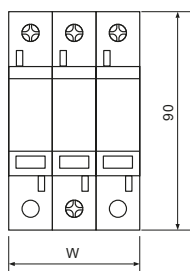
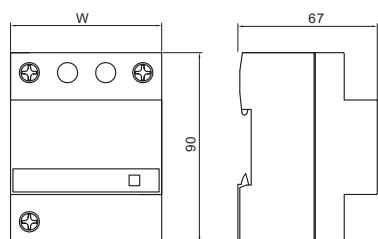

Kombinált (1+2 típusú) tűlfeszültség-levezetők

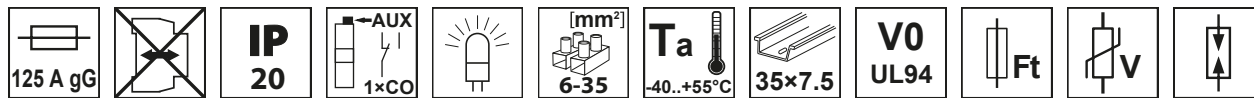

TRACON	xP	I_{imp} 1P 10/350µs	I_{max} 8/20µs	U_n	U_p	U_c	W (mm)	
TTV1+2-100-1P	1P	8 kA	100 kA	230/400 V, 50 Hz	2,2 kV	385 V AC, 500 V DC	27	TN, TT, IT
TTV1+2-100-2P	2P	8 kA	100 kA				54	TN, TT, IT
TTV1+2-100-3P	3P	8 kA	100 kA				81	TN, TT, IT
TTV1+2-100-4P	4P	8 kA	100 kA				108	TN, TT, IT
TTV1+2-100-3P+N/PE	3P+N/PE	8 kA	100 kA		108	TN, TT, IT		
TTV1+2-80-1P	1P	8 kA	80 kA		2,2 kV	385 V AC, 500 V DC	27	TN, TT, IT
TTV1+2-80-2P	2P	8 kA	80 kA				54	TN, TT, IT
TTV1+2-80-3P	3P	8 kA	80 kA				81	TN, TT, IT
TTV1+2-80-4P	4P	8 kA	80 kA				108	TN, TT, IT
TTV1+2-80-3P+N/PE	3P+N/PE	8 kA	80 kA				108	TN, TT, IT

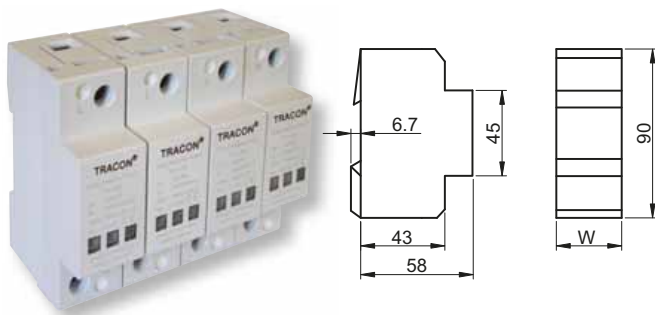

Ezek a készülékek háromfázisú ill. egyfázisú (szabadvezetékű) betápláló hálózatokban a villámcsapások során esetlegesen kialakuló 10/350 µs hullámalakú, nagy energiájú lököáramok és/vagy a kapcsolási eredetű (8/20 µs hullámalakú) túlárak keltette tűlfeszültségek levezetésére alkalmasak.

Kompakt (egybeépített) kivitelek. Az 1+2 típusú védelmi egységeket tartalmazó levezetőket az első zárlatvédő berendezés és közvetlenül a fogyasztásmérő után (a főelosztóba) kell beépíteni.

Figyelem! Általában a kombinált készülékek levezetési képessége nem éri el az önálló fokozatok szintjét!

A készülékek megfelelő méretezés mellett fotovoltaikus (DC) rendszerben is alkalmazhatók!

A kiválasztási segédletet lásd az F/2-3 oldalon!

2-es típusú DC tűlfeszültség-levezetők

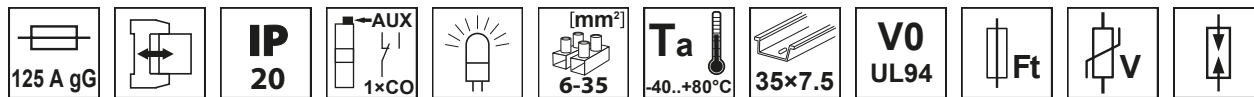

TRACON	xP	U_n	U_p	U_c	I_n L-N 8/20µs	I_{max} 8/20µs
TTV2-40-DC-600	3P	600 V DC	3 kV	800 V DC	20 kA	40 kA
TTV2-40-DC-1000	3P	1000 V DC	4 kV	1200 V DC	20 kA	40 kA



Betétek

TRACON	I_n L-N 8/20µs	I_{max} 8/20µs	U_p
TTV2-40-DC-600-M	20 kA	40 kA	3 kV
TTV2-40-DC-1000-M	20 kA	40 kA	4 kV
TTV2-40-DC-600-V	20 kA	40 kA	3 kV
TTV2-40-DC-1000-V	20 kA	40 kA	4 kV
TTV2-40-DC-600-G	20 kA	40 kA	3 kV
TTV2-40-DC-1000-G	20 kA	40 kA	4 kV

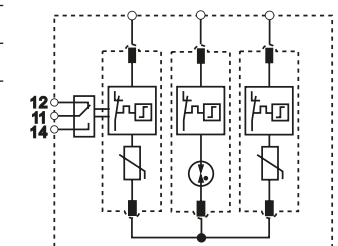
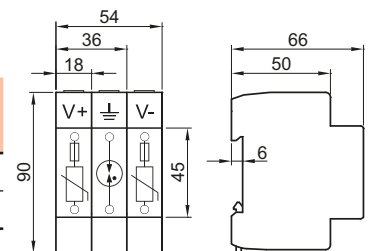

RELEVANT STANDARD
EN 61643

Ezek a készülékek a kapcsolási eredetű (8/20 µs hullámalakú) túlárak keltette tűlfeszültségek levezetésére alkalmasak.

Az 2-es típusú DC tűlfeszültség levezetőket kifejezetten a napelemes (PV) rendszerek egyenáramú áramkörében történő alkalmazásra tervezték. Cserélhető modulós kivitelek. A segédérintkező az aljzatba van beépítve.

2-es típusú túlfeszültség-levezetők

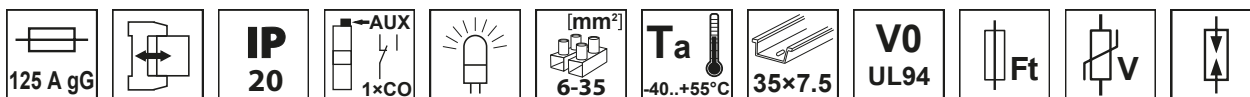

TRACON	xP	I_n L-N 8/20 μ s	I_{max} 8/20 μ s	U_n	U_p	U_c	W (mm)	
TTV2-60-1P	1P	30 kA	60 kA	230 V, 3x230/400 V	2,0 kV	385 V AC	18	TN, TT, IT
TTV2-60-2P	2P	30 kA	60 kA				36	TN, TT, IT
TTV2-60-3P	3P	30 kA	60 kA				54	TN, TT, IT
TTV2-60-3P+N/PE	3P+N/PE	30 kA	60 kA				72	TN, TT, IT
TTV2-60-4P	4P	30 kA	60 kA				72	TN, TT, IT
TTV2-40-1P	1P	20 kA	40 kA				1,8 kV	385 V AC
TTV2-40-2P	2P	20 kA	40 kA		36	TN, TT, IT		
TTV2-40-3P	3P	20 kA	40 kA		54	TN, TT, IT		
TTV2-40-3P+N/PE	3P+N/PE	20 kA	40 kA		72	TN, TT, IT		
TTV2-40-4P	4P	20 kA	40 kA		72	TN, TT, IT		
TTV2-30-1P+N/PE*	1P+N/PE	15 kA	30 kA		1,5 kV	320 V AC		
TTV2-30-3P+N/PE**	3P+N/PE	15 kA	30 kA				36	TN, TT, IT
TTV2-20-1P	1P	10 kA	20 kA	1,5 kV	385 V AC	18	TN, TT, IT	
TTV2-20-2P	2P	10 kA	20 kA			36	TN, TT, IT	
TTV2-20-3P	3P	10 kA	20 kA			54	TN, TT, IT	
TTV2-20-3P+N/PE	3P+N/PE	10 kA	20 kA			72	TN, TT, IT	
TTV2-20-4P	4P	10 kA	20 kA			72	TN, TT, IT	

* 2 db levezető egy modul szélességű készülékben az egyfázisú TNC-S és TNS típusú hálózatokhoz

** 4 db levezető kettő modul szélességű készülékben a háromfázisú TNC-S és TNS típusú hálózatokhoz

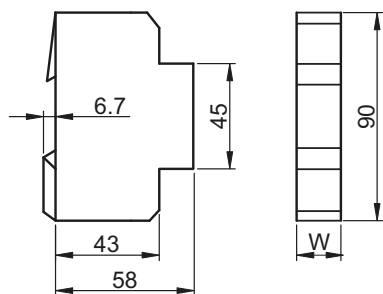

Ezek a készülékek a kapcsolási eredetű (8/20 μ s hullám alakú) túláramok keltette túlfeszültségek levezetésére alkalmasak.

Az 2-es típusú levezetőket az elosztóhálózat 1-es típusú levezetőket is tartalmazó főelosztói után, az alelosztókba (többlakásos épületekben a lakáselosztókba) kell beépíteni. A megfelelő működés érdekében az 1-es típusú és a 2-es típusú levezetők között legalább 10 – 15 méter hosszúságú vezeték szakaszt vagy csatolófójtót kell alkalmazni. Cserélhető modulos kivitelek. A segédérintkező az aljzatba van beépítve.

Betétek + aljzatok

TRACON	I_n L-N 8/20 μ s	I_{max} 8/20 μ s	W (mm)	TTV2-BASE-2P	TTV2-BASE-3P	TTV2-BASE-4P
TTV2-60-M	30 kA	60 kA	18	OK	OK	OK
TTV2-40-M	20 kA	40 kA	18	-	-	-
TTV2-30-A-M*	15 kA	30 kA	18	-	-	-
TTV2-30-B-M**	15 kA	30 kA	18	-	-	-
TTV2-20-M	10 kA	20 kA	18	-	-	-
TTV2-40-N/PE-M	20 kA	40 kA	18	OK	OK	OK

*2P betét TTV2-30-3P+N/PE készülékhez

**1P+N/PE betét TTV2-30-1P+N/PE és TTV2-30-3P+N/PE készülékhez



TTV2-20-M

TTV2-40-N/PE-M

3-as típusú túlfeszültség-levezetők (finomvédelem), sorolható kivitel

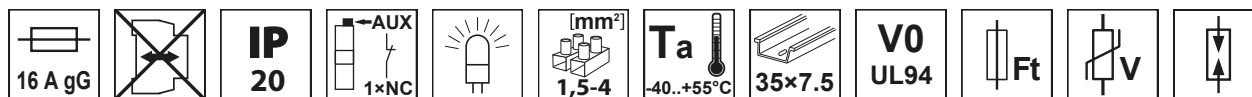

TRACON	xP	I _n L-N 8/20µs	I _{max} 8/20µs	U _n	U _p	U _c	W (mm)	
TTV3-10-1P+N/PE	1P+N/PE	5 kA	10 kA	230 V, 50 Hz; 1~	1,5 kV	385/440 V	36	TN, TT
TTV3-10-3P+N/PE	3P+N/PE	5 kA	10 kA	3×230/400 V, 50 Hz; 3~			72	TN, IT



RELEVANT STANDARD
EN 61643

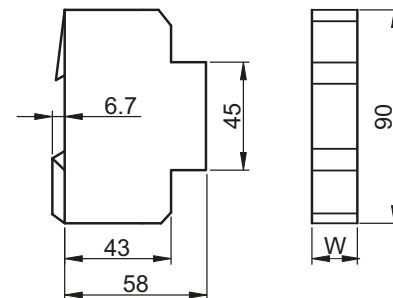

Az 3-as típusú levezetőket a lehető legközelebb célszerű elhelyezni a védendő készülékhez.

Másodlagos villámvédelmi egységek, amelyek a hálózaton végrehajtott kapcsolásokból adódó feszültségcsúcsokat is korlátozzák és megakadályozzák, hogy a túlfeszültség zavarok az áramellátó vezetéseken keresztül az elektronikus berendezésekbe juthassanak és azokban meghibásodásokat okozzanak. Kompakt (egybeépített) kivitelek.

Figyelem! Egyedüli védőkészülékként, önállóan azonban nem képesek a berendezések túlfeszültsége elleni védelmét megoldani!

Az egy és háromfázisú, elosztódobozba szerelhető kivitelek a védendő készülékkel párhuzamosan vagy sorosan csatlakoztathatóak. Soros csatlakozás esetén a védőkészüléket a túláramvédelem után kell beépíteni.

MINŐSÉG ÉS BIZTONSÁG

3-as típusú túlfeszültség-levezetők (finomvédelem), beépíthető kivitel

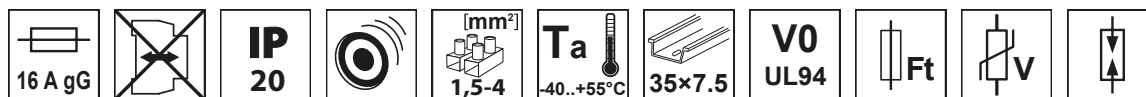

TRACON	$\times P$ 1P+N-PE	I_n L-N 8/20 μ s	I_{max} 8/20 μ s	U_n	U_p	U_c	
TTV3-5-1P+N-PE	1P+N-PE	2,5 kA	5 kA	230 V, 50 Hz; 1~	1,25 kV	255 V AC	TN, IT

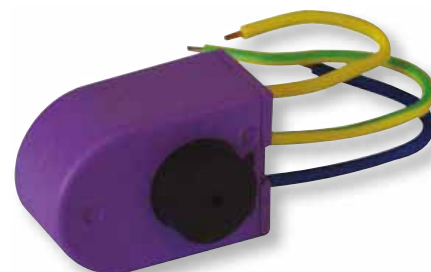
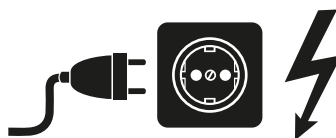
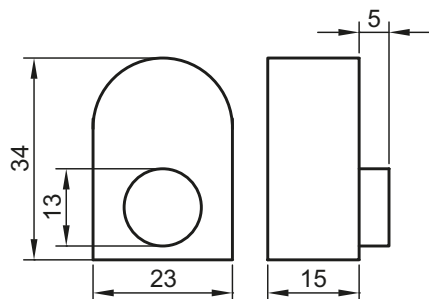

Az 3-as típusú levezetőket a lehető legközelebb célszerű elhelyezni a védendő készülékhez.

Másodlagos villámvédelmi egységek, amelyek a hálózaton végrehajtott kapcsolásokból adódó feszültségcsúcsokat is korlátozzák és megakadályozzák, hogy a túlfeszültség zavarok az áramellátó vezetéseken keresztül az elektronikus berendezésekbe juthassanak és azokban meghibásodásokat okozzanak. Kompakt (egybeépített) kivitelek.

Győzelem! Egyedüli védőkészülékként, önállóan azonban nem képesek a berendezések túlfeszültség elleni védelmét megoldani!

2+3 típusú túlfeszültség-levezető (LED meghajtóhoz)

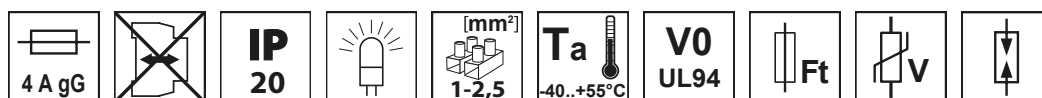

TRACON	I_n L-N 8/20 μ s	I_{max} 8/20 μ s	U_n	U_p	U_c	
TTVL2+3-10	5 kA	10 kA	230 V, 50 Hz	1,5 kV	320 V AC	TN, IT

A TTVL2+3-10 kompakt túlfeszültség-levezető LED meghajtók védelmére szolgál. A 2+3 típusú LED túlfeszültség-levezető az egyfázisú 120-277 VAC feszültségű meghajtót védi a villám és kapcsolási tranziensek következtében fellépő túlfeszültségek ellen.

Meghibásodását a készüléken kigyulladó jelzőfény jelzi.

A világítótest villámcsapás következtében fellépő túlfeszültség elleni védelemre szolgáló eszköz: LSJA, LSJB (E/16-17)

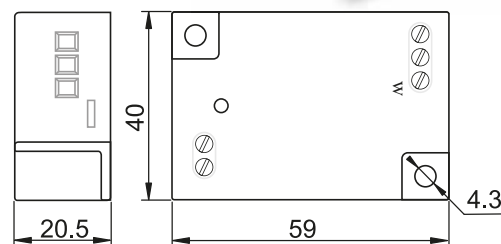

Csatoló fojtó

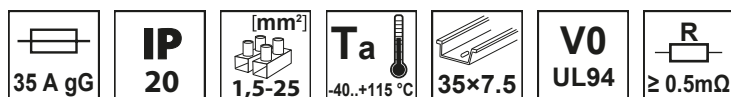

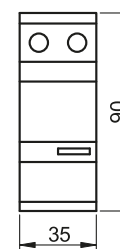
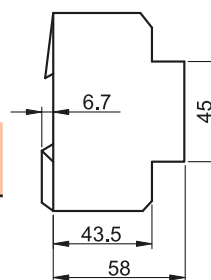

TRACON	$\times 17,5$ 2	I_n	U_n	L
TTV-CSF35	2	35 A	500 V AC/DC	18 μ H \pm 10 %

Az 1-es típusú villámáram-levezető és a komplex túlfeszültségvédelmi rendszerben utána következő 2-es típusú túlfeszültség-levezető készülékek koordinált működési sorrendjének alapvető feltétele, hogy a fokozatok közötti feszültségkülönbség kialakulásához megfelelő nagyságú impedancia legyen közéjük beépítve. Ez a feltétel általában teljesül, ha a két védőkészülék között legalább 10 – 15 méter hosszúságú vezetékszakas van.



Kismegszakítók

TRACON			I_n	I_{cn} EN60698	
EVON	C	1+N	6 – 32 A	4,5 kA	F/19
EVOZ	B, C	1, 2, 3, 4	1 – 63 A	6 kA	F/16
EVOTDA	B, C	1, 2, 3, 4	1 – 63 A	10 kA	F/17
EVOH	C	1, 2, 3, 4	63 – 125 A	10 kA	F/18
DPN	C	1+N	6 – 32 A	4,5 kA	F/30
MB	B, C	1, 2, 3	6 – 63 A	4,5 kA	F/31
TDZ	B, C, D	1, 2, 3, 4	1 – 63 A	6 kA	F/32
DC	C	1, 2, 3, 4	6 – 63 A	6/10 kA	F/33
KMH	C	1, 2, 3, 4	63 – 125 A	6 kA	F/34

A kismegszakítók villamos hálózatok túlterhelés elleni védelmére, valamint az elektromos zárlatból adódó meghibásodások megelőzésére, illetve környezet- és balesetvédelem megvalósítására szolgálnak. A kioldás történhet ikerfémes hőkioldóval (túlterhelés esetén), vagy elektromágneses gyorskioldóval (zárlat esetén), ill. kézi működtetéssel. A többpólusú kivitelek pólusainak kapcsolása egyszerre, egy időben történik.

Kioldási jelleggörbék

Az EN 60898 szabvány meghatározza a működési jellemzőket, a kialakítás és a szerkezeti felépítés követelményeit, valamint a vizsgálatok rendjét. Mindhárom jelleggörbe (B, C, D) kismegszakítói a túlterhelési tartományban ($<2,55 \times I_n$) azonos működésűek. A különbség a $3 \times I_n$ -nél nagyobb túlterhelési tartományban mutatkozik, ahol a B típusú, $3 \dots 5 \times I_n$, a C típusú $5 \dots 10 \times I_n$, a D típusú kismegszakítók $10 \dots 15 \times I_n$ nagyságú áram fellépésekor oldanak ki.

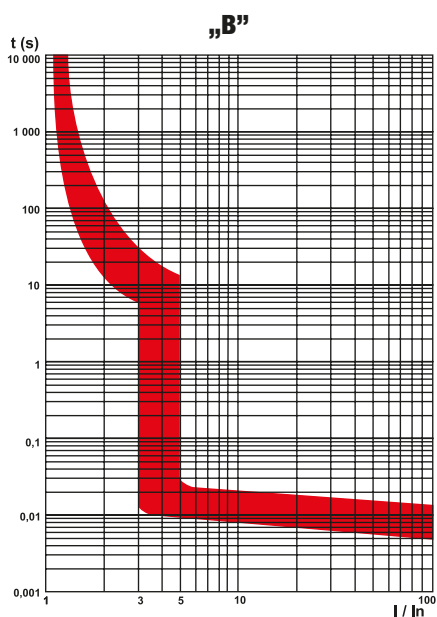

Általános felhasználásra - kis indítóáramú fogyasztók, izzólámpás áramkörök, vezeték védelmére.

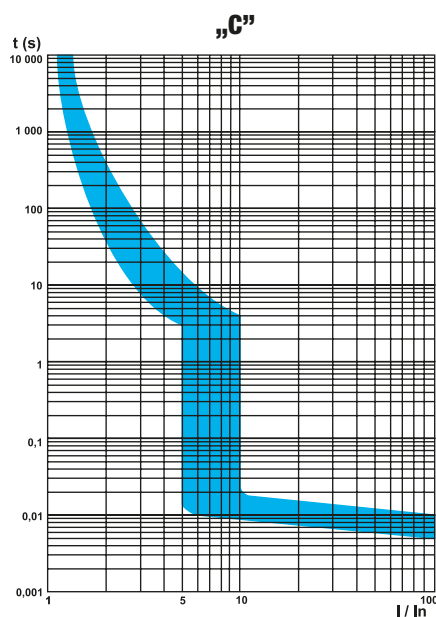

Általános felhasználásra – háztartási villamos gépek, készülékek, kis áramlökésű motorok védelmére.

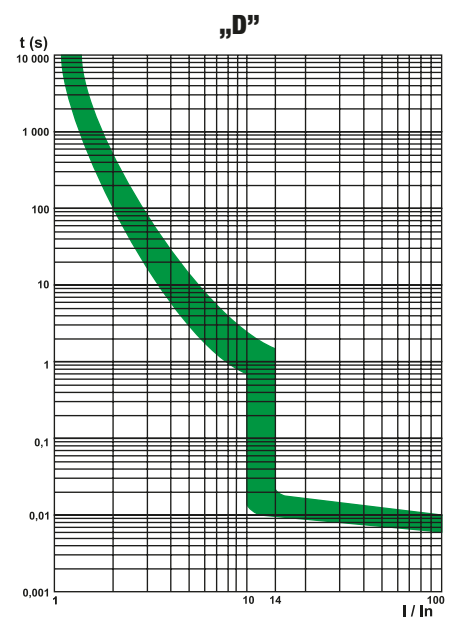

Nagy indítóáramú motorok, transzformátorok, egyéb induktív jellegű fogyasztók védelmére.

Hőmérséklet függőségi adatok

A kismegszakítókra megengedett maximális terhelési áram a környezeti hőmérséklet emelkedésével csökken. Ha pl. több kismegszakító közvetlenül egymás mellé kerül beszerelésre egy elosztószekrénybe, akkor a szekrényen belül várható hőmérsékletemelkedést a kismegszakítók megválasztásakor figyelembe kell venni.





Pl.: Míg egy 16 A-es névleges áramú ($I_n = 16$ A) kismegszakító maximális terhelési árama 17,9 A lehet 20 °C-on, addig ez az érték 40 °C éppen a névleges 16 A-es árammal egyenlő, azonban 60 °C-on már csak 13,9 A lehet.

A kismegszakítók működési **referencia hőmérséklete 40 °C**.

Maximálisan megengedett terhelési áram (A)

I_n (A)	20 °C	30 °C	40 °C	50 °C	60 °C
2	2.18	2.08	2	1.9	1.8
4	4.52	4.24	4	3.72	3.44
6	6.48	6.24	6	5.76	5.46
10	11.4	10.7	10	9.2	8.4
16	17.9	16.9	16	15	13.9
20	22.2	21.2	20	18.8	17.6
25	27.7	26.5	25	23.5	21.7
32	35.2	33.6	32	30.4	28.4
40	44.4	42.4	40	37.5	34.8
50	56	53	50	46.5	43
63	71.8	67.4	63	57.9	52.9



Kombinált védőkapcsolók

TRACON		xP 	x17.5 	I_n (A)	I_{cn} EN60698	
EVOKE	B, C	2	1	6 – 32 A	6 kA	F/19
EVOK	B, C	2	2	6 – 40 A	4.5 kA	F/20
EVOKM	B, C	2	2	6 – 63 A	6 kA	F/20
KVKVE	B, C	2	1	6 – 32 A	6 kA	F/35
KVK	B, C	2	2	6 – 32 A	3 kA	F/35
KVKM	B, C	2	2	6 – 40 A	6 kA	F/36

A kombinált védőkapcsoló elsősorban az épületvillanszerelés (installáció) területén történő felhasználásra szánt olyan készülék, amely egyaránt alkalmas személyek áramütés elleni védelmére, túlterhelés elleni védelemre és zárlatvédelemre. Különösen alkalmas olyan helyiségek áramkörében történő alkalmazásra, amelyekben fokozott biztonságot kívánunk létrehozni (pl. gyermekszoba, kórterem, stb.). Mechanikai méreteinél fogva, az igények utólagos változása esetén a meglévő védőkészülék (kismegszakító) helyére egyszerűen beépíthető. A három funkció ellátására a közös házban elhelyezett áram-védőkapcsoló összegző áramváltója; az ütközőhorgonyos mágneses gyorskioldó és a bimetallos termikus túláramvédelmi kioldó szolgál. A védendő fogyasztó áramkörét mindkét pólusban megszakítja. A termék áram-védőkapcsoló részének működőképességét a „T” jelű próbagomb megnyomásával lehet ellenőrizni. Az ellenőrzést lehetőleg havonta végre kell hajtani. A megfelelő működés biztosítása érdekében a bekötéskor be kell tartani a kapcsolónál felüntetett jelöléseket!



Áram-védőkapcsolók

TRACON		I_n (A)	$I_{\Delta n}$ (mA)	I_{cn} EN60698	
EVOV	2, 4	25, 40, 63, 80	30, 100, 300	6 kA	F/21
RB	2, 4	25, 40, 63	30, 100, 300, 500	4,5 kA	F/36
TFV	2, 4	16, 25, 40, 63	30, 100, 300	6 kA	F/37
TFVH	4	80, 100	30, 100, 300	6 kA	F/37
EVOG	2, 4	25, 40, 63, 80	30, 100, 300	6 kA	F/22
TFG	2, 4	16, 25, 40, 63	30, 100, 300	6 kA	F/38
TFGA	–	16	30	6 kA	F/38
TFIG	2, 4	16, 25, 40, 63, 80	30, 100, 300	10 kA	F/39

TRACON	Megnevezés	EVOV	EVOG	RB	TFV	TFVH	TFG	TFIG
EDS-□, EDFK-□	elosztódobozok	✓	✓	✓	✓	✓	✓	✓
TFSS-□	normál sorolósínek	✓	✓	✓	✓	✓	✓	✓
TFSS-□V	villás sorolósínek	✓	✓	✓	✓	✓	✓	✓
TFSS-1CS	csavaros csatlakozókapocs	✓	✓	✓	✓	✓	✓	–
35/7,5□SIN	EN 50022 szerinti szerelősínek	✓	✓	✓	✓	✓	✓	✓

Az áram-védőkapcsoló a védővezetős rendszerű hálózatokban, a közvetett érintés elleni védelem legkorszerűbb eszköze, sőt néhány esetben a közvetlen érintés ellen is védelmet nyújt. A védőkapcsoló automatikusan működésbe lép, ha a védendő hálózatban a kialakuló hibaáram (pl. szigetelési hiba, testzárlat stb. esetén) nagysága eléri a kritikus értéket. 6000 A független zárlati áramnál nagyobb értékek esetén előtétbiztosítót kell alkalmazni. Felszerelése ajánlott, néhány esetben kötelező, mint pl. szabad-téri csatlakozók előtt, építkezési felvonulási szekrényekben, betonkeverők, pezsgőfürdős fürdőszobák stb. esetében.



EVO MODULÁRIS TERMÉKCSALÁD



**Kismegszakítók,
6 kA-10 kA**



F/16

**Kismegszakítók,
1+N**



F/19

**Kombinált
védőkapcsolók**



F/19

**Áram-védő-
kapcsolók**



F/21

**Leválasztó
kapcsolók**



F/23

Váltókapcsolók



F/24

**Lakatható szaka-
szoló kapcsolók**



F/25

Jelzőlámpák



F/25

**Moduláris
nyomógombok**



F/26

**Biztonsági (csengő)
transzformátorok**



F/26

**Installációs
kontaktorok**



F/27







**Automata vissza-
kapcsoló relék**



F/28

Keresse újdonságainkat webáruházunkban!

Segéd és hibajelző érintkező





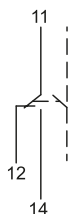
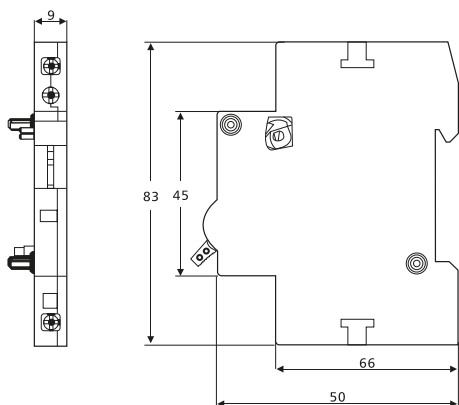

230/400 V AC  x5.000  x4.000 **IP 20**  35x7.5  [mm²] 0,5-4 **Ta**  -25..+55°C  U_i 500 V **V0** UL94

 **Piktogramok** **F/0**



TRACON		I _n (A) 400 V AC	I _n (A) 230 V AC	I _n (A) 110 V DC	I _n (A) 48 V DC	I _n (A) 24 V DC
EVOZ-AUX11	EVOZ					
EVOH-AUX11	EVOH					
EVOTDA-AUX11	EVOTDA					
EVOZ-AL	EVOZ	3 A	6 A	1 A	2 A	4 A
EVOH-AL	EVOH					
EVOTDA-AL	EVOTDA					



Munkaáramú (sönt) kioldó, feszültségcsökkenési és -növekedési kioldó

230/400 V AC  x4.000  x3.000 **IP 20**  35x7.5  [mm²] 0,5-4 **Ta**  -25..+55°C  U_i 500 V **V0** UL94



TRACON		U _m	 U _{up}	 U _{down}
EVOZ-SR*	EVOZ	110-415 V AC / 110-220 V DC	–	–
EVOH-SR*	EVOH	110-415 V AC / 110-220 V DC	–	–
EVOTDA-SR*	EVOTDA	110-415 V AC / 110-220 V DC	–	–
EVOZ-UOVR	EVOZ	–	280 V ± 5%	170 V ± 5%
EVOH-UOVR	EVOH	–	280 V ± 5%	170 V ± 5%
EVOTDA-UOVR	EVOTDA	–	280 V ± 5%	170 V ± 5%

*munkaáramú kioldó

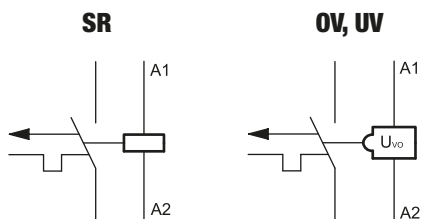
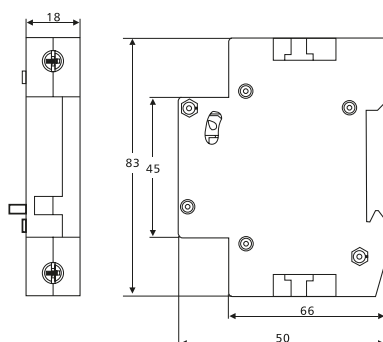

EVOZ kismegszakítók

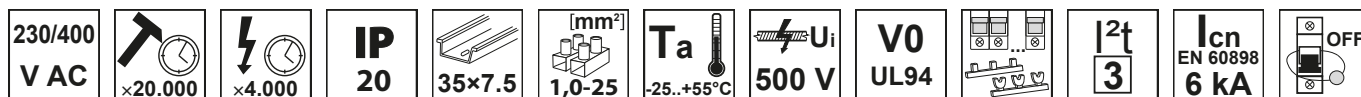

TRACON		I _n (A)
B	C	
EVOZ1B1	EVOZ1C1	1
EVOZ1B2	EVOZ1C2	2
EVOZ1B4	EVOZ1C4	4
EVOZ1B6	EVOZ1C6	6
EVOZ1B10	EVOZ1C10	10
EVOZ1B13	EVOZ1C13	13
EVOZ1B16	EVOZ1C16	16
EVOZ1B20	EVOZ1C20	20
EVOZ1B25	EVOZ1C25	25
EVOZ1B32	EVOZ1C32	32
EVOZ1B40	EVOZ1C40	40
EVOZ1B50	EVOZ1C50	50
EVOZ1B63	EVOZ1C63	63
EVOZ2B1	EVOZ2C1	1
EVOZ2B2	EVOZ2C2	2
EVOZ2B4	EVOZ2C4	4
EVOZ2B6	EVOZ2C6	6
EVOZ2B10	EVOZ2C10	10
EVOZ2B13	EVOZ2C13	13
EVOZ2B16	EVOZ2C16	16
EVOZ2B20	EVOZ2C20	20
EVOZ2B25	EVOZ2C25	25
EVOZ2B32	EVOZ2C32	32
EVOZ2B40	EVOZ2C40	40
EVOZ2B50	EVOZ2C50	50
EVOZ2B63	EVOZ2C63	63

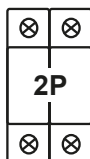

TRACON		I _n (A)
B	C	
EVOZ3B1	EVOZ3C1	1
EVOZ3B2	EVOZ3C2	2
EVOZ3B4	EVOZ3C4	4
EVOZ3B6	EVOZ3C6	6
EVOZ3B10	EVOZ3C10	10
EVOZ3B13	EVOZ3C13	13
EVOZ3B16	EVOZ3C16	16
EVOZ3B20	EVOZ3C20	20
EVOZ3B25	EVOZ3C25	25
EVOZ3B32	EVOZ3C32	32
EVOZ3B40	EVOZ3C40	40
EVOZ3B50	EVOZ3C50	50
EVOZ3B63	EVOZ3C63	63
EVOZ4B1	EVOZ4C1	1
EVOZ4B2	EVOZ4C2	2
EVOZ4B4	EVOZ4C4	4
EVOZ4B6	EVOZ4C6	6
EVOZ4B10	EVOZ4C10	10
EVOZ4B13	EVOZ4C13	13
EVOZ4B16	EVOZ4C16	16
EVOZ4B20	EVOZ4C20	20
EVOZ4B25	EVOZ4C25	25
EVOZ4B32	EVOZ4C32	32
EVOZ4B40	EVOZ4C40	40
EVOZ4B50	EVOZ4C50	50
EVOZ4B63	EVOZ4C63	63

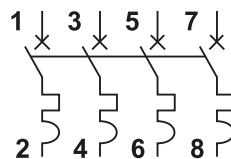
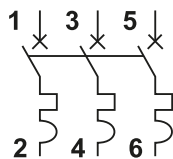
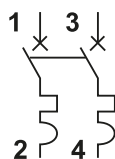
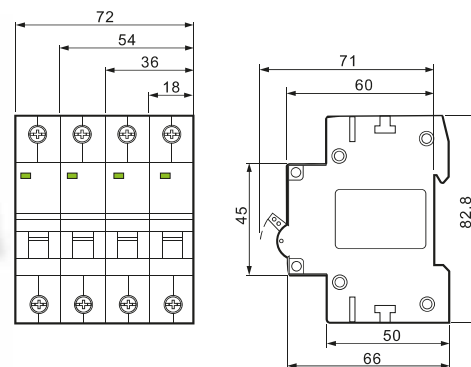
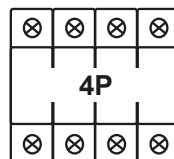
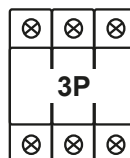

RELEVANT STANDARD
EN 60898-1

RELEVANT STANDARD
EN 60947-2



EVOTDA kismegszakító

TRACON		I _n (A)
B	C	
TDA-1B-1	TDA-1C-1	1
TDA-1B-2	TDA-1C-2	2
TDA-1B-4	TDA-1C-4	4
TDA-1B-6	TDA-1C-6	6
TDA-1B-10	TDA-1C-10	10
TDA-1B-13	TDA-1C-13	13
TDA-1B-16	TDA-1C-16	16
TDA-1B-20	TDA-1C-20	20
TDA-1B-25	TDA-1C-25	25
TDA-1B-32	TDA-1C-32	32
TDA-1B-40	TDA-1C-40	40
TDA-1B-50	TDA-1C-50	50
TDA-1B-63	TDA-1C-63	63
<hr/>		
TDA-2B-1	TDA-2C-1	1
TDA-2B-2	TDA-2C-2	2
TDA-2B-4	TDA-2C-4	4
TDA-2B-6	TDA-2C-6	6
TDA-2B-10	TDA-2C-10	10
TDA-2B-13	TDA-2C-13	13
TDA-2B-16	TDA-2C-16	16
TDA-2B-20	TDA-2C-20	20
TDA-2B-25	TDA-2C-25	25
TDA-2B-32	TDA-2C-32	32
TDA-2B-40	TDA-2C-40	40
TDA-2B-50	TDA-2C-50	50
TDA-2B-63	TDA-2C-63	63

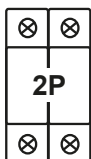
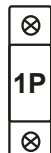

TRACON		I _n (A)
B	C	
TDA-3B-1	TDA-3C-1	1
TDA-3B-2	TDA-3C-2	2
TDA-3B-4	TDA-3C-4	4
TDA-3B-6	TDA-3C-6	6
TDA-3B-10	TDA-3C-10	10
TDA-3B-13	TDA-3C-13	13
TDA-3B-16	TDA-3C-16	16
TDA-3B-20	TDA-3C-20	20
TDA-3B-25	TDA-3C-25	25
TDA-3B-32	TDA-3C-32	32
TDA-3B-40	TDA-3C-40	40
TDA-3B-50	TDA-3C-50	50
TDA-3B-63	TDA-3C-63	63
<hr/>		
TDA-4B-1	TDA-4C-1	1
TDA-4B-2	TDA-4C-2	2
TDA-4B-4	TDA-4C-4	4
TDA-4B-6	TDA-4C-6	6
TDA-4B-10	TDA-4C-10	10
TDA-4B-13	TDA-4C-13	13
TDA-4B-16	TDA-4C-16	16
TDA-4B-20	TDA-4C-20	20
TDA-4B-25	TDA-4C-25	25
TDA-4B-32	TDA-4C-32	32
TDA-4B-40	TDA-4C-40	40
TDA-4B-50	TDA-4C-50	50
TDA-4B-63	TDA-4C-63	63

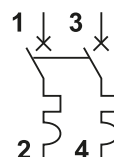
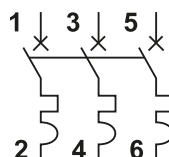
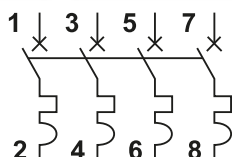
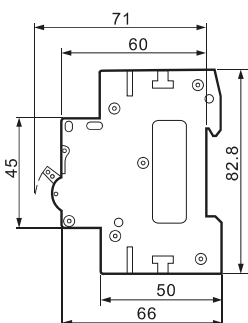
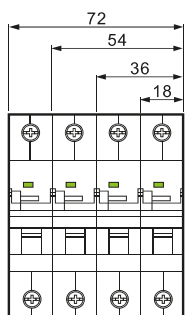
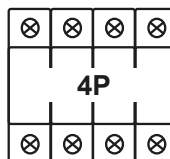
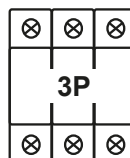

RELEVANT STANDARD
EN 60898

Piktogramok **F/0**



EVOH nagyáramú túláramvédelmi megszakítók

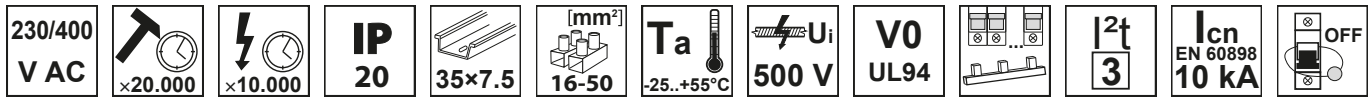

TRACON		I_n (A)
	EVOH163	63
	EVOH180	80
	EVOH1100	100
	EVOH1125	125

TRACON		I_n (A)
	EVOH363	63
	EVOH380	80
	EVOH3100	100
	EVOH3125	125

TRACON		I_n (A)
	EVOH263	63
	EVOH280	80
	EVOH2100	100
	EVOH2125	125

TRACON		I_n (A)
	EVOH463	63
	EVOH480	80
	EVOH4100	100
	EVOH4125	125

TRACON		I_n (A)
	EVOH263	63
	EVOH280	80
	EVOH2100	100
	EVOH2125	125

TRACON		I_n (A)
	EVOH463	63
	EVOH480	80
	EVOH4100	100
	EVOH4125	125

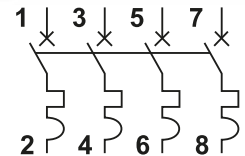
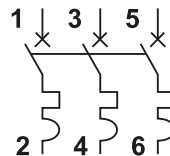

Kioldási jelleggörbe

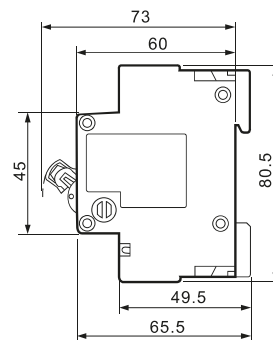
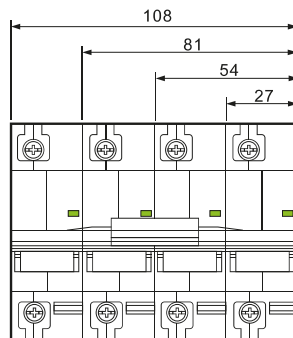
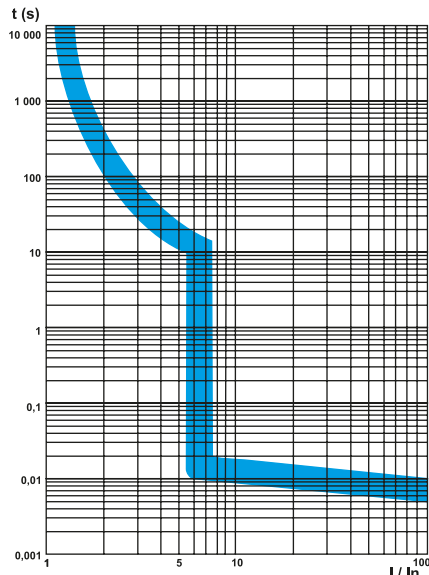

RELEVANT STANDARD
EN 60947-2



EVON (1+N pólusú) kismegszakító

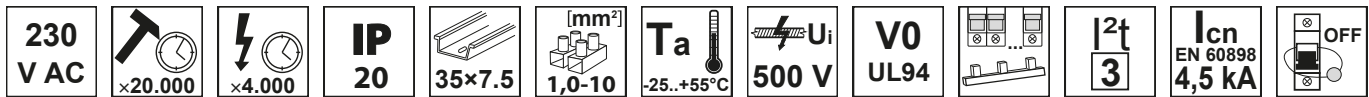

TRACON		I_n (A)

⊗	⊗
1P	N
⊗	⊗

EVONC6	6
EVONC10	10
EVONC16	16
EVONC20	20
EVONC25	25
EVONC32	32

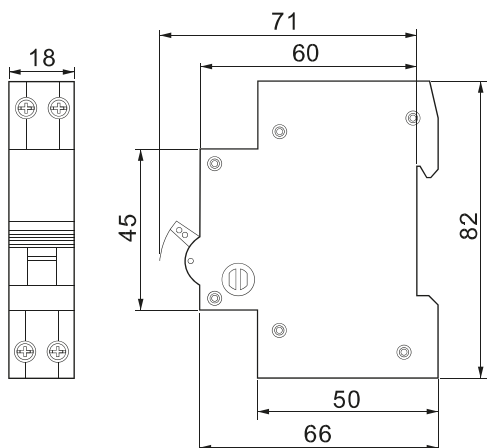
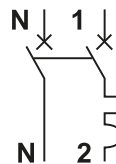

* Kétpólusú készülék, amely egy védett (fázis) és egy kapcsolt nulla (N) pólussal rendelkezik.

RELEVANT STANDARD
EN 60898-1



EVOKE kombinált védőkapcsoló 1 modul szélességben

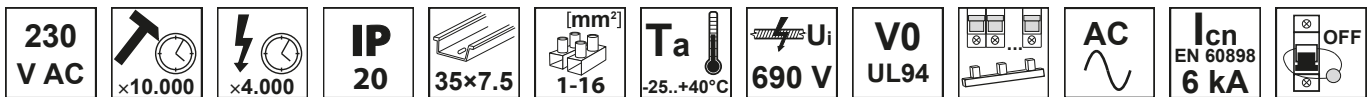

TRACON			
		I_n (A)	$I_{\Delta n}$ (mA)
EVOKEB603	EVOKEC603	6	30
EVOKEB1003	EVOKEC1003	10	30
EVOKEB1303	EVOKEC1303	13	30
EVOKEB1603	EVOKEC1603	16	30
EVOKEB2003	EVOKEC2003	20	30
EVOKEB2503	EVOKEC2503	25	30
EVOKEB3203	EVOKEC3203	32	30
EVOKEB4003	EVOKEC4003	40	30

⊗	⊗
2P	
⊗	⊗

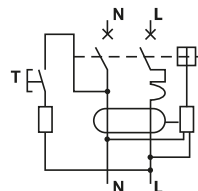

E3

Kioldási jelleggörbe

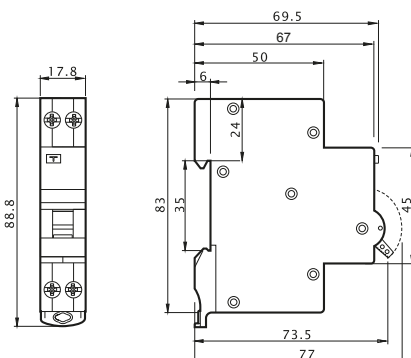
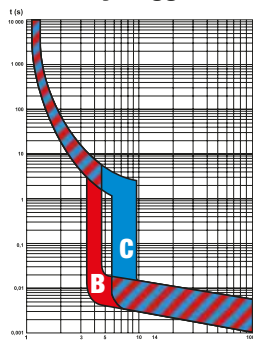

RELEVANT STANDARD
EN 61009-1

EVOK kombinált védőkapcsolók

230 V AC	$\times 10.000$	$\times 4.000$	IP 20	35x7.5	[mm ²] 1,5-25	Ta -25..+40°C	U _i 690 V	V0 UL94	AC	I _{cn} EN 60898 4,5 kA	OFF
----------	-----------------	----------------	-------	--------	------------------------------	------------------	-------------------------	------------	----	---------------------------------------	-----



Kioldási jelleggörbe

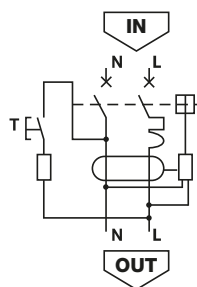
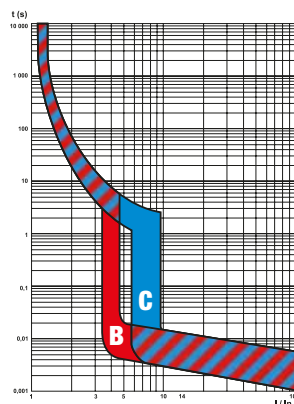

TRACON

			I _n (A)	I _{Δn} (mA)
	EVOK2B603	EVOK2C603	6	30
	EVOK2B1003	EVOK2C1003	10	30
	EVOK2B1603	EVOK2C1603	16	30
	EVOK2B2003	EVOK2C2003	20	30
	EVOK2B2503	EVOK2C2503	25	30
	EVOK2B3203	EVOK2C3203	32	30
	EVOK2B4003	EVOK2C4003	40	30

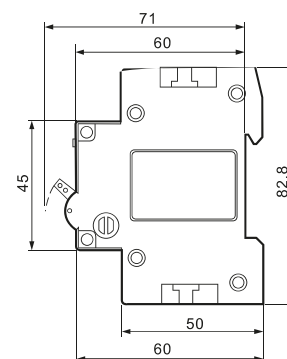
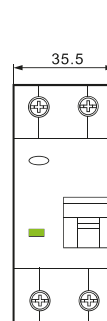
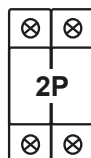

RELEVANT STANDARD
EN 61009-1

Piktogramok **F/0**

EVOKM kombinált védőkapcsolók, elektromechanikus

230 V AC	$\times 10.000$	$\times 4.000$	IP 20	35x7.5	[mm ²] 1,5-25	Ta -25..+55°C	U _i 690 V	V0 UL94	AC	I _{cn} EN 60898 6 kA	OFF
----------	-----------------	----------------	-------	--------	------------------------------	------------------	-------------------------	------------	----	-------------------------------------	-----



Kioldási jelleggörbe

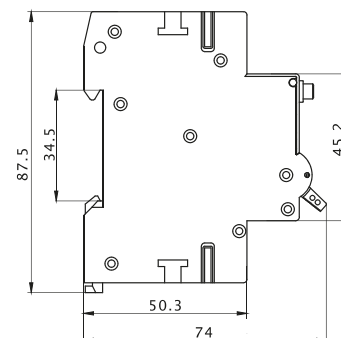
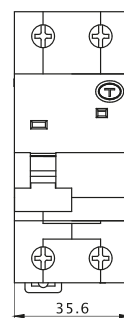
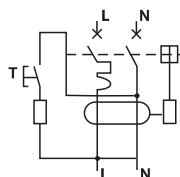
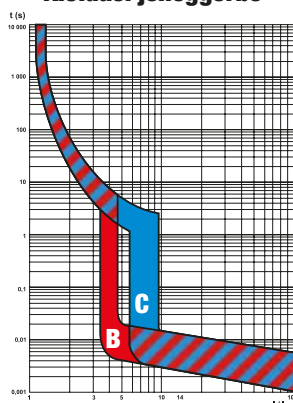

RELEVANT STANDARD
EN 61009-1

Az elektromechanikus kombinált védőkapcsoló nulla-vezeték szakadás esetén is védelmet nyújt az áramütés ellen!

EVOV áram-védőkapcsolók

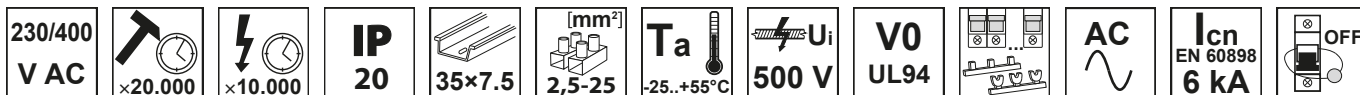

TRACON	I_n (A)	$I_{\Delta n}$ (mA)
EVOV2P2503	25	30
EVOV2P4003	40	30
EVOV2P6303	63	30
EVOV2P8003	80	30
EVOV2P251	25	100
EVOV2P401	40	100
EVOV2P631	63	100
EVOV2P801	80	100
EVOV2P253	25	300
EVOV2P403	40	300
EVOV2P633	63	300
EVOV2P803	80	300
EVOV4P2503	25	30
EVOV4P4003	40	30
EVOV4P6303	63	30
EVOV4P8003	80	30
EVOV4P251	25	100
EVOV4P401	40	100
EVOV4P631	63	100
EVOV4P801	80	100
EVOV4P253	25	300
EVOV4P403	40	300
EVOV4P633	63	300
EVOV4P803	80	300

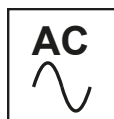
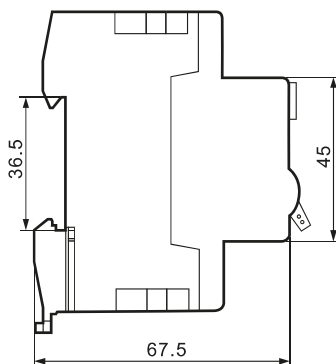
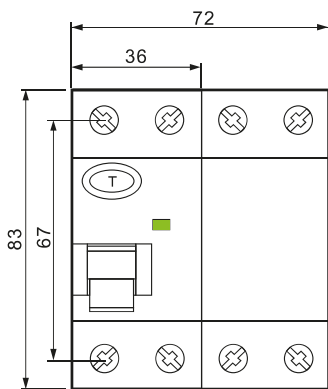
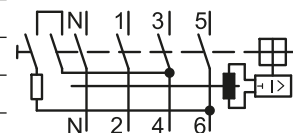
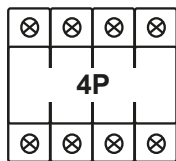
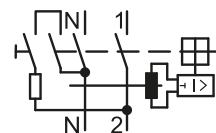
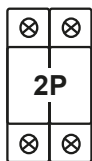

Váltakozó áramú hálózatokra!

RELEVANT STANDARD
EN 61008-1



EVOG áram-védőkapcsolók



TRACON	I_n (A)	$I_{\Delta n}$ (mA)
EVOG2P2503	25	30
EVOG2P4003	40	30
EVOG2P6303	63	30
EVOG2P8003	80	30
EVOG2P251	25	100
EVOG2P401	40	100
EVOG2P631	63	100
EVOG2P801	80	100
EVOG2P253	25	300
EVOG2P403	40	300
EVOG2P633	63	300
EVOG2P803	80	300
EVOG4P2503	25	30
EVOG4P4003	40	30
EVOG4P6303	63	30
EVOG4P8003	80	30
EVOG4P251	25	100
EVOG4P401	40	100
EVOG4P631	63	100
EVOG4P801	80	100
EVOG4P253	25	300
EVOG4P403	40	300
EVOG4P633	63	300
EVOG4P803	80	300

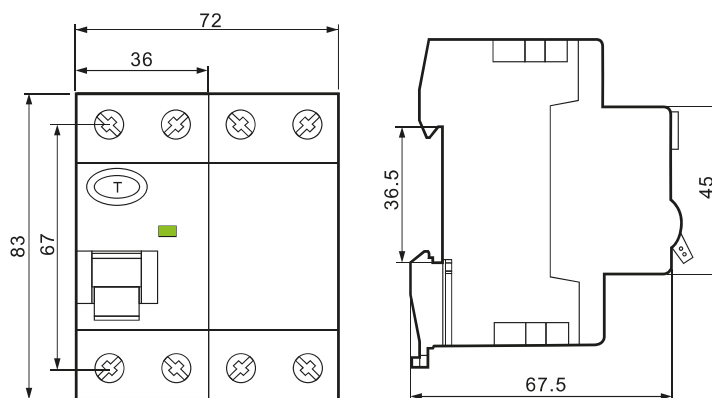
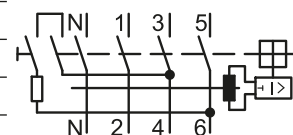
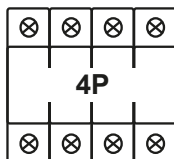
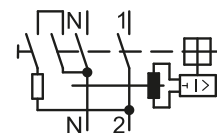
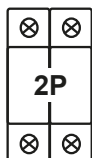

Váltakozó áramú és lüktető egyenáramú hálózatokra!





RELEVANT STANDARD
EN 61008-1

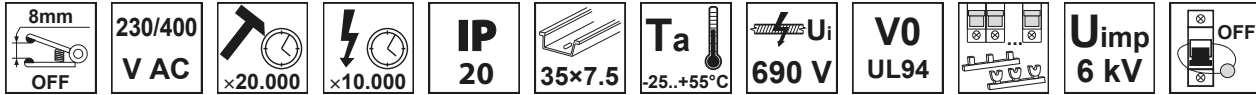

J/10-J/21

EVOTIK leválasztó kapcsolók

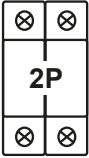

	TRACON	I _n (A)	mm ²
	TIK1-20	20	1,5-50
	TIK1-25	25	
	TIK1-32	32	
	TIK1-40	40	
	TIK1-63	63	
	TIK1-80	80	
	TIK1-100	100	
	TIK1-125	125	1,5-50
	TIK2-20	20	
	TIK2-25	25	
	TIK2-32	32	
	TIK2-40	40	
	TIK2-63	63	
	TIK2-80	80	
TIK2-100	100		
TIK2-125	125		

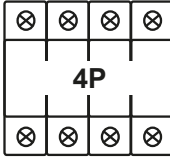
	TRACON	I _n (A)	mm ²
	TIK3-20	20	1,5-50
	TIK3-25	25	
	TIK3-32	32	
	TIK3-40	40	
	TIK3-63	63	
	TIK3-80	80	
	TIK3-100	100	
	TIK3-125	125	1,5-50
	TIK4-20	20	
	TIK4-25	25	
	TIK4-32	32	
	TIK4-40	40	
	TIK4-63	63	
	TIK4-80	80	
TIK4-100	100		
TIK4-125	125		

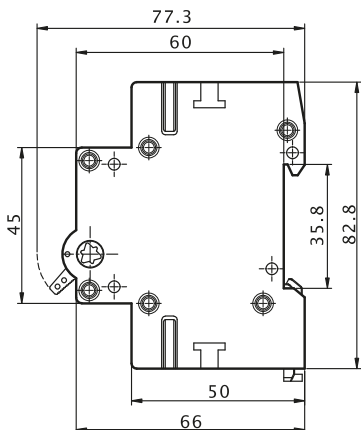
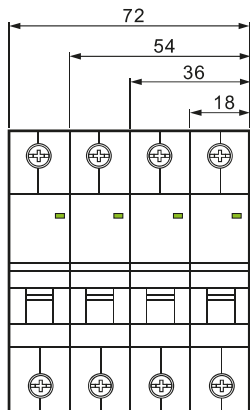
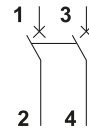
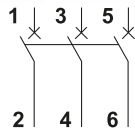
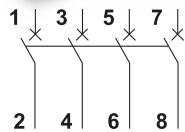
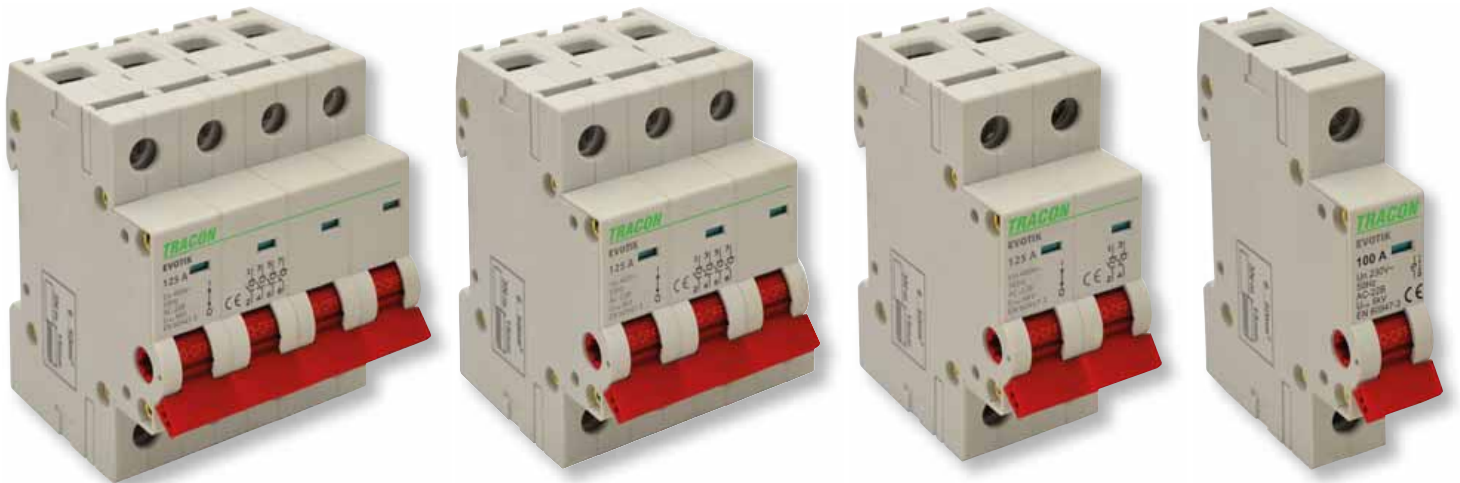

**RELEVANT STANDARD
EN 60947-3**



EVOSVK sorolható váltókapcsolók

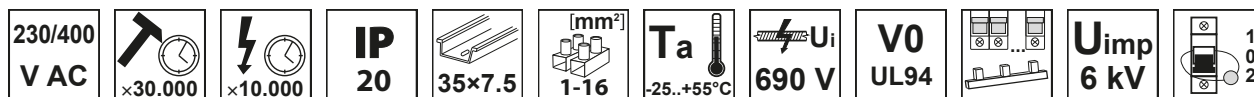

TRACON	I_n (A)
--------	-----------



SVK1-16	16
SVK1-32	32
SVK1-63	63

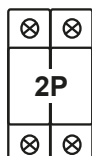

SVK2-16	16
SVK2-32	32
SVK2-63	63

TRACON	I_n (A)
--------	-----------

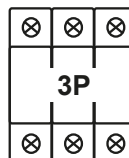

SVK3-16	16
SVK3-32	32
SVK3-63	63

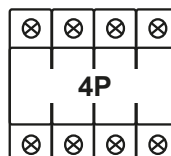

SVK4-16	16
SVK4-32	32
SVK4-63	63

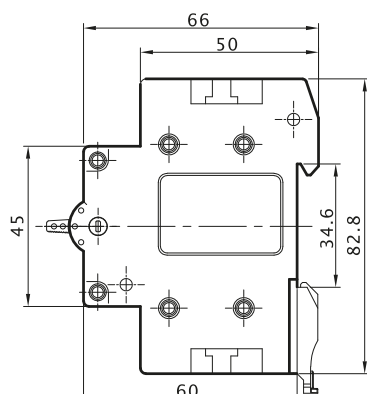
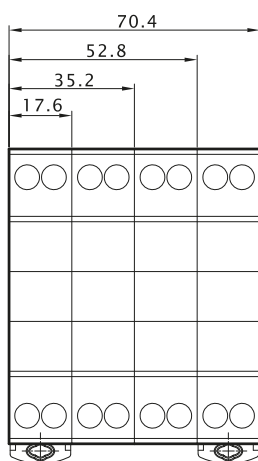
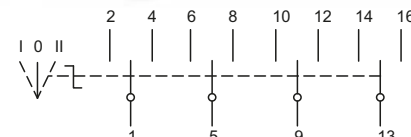
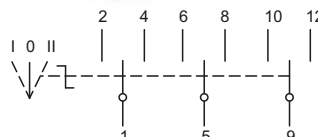
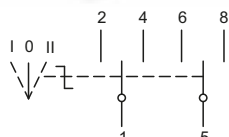
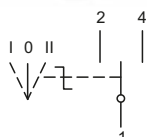

RELEVANT STANDARD
EN 60947-3

RELEVANT STANDARD
EN 60669-1



TÜV MEEI TEST DOCUMENTATION
28211822 001

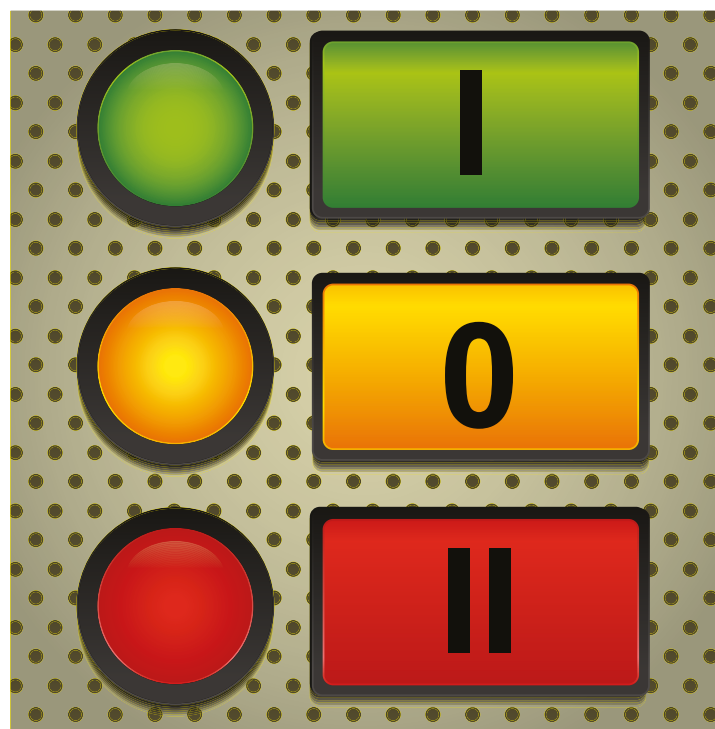

EVOMS sorolható, lakatolható szakaszoló kapcsoló

230/400 V AC
IP 20
35×7.5
Ta -25..+55°C
Ui 800 V
OFF

Piktogramok
F/0

TRACON	Ith (40 °C)	A (mm)	B (mm)	C (mm)	D (mm)	E (mm)	mm ²
EVOMS16/3	16A/3P						
EVOMS20/3	20A/3P	73,3	81	65,5	75,5	36,5	1,5-16
EVOMS25/3	25A/3P						
EVOMS40/3	40A/3P						
EVOMS80/3	80A/3P	88	97,5	76,5	93,5	52	25-50
EVOMS100/3	100A/3P						
EVOMS125/3	125A/3P						

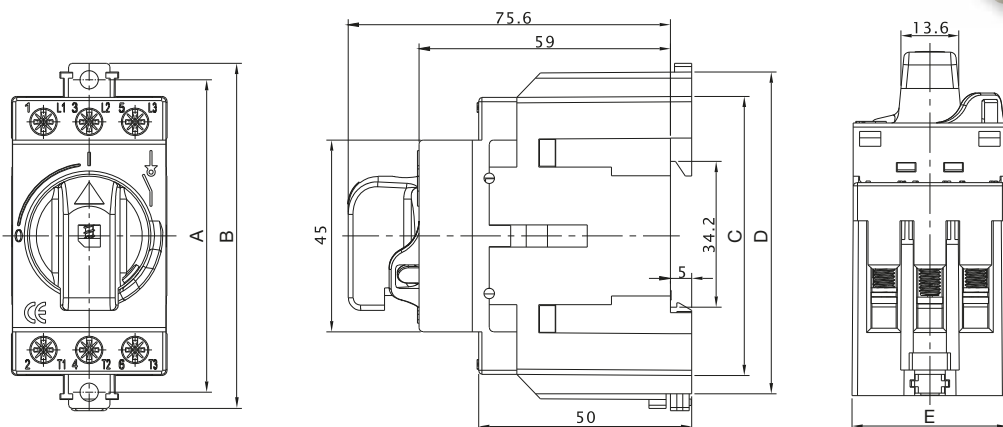

RELEVANT STANDARD
EN 60947-3

EVOSLJL jelzőlámpák

Pm 0,8 VA
20.000 [h]
IP 20
1-25 [mm²]
35×7.5
Ta -25..+55°C

Piktogramok
F/0

TRACON	Un	LED
SLJL-AC230-P	230 V AC	× 1 LED
SLJL-AC230-Z	230 V AC	× 1 LED
SLJL-AC230-S	230 V AC	× 1 LED
SLJL-AC230-F	230 V AC	× 1 LED
SLJL-AC230-K	230 V AC	× 1 LED
SLJL-AC24-P	24 V AC	× 1 LED
SLJL-AC24-Z	24 V AC	× 1 LED
SLJL-AC24-S	24 V AC	× 1 LED
SLJL-AC24-F	24 V AC	× 1 LED
SLJL-AC24-K	24 V AC	× 1 LED
SLJL-AC230-3Z	3×230 V AC	× 3 LED
SLJL-AC230-SZP	3×230 V AC	× 3 LED
SLJL-DC220-P	220 V DC	× 1 LED
SLJL-DC220-Z	220 V DC	× 1 LED
SLJL-DC220-S	220 V DC	× 1 LED
SLJL-DC220-F	220 V DC	× 1 LED
SLJL-DC220-K	220 V DC	× 1 LED
SLJL-DC24-P	24 V DC	× 1 LED
SLJL-DC24-Z	24 V DC	× 1 LED
SLJL-DC24-S	24 V DC	× 1 LED
SLJL-DC24-F	24 V DC	× 1 LED
SLJL-DC24-K	24 V DC	× 1 LED

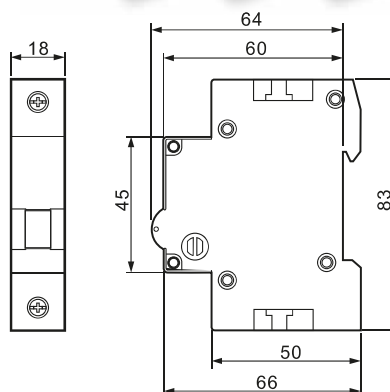

RELEVANT STANDARD
EN 62094-1
EN 60947-5

EVOP moduláris nyomógomb, nyomókapcsoló

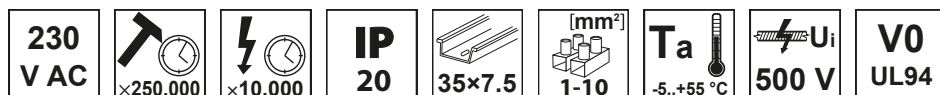

EVOPB

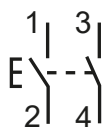

EVOPBL

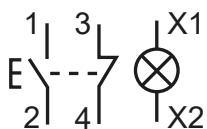

EVOPS

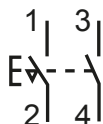

EVOPB2

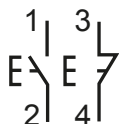

EVOPSL

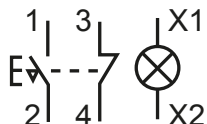

TRACON	I _{th}	I _e (AC-14) (230V AC)	NC NO
EVOPS	16 A	6 A	2 NO
EVOPB	16 A	6 A	2 NO
EVOPB2	16 A	6 A	1 NO, 1 NC
EVOPBL	16 A	6 A	1 NO+1 NC
EVOPSL	16 A	6 A	1 NO+1 NC

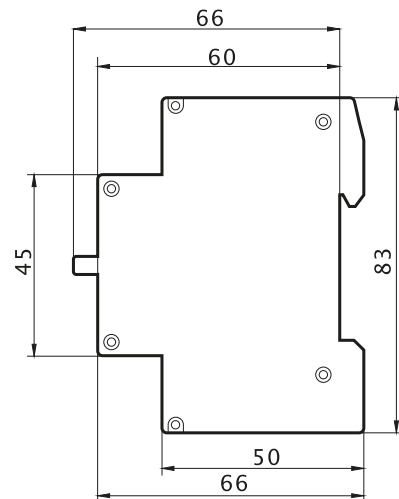

RELEVANT STANDARD
EN 60947-5-1

EVOBT biztonsági (csengő) transzformátor

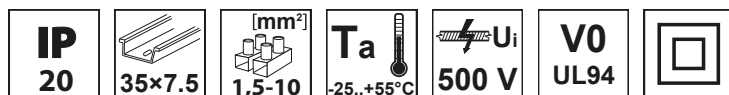

EVOBT15/1



EVOBT30/1

TRACON	P _s	U _{pr}	U _{sec}	I _{sec}
EVOBT15/1	max. 15 VA		4-8-12 V AC	1,25 A
EVOBT24/1	max. 15 VA	230 V AC	12-24 V AC	0,62 A
EVOBT30/1	max. 30 VA		12-12-24 V AC	1,25 A

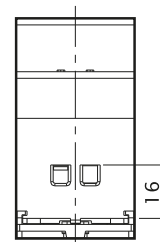
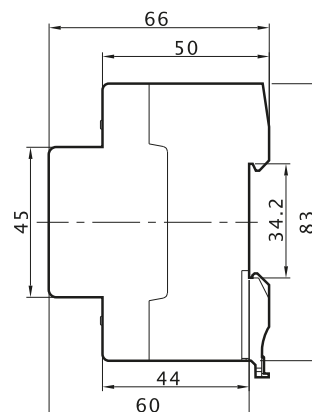
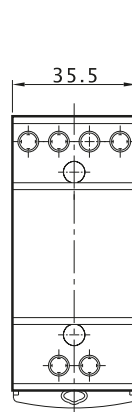

RELEVANT STANDARD
EN 60947-5-1

RELEVANT STANDARD
EN 61558-2-8

EVOHK Installációs kontaktorok

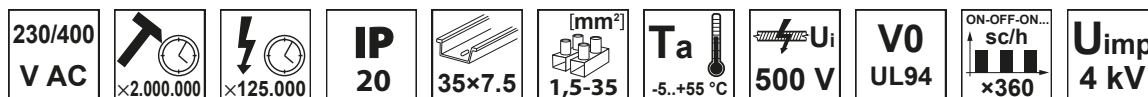

TRACON	U _m	I _n (A)	W (mm)	P _e (kW)				P _s	[Symbol]	[Symbol]	NC NO
				AC1 / AC7a 230V	AC3 / AC7b 230V	AC1 / AC7a 400V	AC3 / AC7b 400V				
EVOHK2-25	230 V AC	25	17,5	5	1,5	–	–	1,35 W	20A gG	2 × NO	
EVOHK2-25-24	24 V AC	25	17,5	5	1,5	–	–	1,35 W	20A gG	2 × NO	
EVOHK2-25V	230 V AC	25	17,5	5	1,5	–	–	1,35 W	20A gG	1 × NO+1 × NC	
EVOHK2-40	230 V AC	40	35,4	9	2,2	–	–	1,55 W	32A gG	2 × NO	
EVOHK2-63	230 V AC	63	35,4	11,6	3,3	–	–	1,55 W	50A gG	2 × NO	
EVOHK2-80	230 V AC	80	54	16	5,5	–	–	1,55 W	63A gG	2 × NO	
EVOHK2-100	230 V AC	100	54	19	6	–	–	1,55 W	80A gG	2 × NO	
EVOHK4-25	230 V AC	25	35	5	1,5	16	4	1,35 W	20A gG	4 × NO	
EVOHK4-25-24	24 V AC	25	35	5	1,5	16	4	1,35 W	20A gG	4 × NO	
EVOHK4-40	230 V AC	40	53,3	9	2,2	27,5	12,5	1,55 W	32A gG	4 × NO	
EVOHK4-63	230 V AC	63	53,3	11,6	3,3	40	15	1,55 W	50A gG	4 × NO	
EVOHK4-80	230 V AC	80	108	16	5,5	50	18,5	1,55 W	63A gG	4 × NO	
EVOHK4-100	230 V AC	100	108	19	6	60	22	1,55 W	80A gG	4 × NO	

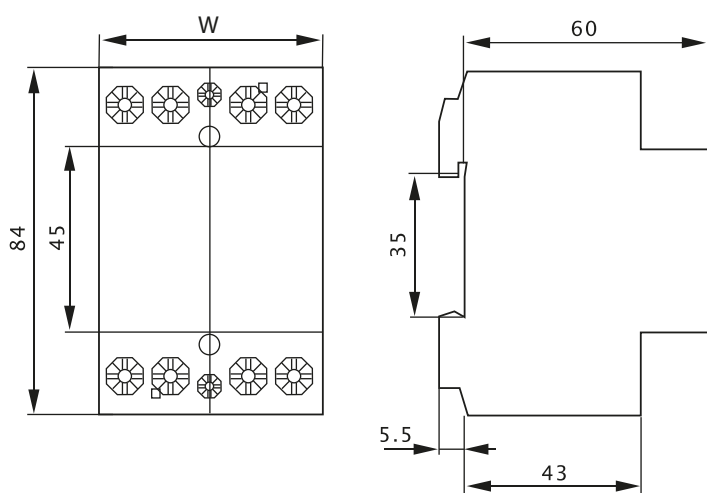

RELEVANT STANDARD
EN 60947-4-1

RELEVANT STANDARD
EN 61095

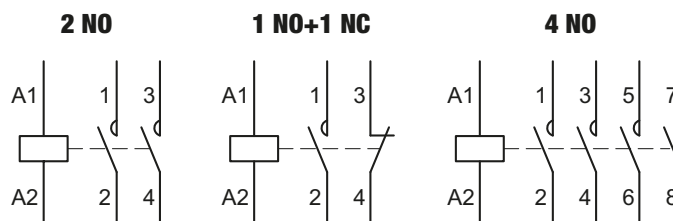

OLVASSA BE A KÓDOT!

- Nézze meg újdonságainkat
- Legyen naprakész

Kínálatunk gyorsan és folyamatosan fejlődik!
Katalógusunk a 2021. áprilisi állapotot tükrözi.
Naprakész információért látogasson el honlapunkra!

Feszültségfigyelő relé



230/400
V AC



IP
20



Piktogramok

F/O

TRACON	2P	4P
	EVOU02	EVOUC2P63
		EVOU04
		EVOU04P63
Névleges feszültség	230 V AC	230 V AC (L-N)
Névleges frekvencia		50 Hz
Névleges áram		40 A (AC 1)
Saját teljesítmény		AC max. 3 VA
Felső feszültségvédelmi szint	265 V (fix)	265 V (L-N) (fix)
Felső visszakapcsolási szint	257 V (fix)	257 V (L-N) (fix)
Alsó feszültségvédelmi szint	175 V (fix)	175 V (L-N) (fix)
Alsó visszakapcsolási szint	180 V (fix)	180 V (L-N) (fix)
Kapcsolási idő		1 s
Bekapcsolási késleltetés		2 s
Visszakapcsolási idő		30 s
Mérési pontatlanság		≤1%
Tömeg	120 g	250 g



EVOU02



EVOU04

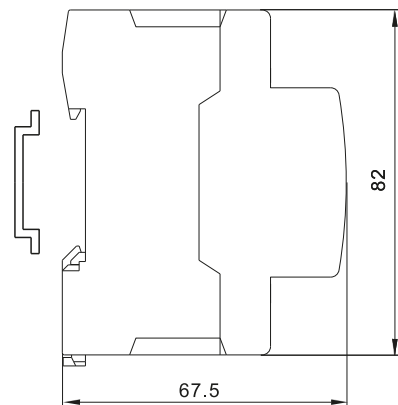
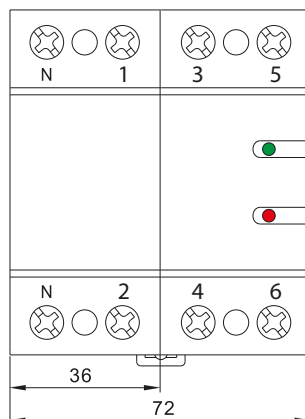

- feszültség növekedés és csökkenés elleni védelem.
- a készülék leválasztja az áramkört a hálózatról, ahogy a határértékeket túllépni a feszültség
- amint a feszültség a határértékeken belülre kerül, 30s elteltével automatikusan visszaadja a feszültséget a hálózatra!
- a működési állapotot LED-ek jelzik

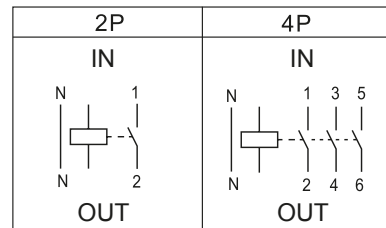
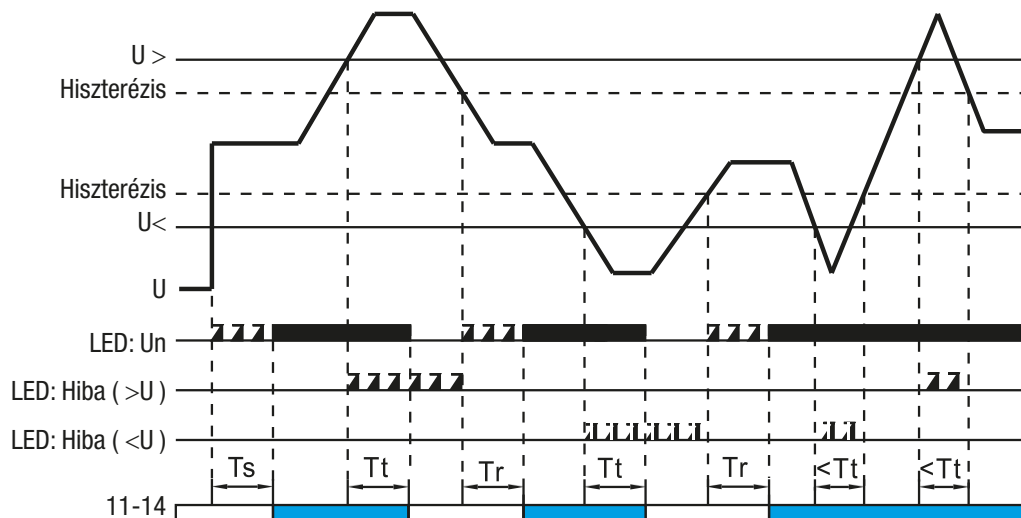

Ts: Működés felfutási idő
Tt: Kikapcsolás késleltetés
Tr: Visszaállási idő

Segédérintkező

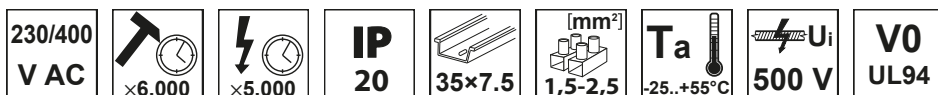

TRACON		I_n (A)	I_n (A)	I_n (A)	I_n (A)	I_n (A)
		(415 V AC)	(240 V AC)	(125 V DC)	(48 V DC)	(24 V DC)
TDZ-F2	TDZ	3 A	6 A	1 A	2 A	4 A

A kismegszakító érintkezőjének bekapcsolt vagy kikapcsolt állapotát jelzi.

Munkaáramú (sönt) kioldó

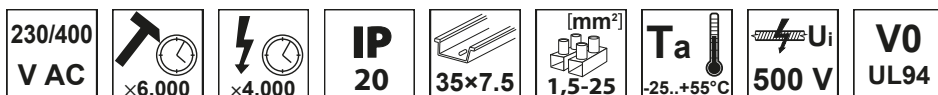

TRACON		U_m
C60-S2	TDZ	110-415 V AC / 110-220 V DC

Az impulzusszerűen rákapcsolt működtető feszültség hatására leoldja a csatlakoztatott kismegszakítót, így távleoldási célokra alkalmas. Kioldás esetén a reset gomb kiugrik és csak ennek visszanyomása után lesz a kismegszakító visszakapcsolható.

Figyelem:
A működtető tekerecs max. 10 sec-ig lehet feszültség alatt!

Feszültségcsökkenési és -növekedési kioldó

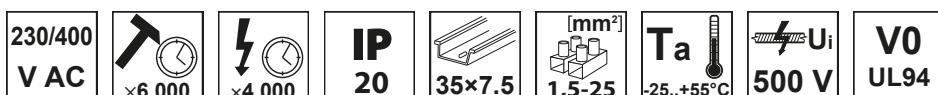

TRACON		U_{up}	U_{down}
C60-U2/02	TDZ	280 V ± 5 %	170 V ± 5 %

A kismegszakítót kioldja, amennyiben a hálózati feszültség eltér a megadott működési tartománytól, ezáltal megóvjaa a védett fogyasztókészüléket a feszültségingadozás káros hatásaitól.

A kismegszakító csak akkor kapcsolható be, ha a kioldó kapcsaira jutó feszültség értéke a működési tartományba (170 V-280 V) esik. Kioldás esetén a reset gomb kiugrik és csak ennek visszanyomása után lesz a kismegszakító visszakapcsolható.

Lakatható retesz sorolható védőkészülékekhez

A lakatható retesz segítségével a sorolható védőkészülékek típusától függően lakat biztosításával reteszelve a „KI” állásban. A retesz 8 - 10 mm széles kezelőkar kivágási szélességi tartományban alkalmazhatók, a kivágás szélső peremének két oldalán a körív legmagasabb pontján 1 - 1,5 mm-es furat szükséges a retesz füleinek rögzítéséhez.

Az alkalmazható lakat maximális kengyelátmérője: 8 mm. A reteszt „BE” állásban használni tilos!

TRACON



MDL

MB, RB, TDZ, KVKM, KVK, KVKVE, TFG, TFIG, TFV, EVO..



DPN (1+N pólusú) kismegszakítók

230/400 V AC	x20.000	x6.000	IP 20	35x7.5	[mm ²] 1,5-10	Ta -25..+55°C	U_i 500 V	V0 UL94		I_{2t} 3	I_{cn} EN 60898 4,5 kA	OFF
-----------------	---------	--------	-----------------	--------	------------------------------	-------------------------	-------------------------------	-------------------	--	----------------------------	---	-----

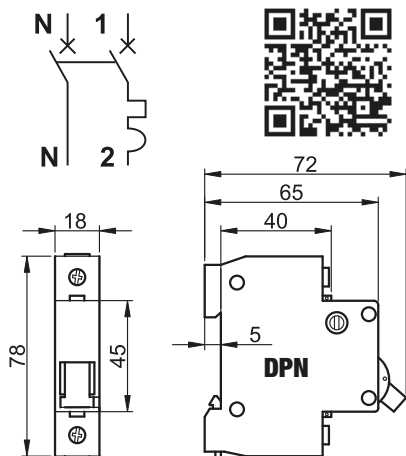

TRACON		I_n (A)
	C	
	DPN-C-6	6
	DPN-C-10	10
	DPN-C-13	13
	DPN-C-16	16
	DPN-C-20	20
	DPN-C-25	25
	DPN-C-32	32

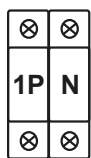

* Kétpólusú készülék, amely egy védett (fázis) és egy kapcsolt nulla (N) pólussal rendelkezik.

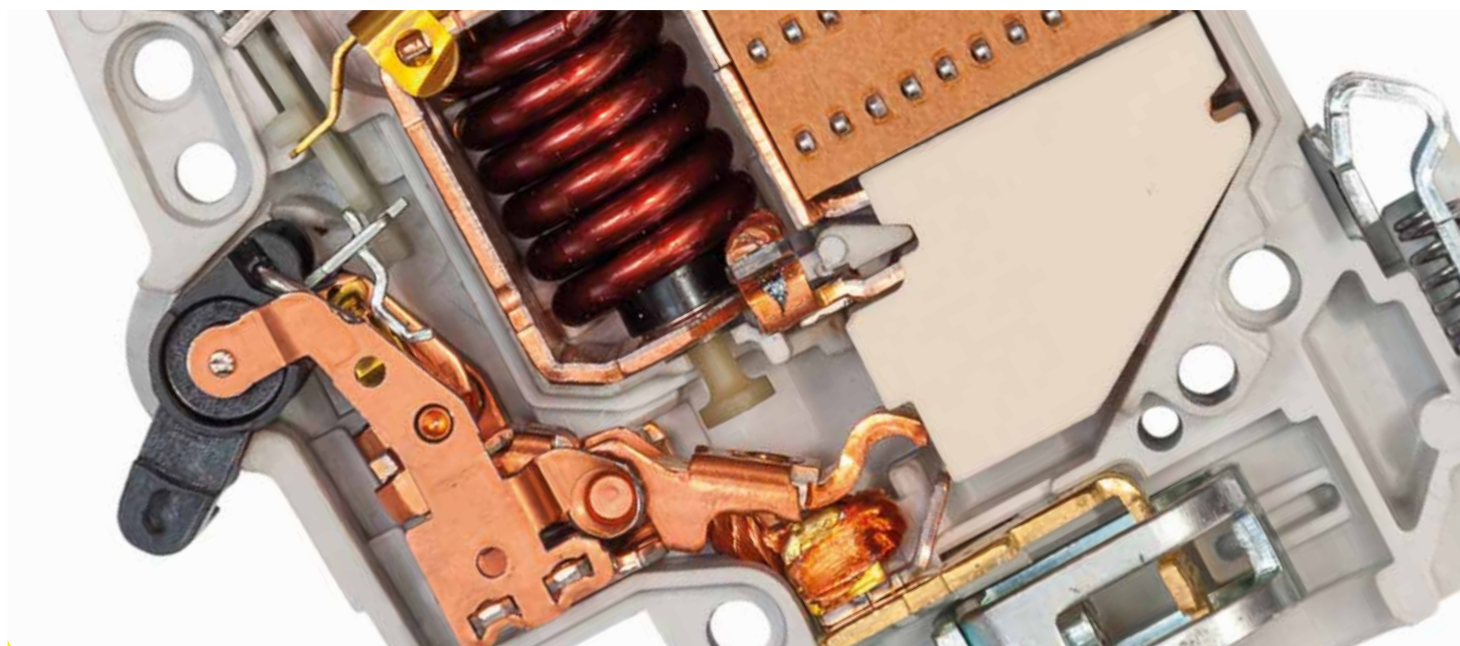

MB kismegszakítók

TRACON			I _n (A)
B	C		
MB-1B-6	MB-1C-6		6
MB-1B-10	MB-1C-10		10
MB-1B-13	MB-1C-13		13
MB-1B-16	MB-1C-16		16
MB-1B-20	MB-1C-20		20
MB-1B-25	MB-1C-25		25
MB-1B-32	MB-1C-32		32
MB-1B-40	MB-1C-40		40
MB-1B-50	MB-1C-50		50
MB-1B-63	MB-1C-63		63
MB-2B-6	MB-2C-6		6
MB-2B-10	MB-2C-10		10
MB-2B-13	MB-2C-13		13
MB-2B-16	MB-2C-16		16
MB-2B-20	MB-2C-20		20
MB-2B-25	MB-2C-25		25
MB-2B-32	MB-2C-32		32
MB-2B-40	MB-2C-40		40
MB-2B-50	MB-2C-50		50
MB-2B-63	MB-2C-63		63

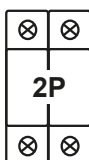
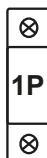

TRACON			I _n (A)
B	C		
MB-3B-6	MB-3C-6		6
MB-3B-10	MB-3C-10		10
MB-3B-13	MB-3C-13		13
MB-3B-16	MB-3C-16		16
MB-3B-20	MB-3C-20		20
MB-3B-25	MB-3C-25		25
MB-3B-32	MB-3C-32		32
MB-3B-40	MB-3C-40		40
MB-3B-50	MB-3C-50		50
MB-3B-63	MB-3C-63		63
-	MB-4C-10		10
-	MB-4C-16		16
-	MB-4C-20		20
-	MB-4C-25		25
-	MB-4C-32		32
-	MB-4C-40		40
-	MB-4C-50		50
-	MB-4C-63		63

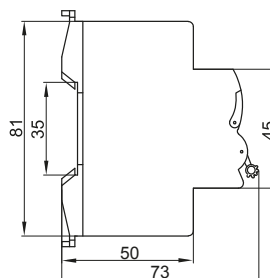
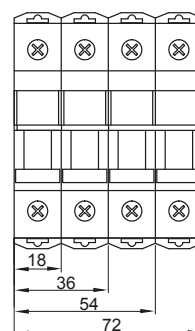
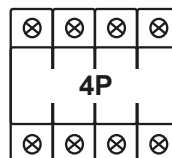

RELEVANT STANDARD
EN 60898

TÜV MEEI TEST DOCUMENTATION
03401-2014183F

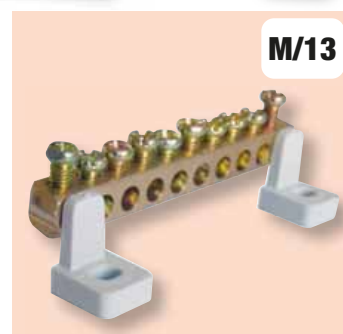
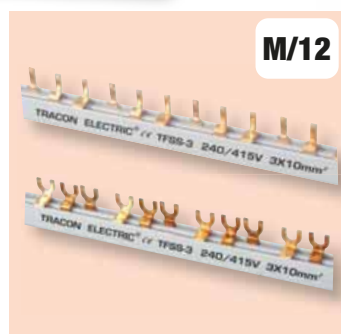
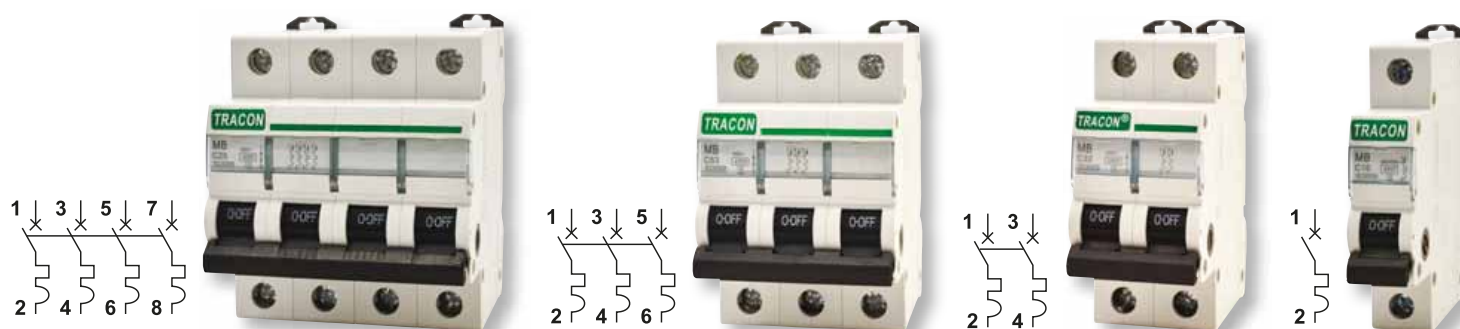

TDZ kismegszakítók

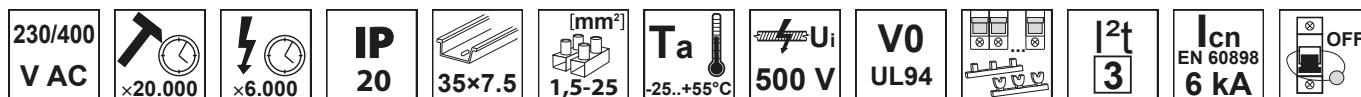

TRACON				I _n (A)
B	C	D		
TDZ-1B-1	TDZ-1C-1	TDZ-1D-1		1
TDZ-1B-2	TDZ-1C-2	TDZ-1D-2		2
TDZ-1B-4	TDZ-1C-4	TDZ-1D-4		4
TDZ-1B-6	TDZ-1C-6	TDZ-1D-6		6
TDZ-1B-10	TDZ-1C-10	TDZ-1D-10		10
TDZ-1B-13	TDZ-1C-13	TDZ-1D-13		13
TDZ-1B-16	TDZ-1C-16	TDZ-1D-16		16
TDZ-1B-20	TDZ-1C-20	TDZ-1D-20		20
TDZ-1B-25	TDZ-1C-25	TDZ-1D-25		25
TDZ-1B-32	TDZ-1C-32	TDZ-1D-32		32
TDZ-1B-40	TDZ-1C-40	TDZ-1D-40		40
TDZ-1B-50	TDZ-1C-50	TDZ-1D-50		50
TDZ-1B-63	TDZ-1C-63	TDZ-1D-63		63
TDZ-2B-1	TDZ-2C-1	TDZ-2D-1		1
TDZ-2B-2	TDZ-2C-2	TDZ-2D-2		2
TDZ-2B-4	TDZ-2C-4	TDZ-2D-4		4
TDZ-2B-6	TDZ-2C-6	TDZ-2D-6		6
TDZ-2B-10	TDZ-2C-10	TDZ-2D-10		10
TDZ-2B-13	TDZ-2C-13	TDZ-2D-13		13
TDZ-2B-16	TDZ-2C-16	TDZ-2D-16		16
TDZ-2B-20	TDZ-2C-20	TDZ-2D-20		20
TDZ-2B-25	TDZ-2C-25	TDZ-2D-25		25
TDZ-2B-32	TDZ-2C-32	TDZ-2D-32		32
TDZ-2B-40	TDZ-2C-40	TDZ-2D-40		40
TDZ-2B-50	TDZ-2C-50	TDZ-2D-50		50
TDZ-2B-63	TDZ-2C-63	TDZ-2D-63		63

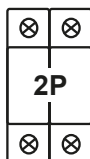

TRACON				I _n (A)
B	C	D		
TDZ-3B-1	TDZ-3C-1	TDZ-3D-1		1
TDZ-3B-2	TDZ-3C-2	TDZ-3D-2		2
TDZ-3B-4	TDZ-3C-4	TDZ-3D-4		4
TDZ-3B-6	TDZ-3C-6	TDZ-3D-6		6
TDZ-3B-10	TDZ-3C-10	TDZ-3D-10		10
TDZ-3B-13	TDZ-3C-13	TDZ-3D-13		13
TDZ-3B-16	TDZ-3C-16	TDZ-3D-16		16
TDZ-3B-20	TDZ-3C-20	TDZ-3D-20		20
TDZ-3B-25	TDZ-3C-25	TDZ-3D-25		25
TDZ-3B-32	TDZ-3C-32	TDZ-3D-32		32
TDZ-3B-40	TDZ-3C-40	TDZ-3D-40		40
TDZ-3B-50	TDZ-3C-50	TDZ-3D-50		50
TDZ-3B-63	TDZ-3C-63	TDZ-3D-63		63
TDZ-4B-1	TDZ-4C-1	TDZ-4D-1		1
TDZ-4B-2	TDZ-4C-2	TDZ-4D-2		2
TDZ-4B-4	TDZ-4C-4	TDZ-4D-4		4
TDZ-4B-6	TDZ-4C-6	TDZ-4D-6		6
TDZ-4B-10	TDZ-4C-10	TDZ-4D-10		10
TDZ-4B-13	TDZ-4C-13	TDZ-4D-13		13
TDZ-4B-16	TDZ-4C-16	TDZ-4D-16		16
TDZ-4B-20	TDZ-4C-20	TDZ-4D-20		20
TDZ-4B-25	TDZ-4C-25	TDZ-4D-25		25
TDZ-4B-32	TDZ-4C-32	TDZ-4D-32		32
TDZ-4B-40	TDZ-4C-40	TDZ-4D-40		40
TDZ-4B-50	TDZ-4C-50	TDZ-4D-50		50
TDZ-4B-63	TDZ-4C-63	TDZ-4D-63		63

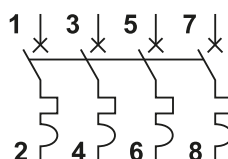
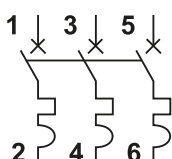
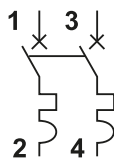
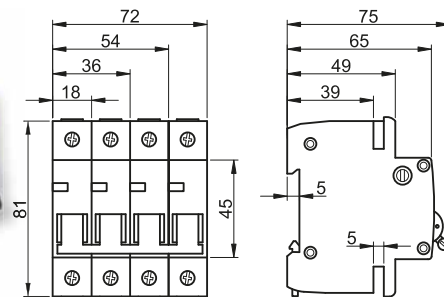
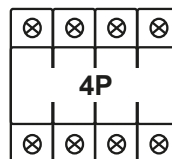

RELEVANT STANDARD
EN 60898



DC kismegszakítók egyenáramú villamos hálózatokhoz

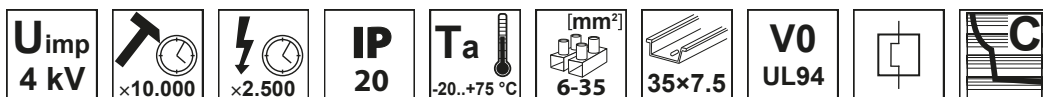

TRACON	U_i	U_e (6kV)	U_e (10kV)	I_{cu} EN 60898-2	I_{cu} EN 60947-2
DC-1C-..	500 V DC	125 V, 250 V	110 V, 220 V	6 kA	10 kA
DC-2C-..	500 V DC	250 V, 500 V	220 V, 440 V	6 kA	10 kA
DC-3C-..	1000 V DC	375 V, 750 V	330 V, 660 V	6 kA	10 kA
DC-4C-..	1000 V DC	500 V, 1000 V	440 V, 880 V	6 kA	10 kA

TRACON	I_n (A)
DC-1C-6	6
DC-1C-10	10
DC-1C-13	13
DC-1C-16	16
DC-1C-20	20
DC-1C-25	25
DC-1C-32	32
DC-1C-40	40
DC-1C-50	50
DC-1C-63	63
DC-2C-6	6
DC-2C-10	10
DC-2C-13	13
DC-2C-16	16
DC-2C-20	20
DC-2C-25	25
DC-2C-32	32
DC-2C-40	40
DC-2C-50	50
DC-2C-63	63

TRACON	I_n (A)
DC-3C-6	6
DC-3C-10	10
DC-3C-13	13
DC-3C-16	16
DC-3C-20	20
DC-3C-25	25
DC-3C-32	32
DC-3C-40	40
DC-3C-50	50
DC-3C-63	63
DC-4C-6	6
DC-4C-10	10
DC-4C-13	13
DC-4C-16	16
DC-4C-20	20
DC-4C-25	25
DC-4C-32	32
DC-4C-40	40
DC-4C-50	50
DC-4C-63	63

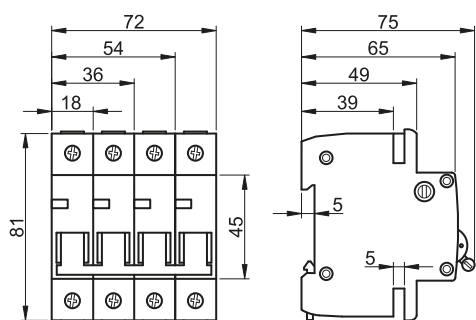

TÜV MEEI TEST DOCUMENTATION
28216230 001

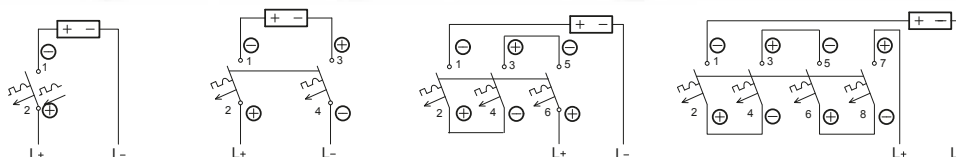

OLVASSA BE A KÓDOT!

- Nézze meg újdonságainkat
- Legyen naprakész

Kínálatunk gyorsan és folyamatosan fejlődik!
Katalógusunk a 2021. áprilisi állapotot tükrözi.
Naprakész információért
látogasson el honlapunkra!

KMH nagyáramú túláramvédelmi megszakítók

230/400 V AC	$\times 10.000$	$\times 4.000$	IP 20	35x7.5	[mm ²] 16-35	Ta -25..+55°C	U_i 500 V	V0 UL94		I_{2t} 3	I_{cn} EN 60898 6 kA	
-----------------	-----------------	----------------	--------------	--------	--------------------------	----------------------	----------------------------	----------------	--	-------------------------	-------------------------------------	--

TRACON		I_n (A)
	KMH-163	63
	KMH-180	80
	KMH-1100	100
	KMH-1125	125

TRACON		I_n (A)
	KMH-363	63
	KMH-380	80
	KMH-3100	100
	KMH-3125	125

TRACON		I_n (A)
	KMH-263	63
	KMH-280	80
	KMH-2100	100
	KMH-2125	125

TRACON		I_n (A)
	KMH-463	63
	KMH-480	80
	KMH-4100	100
	KMH-4125	125

TRACON		I_n (A)
	KMH-263	63
	KMH-280	80
	KMH-2100	100
	KMH-2125	125

TRACON		I_n (A)
	KMH-463	63
	KMH-480	80
	KMH-4100	100
	KMH-4125	125

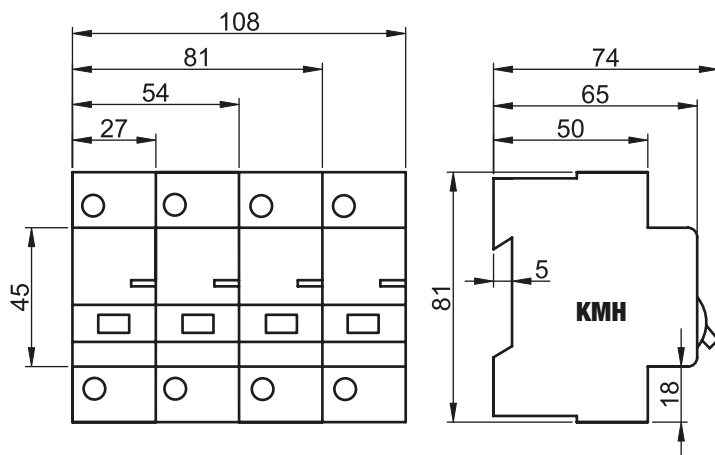
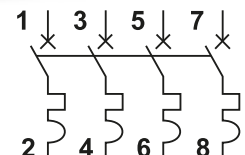
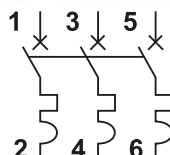
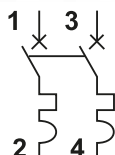

Kioldási jelleggörbe

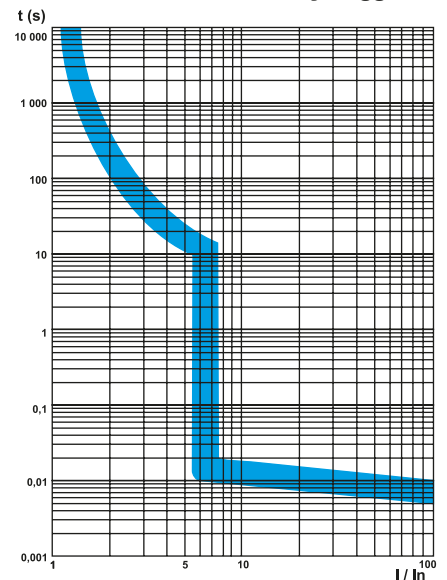

RELEVANT STANDARD
EN 60898

KVKVE kombinált védőkapcsoló 1 modul szélességben

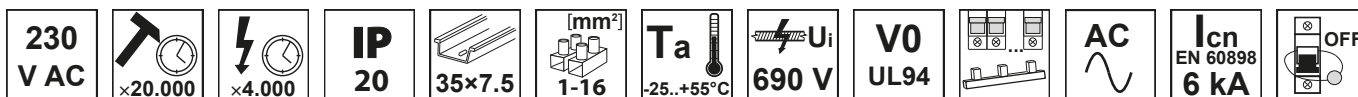

TRACON		I _n (A)	I Δ _n (mA)
B	C		
KVKVEB-6/30	KVKVE-6/30	6	30
KVKVEB-6/100	KVKVE-6/100	6	100
KVKVEB-10/30	KVKVE-10/30	10	30
KVKVEB-10/100	KVKVE-10/100	10	100
KVKVEB-13/30	KVKVE-13/30	13	30
KVKVEB-13/100	KVKVE-13/100	13	100
KVKVEB-16/30	KVKVE-16/30	16	30
KVKVEB-16/100	KVKVE-16/100	16	100
KVKVEB-20/30	KVKVE-20/30	20	30
KVKVEB-20/100	KVKVE-20/100	20	100
KVKVEB-25/30	KVKVE-25/30	25	30
KVKVEB-25/100	KVKVE-25/100	25	100
KVKVEB-32/30	KVKVE-32/30	32	30
KVKVEB-32/100	KVKVE-32/100	32	100

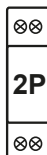

Kioldási jelleggörbe

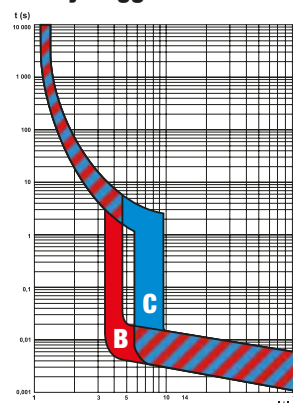

E3

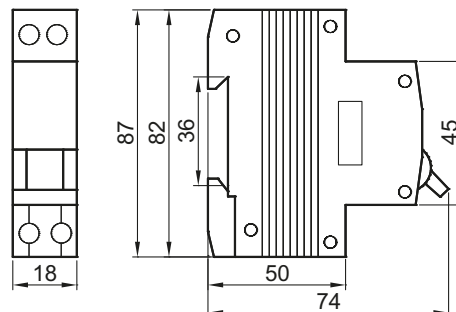

RELEVANT STANDARD
EN 61009-1

KVK kombinált áramvédő kapcsolók

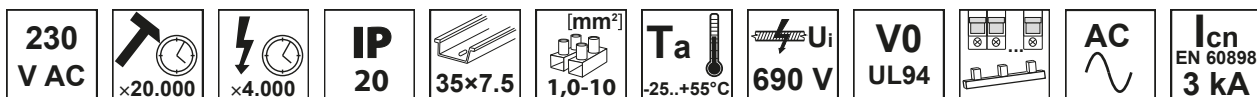

TRACON		I _n (A)	I Δ _n (mA)
B	C		
KVKB-6/03	KVK-6/03	6	30
KVKB-6/10	KVK-6/10	6	100
KVKB-6/30	KVK-6/30	6	300
KVKB-10/03	KVK-10/03	10	30
KVKB-10/10	KVK-10/10	10	100
KVKB-10/30	KVK-10/30	10	300
KVKB-16/03	KVK-16/03	16	30
KVKB-16/10	KVK-16/10	16	100
KVKB-16/30	KVK-16/30	16	300
KVKB-20/03	KVK-20/03	20	30
KVKB-20/10	KVK-20/10	20	100
KVKB-20/30	KVK-20/30	20	300
KVKB-25/03	KVK-25/03	25	30
KVKB-25/10	KVK-25/10	25	100
KVKB-25/30	KVK-25/30	25	300
KVKB-32/03	KVK-32/03	32	30
KVKB-32/10	KVK-32/10	32	100
KVKB-32/30	KVK-32/30	32	300

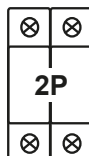

Kioldási jelleggörbe

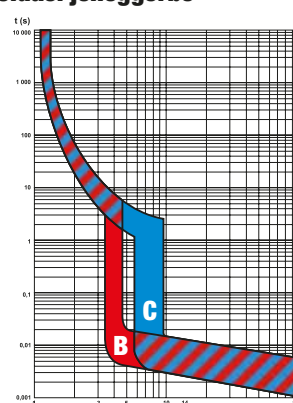

E3

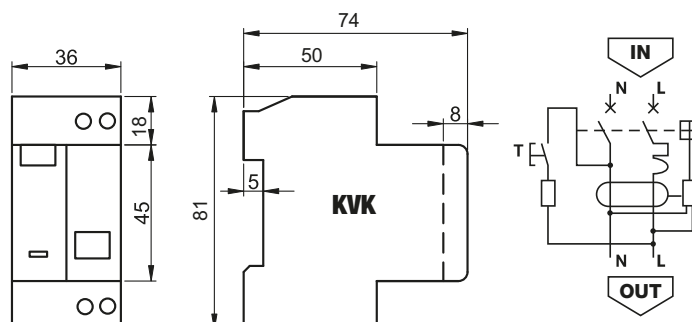

KVKM kombinált védőkapcsolók, elektromechanikus

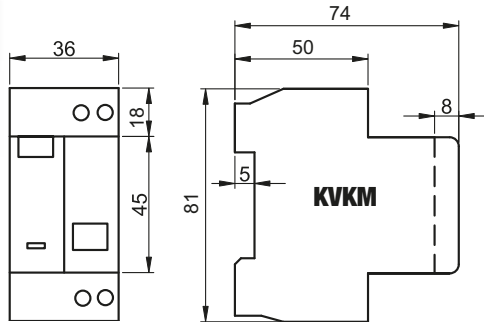
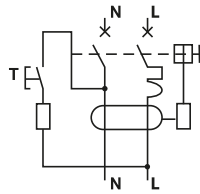
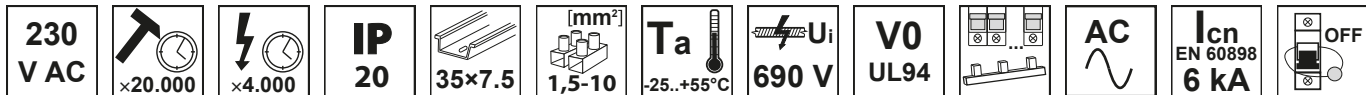

TRACON		I _n (A)	I Δ _n (mA)
B	C		
KVKMB-6/030	KVKM-6/030	6	30
KVKMB-6/100	KVKM-6/100	6	100
KVKMB-6/300	KVKM-6/300	6	300
KVKMB-10/030	KVKM-10/030	10	30
KVKMB-10/100	KVKM-10/100	10	100
KVKMB-10/300	KVKM-10/300	10	300
KVKMB-16/030	KVKM-16/030	16	30
KVKMB-16/100	KVKM-16/100	16	100
KVKMB-16/300	KVKM-16/300	16	300
KVKMB-20/030	KVKM-20/030	20	30
KVKMB-20/100	KVKM-20/100	20	100
KVKMB-20/300	KVKM-20/300	20	300
KVKMB-25/030	KVKM-25/030	25	30
KVKMB-25/100	KVKM-25/100	25	100
KVKMB-25/300	KVKM-25/300	25	300
KVKMB-32/030	KVKM-32/030	32	30
KVKMB-32/100	KVKM-32/100	32	100
KVKMB-32/300	KVKM-32/300	32	300
KVKMB-40/030	KVKM-40/030	40	30
KVKMB-40/100	KVKM-40/100	40	100
KVKMB-40/300	KVKM-40/300	40	300



Az elektromechanikus kombinált védőkapcsoló nulla-vezeték szakadás esetén is védelmet nyújt az áramütés ellen!

RB áram-védőkapcsolók

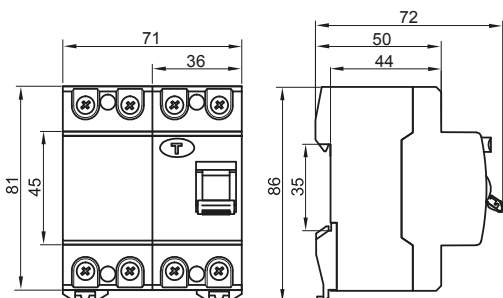
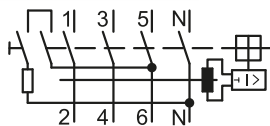
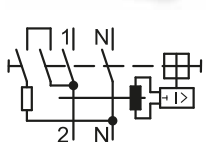
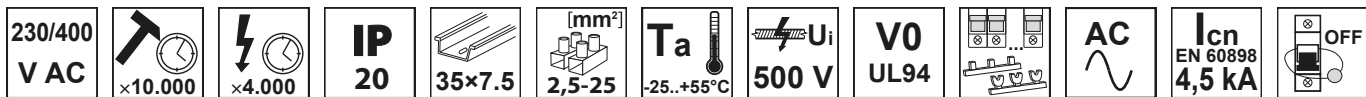

TRACON	I _n (A)	I Δ _n (mA)
RB2-25030	25	30
RB2-25100	25	100
RB2-25300	25	300
RB2-25500	25	500
RB2-40030	40	30
RB2-40100	40	100
RB2-40300	40	300
RB2-40500	40	500
RB4-25030	25	30
RB4-25100	25	100
RB4-25300	25	300
RB4-25500	25	500
RB4-40030	40	30
RB4-40100	40	100
RB4-40300	40	300
RB4-40500	40	500
RB4-63030	63	30
RB4-63100	63	100
RB4-63300	63	300
RB4-63500	63	500

TFV áram-védőkapcsolók

230/400 V AC
 $\times 10.000$
 $\times 4.000$
IP 20
35x7.5
[mm²] 2,5-25
Ta -25..+55°C
500 V
V0 UL94
AC
Icn EN 60898 6 kA
OFF

TRACON	I _n (A)	I Δ _n (mA)
TFV2-16030	16	30
TFV2-16100	16	100
TFV2-16300	16	300
TFV2-25030	25	30
TFV2-25100	25	100
TFV2-25300	25	300
TFV2-40030	40	30
TFV2-40100	40	100
TFV2-40300	40	300
TFV2-63030	63	30
TFV2-63100	63	100
TFV2-63300	63	300
TFV4-16030	16	30
TFV4-16100	16	100
TFV4-16300	16	300
TFV4-25030	25	30
TFV4-25100	25	100
TFV4-25300	25	300
TFV4-40030	40	30
TFV4-40100	40	100
TFV4-40300	40	300
TFV4-63030	63	30
TFV4-63100	63	100
TFV4-63300	63	300

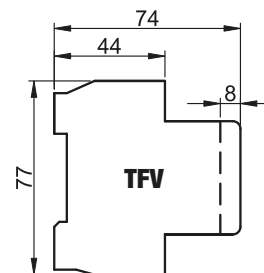
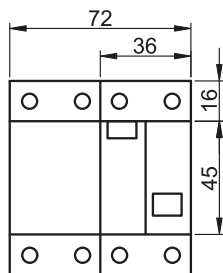
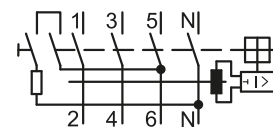
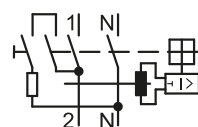
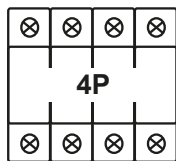
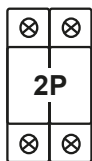

TFVH nagyáramú áram-védőkapcsolók

230/400 V AC
 $\times 10.000$
 $\times 4.000$
IP 20
35x7.5
[mm²] 2,5-50
Ta -25..+55°C
500 V
V0 UL94
AC
Icn EN 60898 6 kA
OFF

TRACON	I _n (A)	I Δ _n (mA)
TFVH4-80030	80	30
TFVH4-80100	80	100
TFVH4-80300	80	300
TFVH4-100030	100	30
TFVH4-100100	100	100
TFVH4-100300	100	300

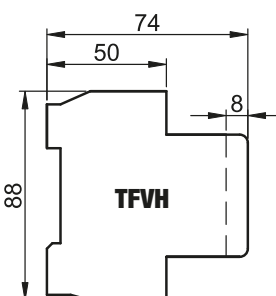
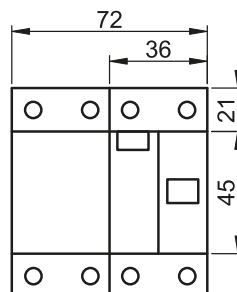
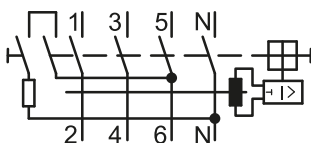
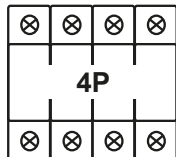

TÜV MEEI TEST DOCUMENTATION
M1 2792130 01

TFG áram-védőkapcsolók

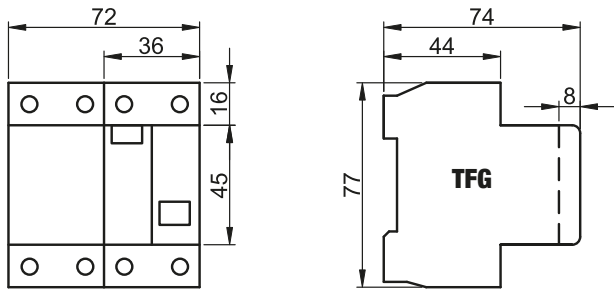
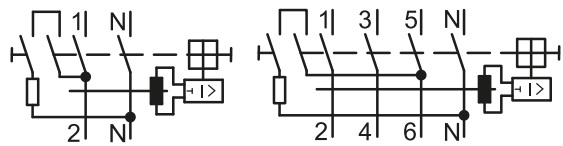
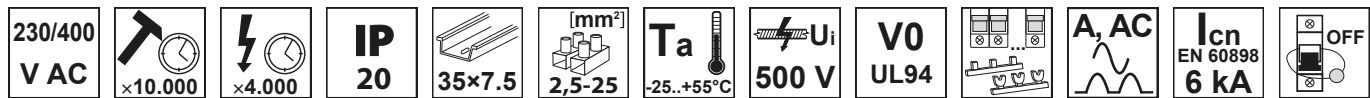

RELEVANT STANDARD
EN 61008-1

TRACON	I _n (A)	I Δ _n (mA)
TFG2-16030	16	30
TFG2-16100	16	100
TFG2-16300	16	300
TFG2-25030	25	30
TFG2-25100	25	100
TFG2-25300	25	300
TFG2-40030	40	30
TFG2-40100	40	100
TFG2-40300	40	300
TFG2-63030	63	30
TFG2-63100	63	100
TFG2-63300	63	300
TFG4-16030	16	30
TFG4-16100	16	100
TFG4-16300	16	300
TFG4-25030	25	30
TFG4-25100	25	100
TFG4-25300	25	300
TFG4-40030	40	30
TFG4-40100	40	100
TFG4-40300	40	300
TFG4-63030	63	30
TFG4-63100	63	100
TFG4-63300	63	300

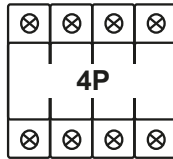
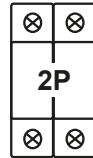

TFGA áramvédőkapcsolós adapter

TRACON		I _n (A)	I Δ _n (mA)	P _{max}	IP..
TFGA-1		16	30	3.600 W	IP 40
TFGA-1F		16	30	3.600 W	IP 40
TFGA-4F		16	30	3.600 W	IP 44

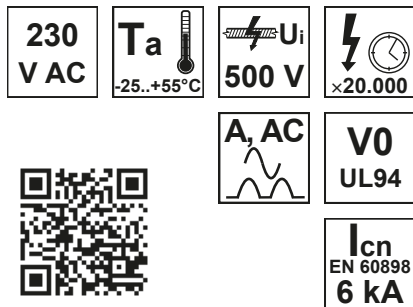

TÜV MEEI TEST DOCUMENTATION
M1 2792130 01

ETL-SEMKO CERTIFICATE NO.
630406

A TFGA – típusú áram-védőkapcsolós adapter a védővezetős rendszerű hálózatokban, a közvetett érintés elleni védelem egyik legkorszerűbb eszköze, sőt néhány esetben a közvetlen érintés ellen is védelmet nyújt. A védőkapcsoló automatikusan működésbe lép, ha a védendő hálózatban a kialakuló hibaáram nagysága eléri a kritikus értéket. Hordozható kiviteléből következően használható minden olyan hálózatnál, ami nem rendelkezik beépített áram-védőkapcsolós védelemmel.

A készüléket a RESET gomb megnyomásával tudjuk bekapcsolni. Az első használat előtt ellenőrizni kell a készüléket a TEST gomb segítségével, melynek hatására az adapternek le kell kapcsolnia az aljzatot a hálózatról. Állandó használat esetén a készüléket havonta legalább egyszer ellenőrizni kell a TEST gomb segítségével. Az adapter csatlakoztatását követően a védeni kívánt hálózatot (készüléket) csatlakoztatni kell a készülék aljzatába. A készülék feszültség kimaradás esetén kikapcsol, a feszültség visszatérésekor a RESET gomb megnyomásával újra be kell kapcsolni.

Áram-védőkapcsoló, motoros automata visszakapcsoló készülékkel

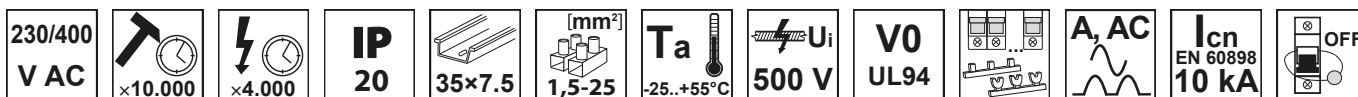

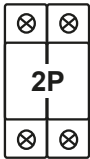
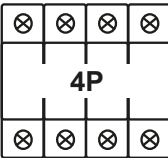
TRACON				I _n (A)
	IΔn= 30 mA	IΔn= 100 mA	IΔn= 300 mA	
	TFIG2-16030	TFIG2-16100	TFIG2-16300	16
	TFIG2-25030	TFIG2-25100	TFIG2-25300	25
	TFIG2-40030*	TFIG2-40100*	TFIG2-40300	40
	TFIG2-63030	TFIG2-63100	TFIG2-63300	63
	TFIG4-16030	TFIG4-16100	TFIG4-16300	16
	TFIG4-25030	TFIG4-25100	TFIG4-25300	25
	TFIG4-40030	TFIG4-40100*	TFIG4-40300	40
	TFIG4-63030	TFIG4-63100	TFIG4-63300*	63
	TFIG4-80030	TFIG4-80100	TFIG4-80300	80



* raktáron, egyéb változatok külön rendelésre 4 hét szállítási határidővel

A készülék az esetlegesen fellépő magas hibaáram vagy légköri jelenség túlárama által kioldott eszköz automatikus visszakapcsolására használható az áramkörben folyó szinuszos vagy lüktető egyenáramú hibaáramok megfelelő szintre való lecsökkenése után.

A termék használata olyan, állandó felügyeletű kezelőszemélyzet nélkül működő berendezéseknél javasolt, ahol a védőkészülék kikapcsolása hosszú idejű leállást okoz a kezelőszemélyzet lassú helyszínre érkezése miatt (telekommunikációs állomások, jelzőlámpa vezérlések, távoli kapcsoló berendezések).

A kioldást okozó hibajelenség gyakran hamar elmúlik és ilyenkor a leállítás indokolatlan és komoly veszteségeket okoz.

A visszakapcsoló beszerelése és beállítása könnyen elvégezhető, a működéshez elég oldalra elhúzni a tolókapcsolót az előlapon az önműködő állapot kiválasztásához.

Amennyiben a készülék a beállított visszakapcsolások (1-8) során sem tudja az áram-védőkapcsolót bekapcsolt helyzetbe állítani, akkor kikapcsolt állapotban marad. A készülék különböző állapotainak távjelzése a beépített segédérintkezőkkel lehetséges.

A hibamentes hálózati állapot visszaállása után az áram-védőkapcsoló manuálisan is visszakapcsolható. Karbantartás esetén a kezelőnek a visszakapcsoló előlapján lévő tolókapcsolót OFF (KI) állásba kell állítania lekapcsolás előtt, különben a készülék automatikusan visszakapcsol! Különleges igény esetén lakatolható változat is rendelhető a nem kívánt visszakapcsolás megakadályozása érdekében.

Részletes működési leírás a termék használati útmutatójában!

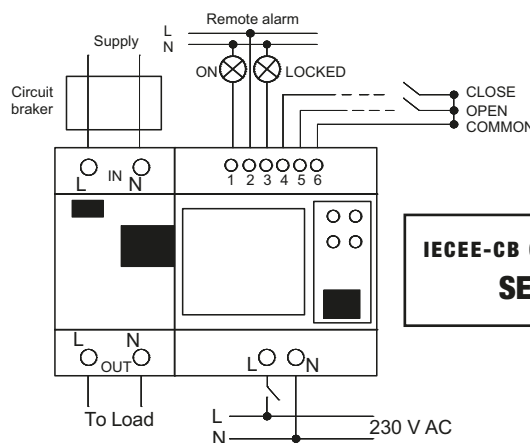

**IECEE-CB CERTIFICATE NO.
SE-58939**

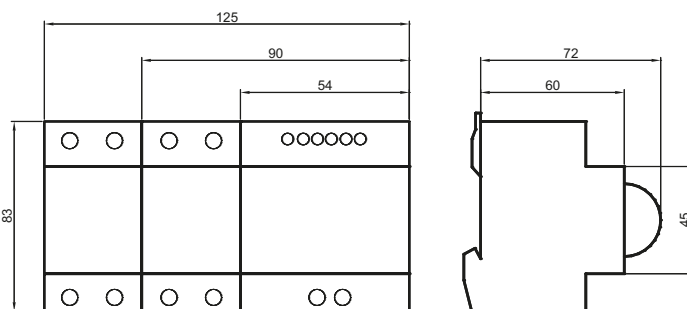

Műszaki adatok	Áram-védőkapcsoló	Motoros automata visszakapcsoló
Állítható visszakapcsolások száma	–	1, 2, 4, 6, 8
Kioldási idő / Kikapcsolási idő	0,1 s	1 s
Bekapcsolási idő	–	2 s
Állítható visszakapcsolás-késleltetési idő	–	10 – 30 – 60 – 120 – 180 s
LED-es működés-visszajelző	–	Zöld: BE (üzem), Piros: KI (retesztelt), Villogó piros: a kioldó visszakapcsolás alatt
Manuális ki-bekapcsolás	Kezelőkarral	tolókapcsolóval
A segédérintkező terhelhetősége	–	250 V AC, 5 A
Táv működtető bemenet	–	NC / NO / CO

Installációs kontaktorok

230/400 V AC			IP 20			Ta -25...+55°C		V0 UL94		
-----------------	--	--	--------------	--	--	--------------------------	--	----------------	--	--

TRACON	U _m	I _n (A)	W (mm)	P _e (kW)				P _s			NC NO	
				AC1/AC7a 230V	AC3/AC7b 230V	AC1/AC7a 400V	AC3/AC7b 400V					
SHK2-25	230 V AC	25	18	5 kW	1,5 kW	-	-	1,35 W	20A gG	2 × NO	1-6	
SHK2-25V11	230 V AC	25	18	5 kW	1,5 kW	-	-	1,35 W	20A gG	1 × NO+1 × NC	1-6	
SHK2-25-24	24 V AC	25	18	5 kW	1,5 kW	-	-	1,35 W	20A gG	2 × NO	1-6	
SHK2-40	230 V AC	40	36	9 kW	2,2 kW	-	-	1,55 W	32A gG	2 × NO	2,5-25	
SHK2-40V11	230 V AC	40	36	9 kW	2,2 kW	-	-	1,55 W	32A gG	1 × NO+1 × NC	2,5-25	
SHK2-63	230 V AC	63	36	14 kW	5,5 kW	-	-	1,55 W	50A gG	2 × NO	2,5-25	
SHK2-63V11	230 V AC	63	36	14 kW	5,5 kW	-	-	1,55 W	50A gG	1 × NO+1 × NC	2,5-25	
SHK3-25	230 V AC	25	36	5 kW	1,5 kW	9,5 kW	3,4 kW	1,35 W	20A gG	3 × NO	1-6	
SHK3-40	230 V AC	40	54	9 kW	2,2 kW	16 kW	4 kW	1,55 W	32A gG	3 × NO	2,5-25	
SHK3-63	230 V AC	63	54	14 kW	5,5 kW	24 kW	9 kW	1,55 W	50A gG	3 × NO	2,5-25	
SHK4-25	230 V AC	25	36	5 kW	1,5 kW	9,5 kW	3,4 kW	1,35 W	20A gG	4 × NO	1-6	
SHK4-25V22	230 V AC	25	36	5 kW	1,5 kW	9,5 kW	3,4 kW	1,35 W	20A gG	2 × NO+2 × NC	1-6	
SHK4-40	230 V AC	40	54	9 kW	2,2 kW	16 kW	4 kW	1,55 W	32A gG	4 × NO	2,5-25	
SHK4-40V22	230 V AC	40	54	9 kW	2,2 kW	16 kW	4 kW	1,55 W	32A gG	2 × NO+2 × NC	2,5-25	
SHK4-63	230 V AC	63	54	14 kW	5,5 kW	24 kW	9 kW	1,55 W	50A gG	4 × NO	2,5-25	
SHK4-63V22	230 V AC	63	54	14 kW	5,5 kW	24 kW	9 kW	1,55 W	50A gG	2 × NO+2 × NC	2,5-25	
SHK2-25K	230 V AC	25	18	5 kW	1,5 kW	-	-	1,35 W	20A gG	2 × NO	1-6	
SHK2-40K	230 V AC	40	36	9 kW	2,2 kW	-	-	1,55 W	32A gG	2 × NO	2,5-25	
SHK2-63K	230 V AC	63	36	14 kW	5,5 kW	-	-	1,55 W	50A gG	2 × NO	2,5-25	
SHK4-25K	230 V AC	25	36	5 kW	1,5 kW	9,5 kW	3,4 kW	1,35 W	20A gG	4 × NO	1-6	
SHK4-40K	230 V AC	40	54	9 kW	2,2 kW	16 kW	4 kW	1,55 W	32A gG	4 × NO	2,5-25	
SHK4-63K	230 V AC	63	54	14 kW	5,5 kW	24 kW	9 kW	1,55 W	50A gG	4 × NO	2,5-25	

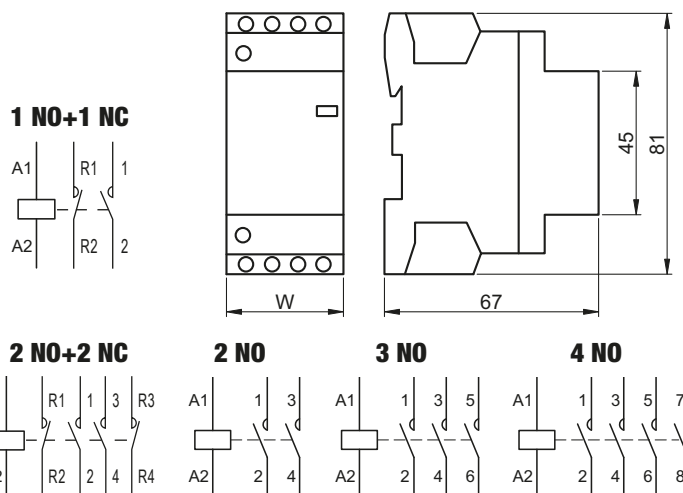

Segédértkező SHK kontaktorhoz

TRACON	U _m	I _n (A)	W (mm)	AC12 (230V)	AC15 (230V)	DC13 (130V)		
SHK-S11	230 V AC	5 A	9 mm	5 A (AC12)	2 A (AC15)	1 A	1 × NO + 1 × NC	1-6 mm ²
SHK-S20	230 V AC	5 A	9 mm	5 A (AC12)	2 A (AC15)	1 A	2 × NO	1-6 mm ²

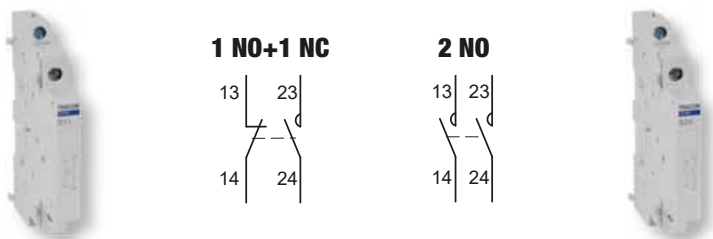

Lépcsőházi időkapcsoló

230 V AC	1-2,5 mm²	IP 20	T_a -20...+55°C	35x7.5	1xCO	x40.000	U_i 500 V	V0 UL94	Piktogramok F/O
-----------------	-----------------------------	--------------	----------------------------------	---------------	-------------	----------------	----------------------------	----------------	------------------------

TRACON		P _s	I _n	L	Σ	P _{max}	
TLA-3	30 sec – 12 min	1 VA	16 A (cos φ = 1)	max. 250 m	max. x 50	max. 2.300 W	max. 800 W
NARS	30 sec – 20 min	1.5 VA	16 A (cos φ = 1)	max. 250 m	max. x 50	max. 2.000 W	max. 400 W

Alkalmazás

- Világítás késleltetett kikapcsolása folyosókon, bejáratnál, lépcsőházakban, termekben, csarnokokban vagy ventilátorok késleltetése (WC, fürdőszoba, stb.)

RELEVANT STANDARD EN 60730

RELEVANT STANDARD EN 60669-2

3-vezetékes bekötés

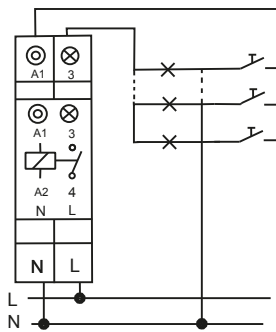

4-vezetékes bekötés

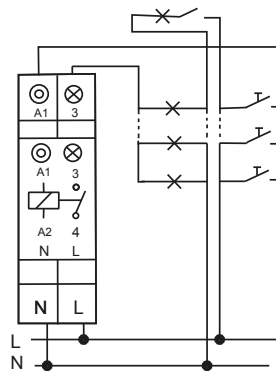

3-vezetékes bekötés

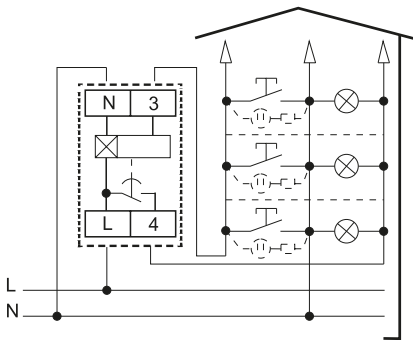

4-vezetékes bekötés

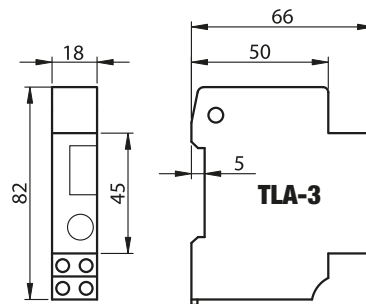
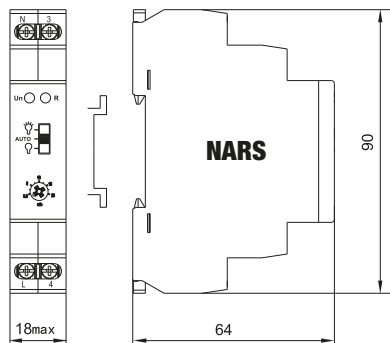
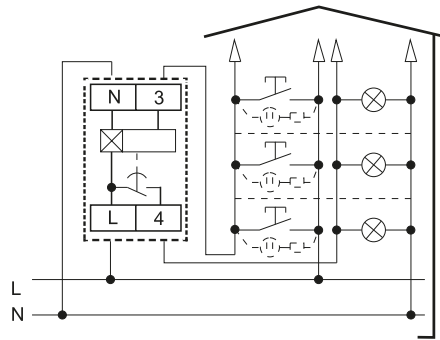

OLVASSA BE A KÓDOT!

- Nézze meg újdonságainkat
- Legyen naprakész

**Kínálatunk gyorsan és folyamatosan fejlődik!
Katalógusunk a 2021. áprilisi állapotot tükrözi.
Naprakész információért látogasson el honlapunkra!**

Impulzusrelék

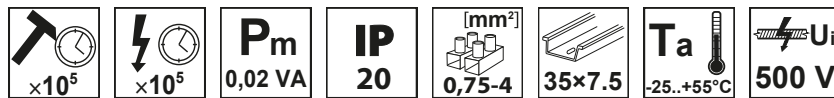

TRACON	U _m	P _{max}		cosφ=1	cosφ=0,6
IMP-12	12 V AC	max. 3.500 W	max. 1.300 W	× 100.000	× 50.000
IMP-24	24 V AC	max. 3.500 W	max. 1.300 W	× 100.000	× 50.000
IMP-230	230 V AC	max. 3.500 W	max. 1.300 W	× 100.000	× 50.000
NARIMP	AC/DC12V-240V	max. 2.000 W	max. 900 W	× 500.000	× 250.000



IMP-..

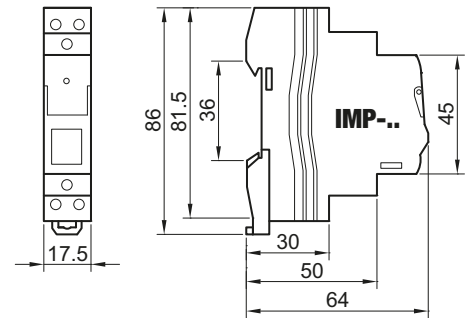
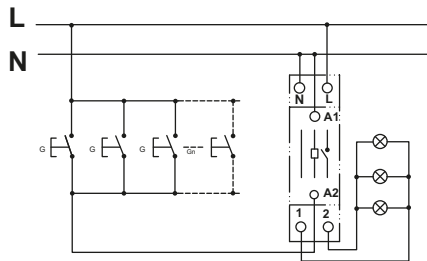

Alkalmazás

Impulzusrelé, nyomógombokkal különböző helyekről vezérelhető. A keresztkapcsolókat helyettesítheti a nyomógombvezérlésnek köszönhetően (gyakorlatilag korlátozás nélkül két párhuzamos vezetékre csatlakoztatva). A szerelés sokkal átláthatóbb és gyorsabb a szerelő számára.



NARIMP

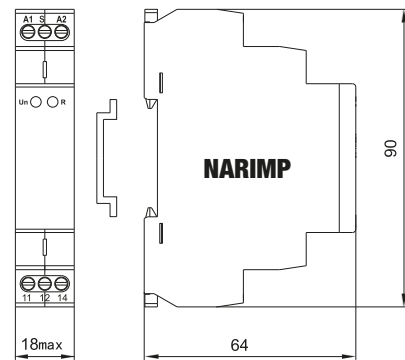
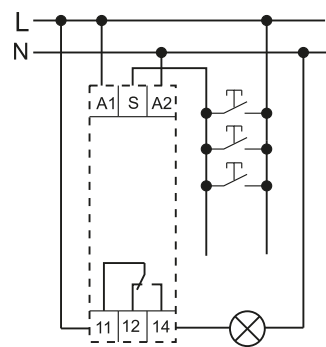

Jelzőcsengők

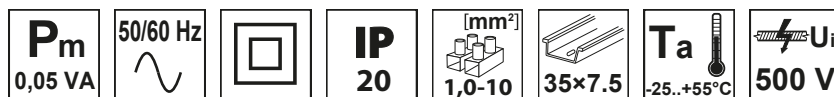

TRACON	U _m		
C60-CSEN	230 V AC	60 dB	max. 60 min.
C60-CSEN-24	24 V AC	60 dB	max. 60 min.
C60-CSEN-12	12 V AC	60 dB	max. 60 min.
C60-CSEN-8	8 V AC	60 dB	max. 60 min.

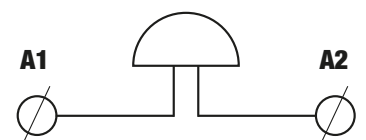
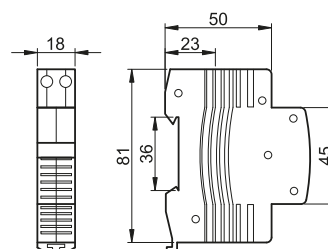

Biztonsági (csengő) transzformátor

IP 20	35x7.5	[mm ²] 0,75-2,5	T_a -25..+55°C	U_i 500 V	V0 UL94	
-----------------	--------	--------------------------------	------------------------------------	-------------------------------	-------------------	--

Piktogramok **F/0**

TRACON	P _s	U _{pr}	U _{sec}	I _{sec}
BT-8/1	max. 8 VA	230 V AC	4, 8, 12 V AC	0,66 A
BT-8/2			8, 12, 24 V AC	0,33 A

Törpefeszítésű, biztonsági elválasztó transzformátor. Érintés-
védelmi célú törpefeszítést szolgáltat; a hagyományos csen-
gő táplásán kívül a teljesítménynek megfelelően más célra is
lehet használni, pl. elektronikus eszközök AC tápfeszültségeként.

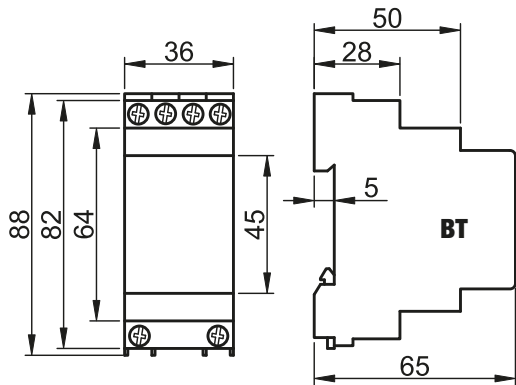

RELEVANT STANDARD
EN 61558-2-8

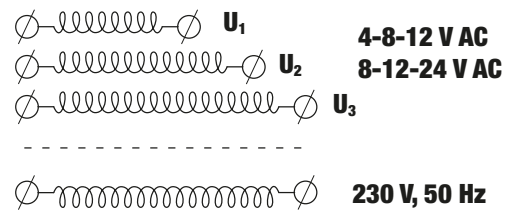

Sorolható csatlakozóaljzat

IP 20	35x7.5	[mm ²] 0,75-2,5	T_a -25..+55°C	U_i 500 V	V0 UL94
-----------------	--------	--------------------------------	------------------------------------	-------------------------------	-------------------

TRACON		I _n (A)	U _n
C60-DA0	2P+	16	250 V AC
C60-DA	2P+	16	250 V AC



C60-DA0

C60-DA

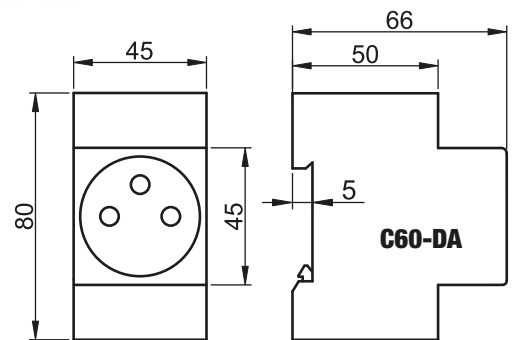
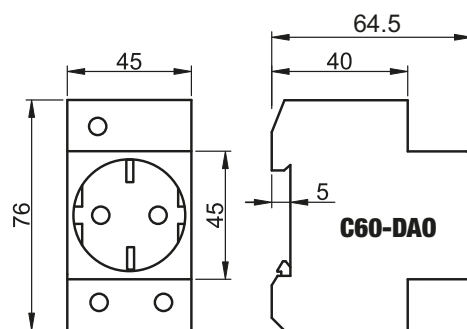

RELEVANT STANDARD
MSZ 9872

RELEVANT STANDARD
IEC 60884-1

























TÜV MEEI TEST DOCUMENTATION
28208191 001

Falon kívüli kapcsolók és csatlakozóaljzatok, TR-PH típus

230 V AC	V1 UL94	IP 54	$[mm^2]$ 1-2,5	Ta -25...+55°C	U_i 500 V
--------------------	-------------------	-----------------	-------------------	--------------------------	----------------

 **Piktogramok** **F/0**



TRACON		 SHUKO	 FRENCH	
TR-PH01		×1	–	–
TR-PH02		×2	–	–
TR-PHF02		–	×2	–
TR-PH03		×1	–	101
TR-PHF03		–	×1	101
TR-PH08		×1	–	106
TR-PHF08		–	×1	106
TR-PH11		×1	–	102
TR-PH03V		×1	–	101
TR-PHF03V		–	×1	101
TR-PH08V		×1	–	106
TR-PHF08V		–	×1	106
TR-PH09V		×1	–	2×101
TR-PHF09V		–	×1	2×101
TR-PH10V		×1	–	2×106
TR-PHF10V		–	×1	2×106
TR-PH09		×1	–	2×101
TR-PHF09		–	×1	2×101
TR-PH10		×1	–	2×101
TR-PHF10		–	×1	2×101
TR-PH04		–	–	102
TR-PH05		–	–	101
TR-PH05L*		–	–	101
TR-PH06		–	–	106
TR-PH06L*		–	–	106
TR-PH07		–	–	N101
TR-PH07L*		–	–	N101
TR-PH05-2		–	–	2×101
TR-PH06-2		–	–	2×106

* jelzőfényvel

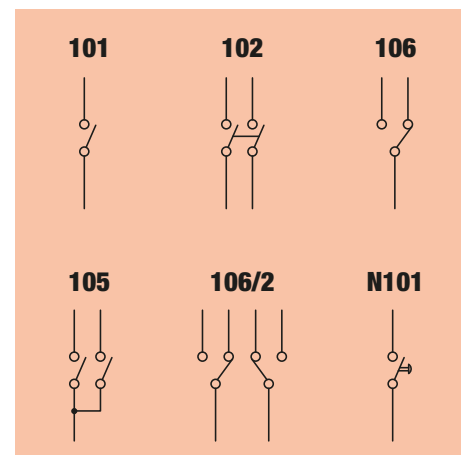
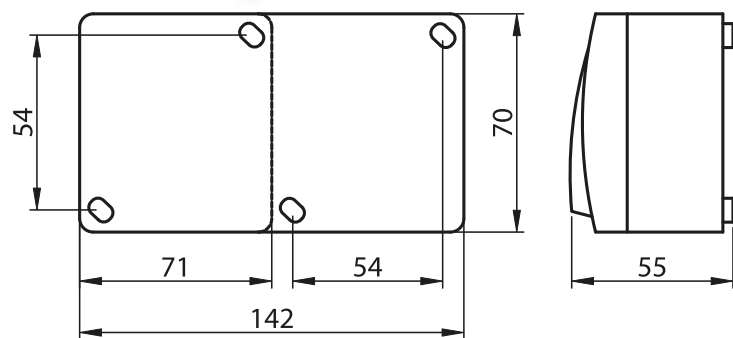

RELEVANT STANDARD
EN 60669-1

TÜV MEEI TEST DOCUMENTATION
28208176 001

Falon kívüli kapcsoló és csatlakozóaljzat, TTK típus

230 V AC	V1 UL94	IP 20	[mm²] 1-2,5	Ta -25..+55°C	U_i 500 V
--------------------	-------------------	-----------------	----------------------------------	-------------------------	-------------------------------

F/O

TRACON

TTK-11	TTK-12	TTK-13*	TTK-21	TTK-31	TTK-32
SCHUKO	FRENCH	NO EARTH*	(RJ11 6/4) Telephone	9,5 mm TV	9,5 mm TV+FM

TRACON

TTK-01	TTK-02	TTK-03	TTK-04B	TTK-04L	TTK-04W	TTK-05	TTK-06	TTK-07
101	106	102	N101	N101	N101	2x101	105	2xN101

* Csak régi szerelésekhez hiánypótlásra alkalmazható!

101 	102 	105 	106 	N101
----------------	----------------	----------------	----------------	-----------------

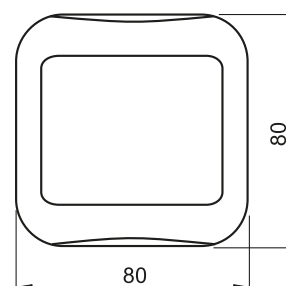

RELEVANT STANDARD
EN 60669-1

RELEVANT STANDARD
IEC 60884-1

RELEVANT STANDARD
MSZ 9871-2

TÜV MEEI TEST DOCUMENTATION
28208176 001

Falon kívüli kapcsoló és csatlakozóaljzat, TFK típus



230 V AC	V1 UL94	IP 20	[mm ²] 1-2,5	T _a -25..+55°C	U _i 500 V	50/60 Hz
-------------	------------	----------	-----------------------------	------------------------------	-------------------------	----------

TRACON

TFK101	TFK101B	TFK102	TFK105	TFK106	TFKSCH	TFKSCH-2	TFKSCH-3
× 1 10 AX/250 V IP 20, (101)	× 1 10 AX/250 V IP 20, (N101)	× 1 10 AX/250 V IP 20, (102)	× 1 10 AX/250 V IP 20, (2×101)	× 1 10 AX/250 V IP 20, (106)	× 1 16 A/250 V, IP 20	× 2 16 A/250 V, IP 20	× 3 16 A/250 V, IP 20



TFK101B



TFK102



TFK105

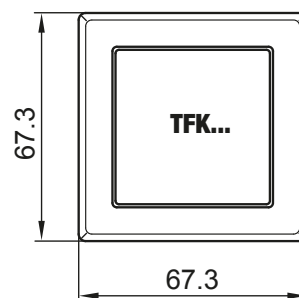

TFKSCH



TFKSCH-2



TFKSCH-3

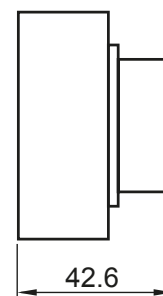
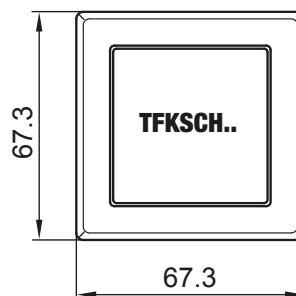

Süllyesztett csatlakozóaljzat USB porttal

230 V AC	V1 UL94	IP 20	[mm ²] 1-2,5	T _a -25..+55°C	U _i 500 V	50/60 Hz
-------------	------------	----------	-----------------------------	------------------------------	-------------------------	----------

TRACON

USB-21



× 1
16 A/250 V,
IP 20

USB: 5V, 2100mA



SCHUKO + USB

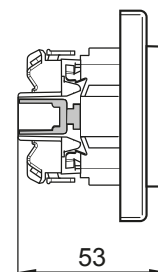
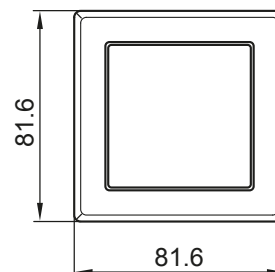

Vezeték nélküli csengő

Ta -20...+45°C

IP 44

Piktogramok **F/0**

TRACON			A ← L → B						
BELLW1-1V1	3×AA	1×CR2032	100 m	82 dB	10	✓	✓	1 db	1 db
BELLW1-1V2	3×AA	1×CR2032	100 m	82 dB	10	✓	✓	1 db	2 db
BELLW1-2V1	3×AA	1×CR2032	100 m	82 dB	10	✓	✓	2 db	1 db
BELLW2-2V1	3×AA	1×CR2032	100 m	82 dB	10	✓	✓	2 db	1 db
BELLW3-1V1	2×AA	1×CR2032	100 m	82 dB	32	-	-	1 db	1 db
BELLW4-1V1	230 V AC	kinetikus	100 m	82 dB	16	✓	✓	1 db	1 db
BELLW5-1V1	230 V AC	kinetikus	100 m	82 dB	16	✓	✓	1 db	1 db



**BELLW1-1V1,
BELLW1-1V2,
BELLW1-2V1**



BELLW3-1V1



BELLW2-2V1



BELLW4-1V1



BELLW5-1V1

Iskolai csengő

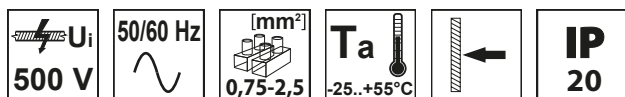

TRACON	U_m	I_n		[h]	H (mm)	W (mm)	D_1 (mm)	D_2 (mm)	d (mm)
BELL8S	8 V AC	0,33 A	65 dB	max. 60 min.	148	72	36	36	76
BELL8	8 V AC	0,55 A	85 dB	max. 60 min.	220	124	47	61	120
BELL24	24 V AC	0,17 A	85 dB	max. 60 min.	220	124	47	61	120
BELL230	230 V AC	0,03 A	85 dB	max. 60 min.	220	124	47	61	120



BELL8,
BELL24,
BELL230

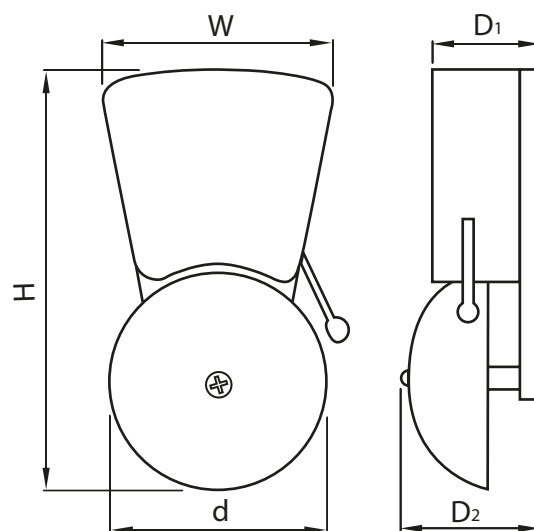

LV

**VÉDETT LED
LÁMPATEST**

**TRACON
ELECTRIC®**

E/58

VF Fürdőszoba ventilátorok



Rácsos előlap (VF)

TRACON			 0,rel.% 40-100	 1s-12min	A (mm)	B (mm)	C (mm)	D (mm)	
VF100-B	✓	—	—	—	161×161	22	55	98	100 mm
VF100-BT	✓	—	—	✓	161×161	22	55	98	100 mm
VF100-BTS	✓	✓	—	✓	161×161	22	55	98	100 mm
VF100-BTSH	✓	✓	✓	✓	161×161	22	55	98	100 mm

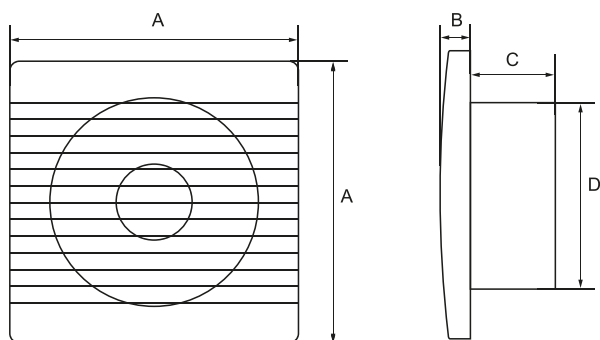

15 W

33 dB

80 m³/h



VF...

Automata zsalu előlap (VFM)

TRACON			 0,rel.% 40-100	 1s-20min	A (mm)	B (mm)	C (mm)	D (mm)	
VFM100-B	✓	—	—	—	150×150	50	42	98	100 mm
VFM100-BT	✓	—	—	✓	150×150	50	42	98	100 mm
VFM100-BTH	✓	—	✓	✓	150×150	50	42	98	100 mm

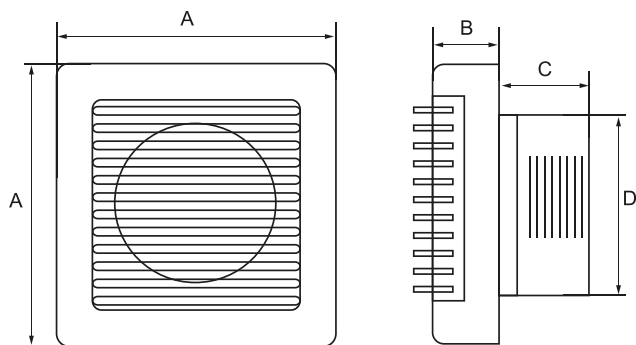

15 W

33 dB

80 m³/h



VFM...

Külső rácsok

TRACON	A (mm)	B (mm)	∅ D (mm)
VFG100	151	45	96
VFS100	151	45	96

VF100-B golyóscsapágy

VF100-BT zsalu

VF100-BTS páratartalom

VF100-BTSH időzítő

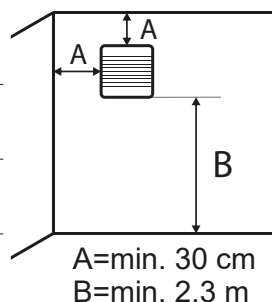

VFG100



VFS100

Szén-monoxid érzékelő

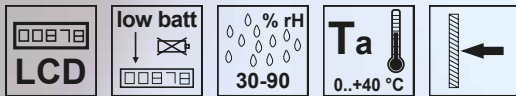

CO gáz koncentráció	30 ppm	50 ppm	100 ppm	300 ppm
EN 50291 szabvány követelménye	Nincs riasztás	60 - 90 perc	10 - 40 perc	<3 perc
Mérési eredmények a TÜV SÜD R-546875 jegyzőkönyve alapján	Nincs riasztás	66 - 71 perc	26 - 33 perc	64 - 85 s
Mérési eredmények a Szenzortechnika Kft. G/265/2015 jegyzőkönyve alapján	Nincs riasztás	71 - 72 perc	20 perc	31 - 50 s

A kompakt méretű érzékelők segítségével a mérgező, színtelen és szagtalan szén-monoxid gáz jelenléte mutatható ki a lakások levegőjében. A szén-monoxid a tökéletlen égés eredményeképpen juthat a meghibásodott fűtőberendezésből a lakásba akár halálos, fulladásos balesetet is okozva. Az érzékelő 4 lépcsőben fény- és hangjelzéssel riaszt, ha a gáz koncentrációja egy beállított értéket átlép, így védve a lakásban tartózkodók egészségét. A készülék azonban nem nyújt védelmet a szén-monoxid krónikus hatásai ellen és nem biztosít teljes védelmet a speciális kockázattal szemben! A termék használata nem helyettesíti a fűtőberendezések szakszerű telepítését és karbantartását, valamint a megfelelő szellőzés biztosítását!

- Tápellátás: 3 db 1,5 V AA elem
- Érzékelő elem: elektrokémiai cellás
- Áramfelvétel: Nyugalmi állapot: <80 µA
Riasztás: 0,4 - 1,5 mA
- A riasztás típusa: fény- és hangjelzés
- Kijelzés (LCD): alaphelyzet: PPM, külső hőmérséklet, elemállapot
riasztás/teszt: ERR – hiba; --- - teszt;
HCO – magas CO érték
END: élettartam vége
- Optikai kijelzés (LED): működés (zöld), hiba (sárga), riasztás (piros)
- Beállási idő: 5 s
- Beépített testgomb

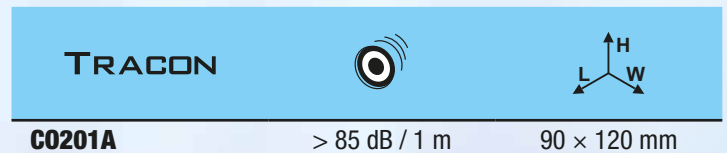

Az érzékelő egység élettartama az első beüzemelésétől számított 7 év. Az érzékelő „élettartam vége” kijelzési opcióval rendelkezik.



Előzze meg a bajt!

Vezeték nélküli füstérzékelő átjelzési lehetőséggel

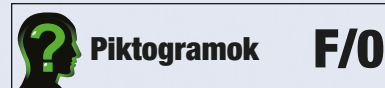
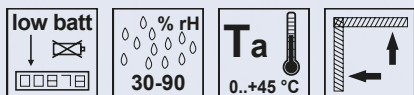

TRACON



Hz



SD101LD > 85 dB / 3 m 433,92 MHz Ø125 × 125 × 48 mm

A kompakt méretű vezeték nélküli érzékelők segítségével a helységben a füst jelenléte mutatható ki, így a tűz elleni személy- és vagyonevédelemben kiválóan alkalmazhatók. A készülék hangjelzéssel riaszt és megfelelő vevő felé távjelzést ad már csekély füst érzékelése esetén is, így a zárt helyiségekben keletkező füst is jelezhető az átjelzési mód használatával.

Tápellátás: 3 db 1,5 V AA elem (adó)
1 db 9 V 6LR61 elem (érzékelő)

A riasztás típusa: fény- és hangjelzés

Áramfelvétel: Nyugalmi állapot (9 V): <12 µA
Riasztás (9 V): <20 mA
Jelzés (4,5 V): <230 µA

Beépített teszt- és tanítógomb



RELEVANT STANDARD
EN 14604:2005



Füstérzékelő átjelzési lehetőség nélkül

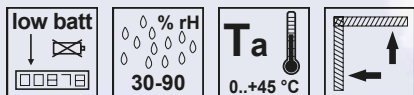

TRACON



SD133A > 85 dB / 3 m 103×103×35 mm

Az egyszerű kivitelű érzékelők működése a vezeték nélküli típuséval azonos, azonban a készülék nem rendelkezik a vezeték nélküli átjelzési funkcióval.

Tápellátás: 1 db 9 V 6LR61 elem (érzékelő)

A riasztás típusa: fény- és hangjelzés

Áramfelvétel: Nyugalmi állapot (9 V): <12 µA
Riasztás (9 V): <20 mA
Jelzés (4,5 V): <230 µA

Beépített teszt- és tanítógomb



RELEVANT STANDARD
EN 14604:2005







**A TERMÉKEK RÉSZLETES ADATLAPJA
MEGTALÁLHATÓ WEBÁRUHÁZUNKBAN!**

Táblázat fejlécek piktogramjai

U_n Névleges feszültség (V)	I_n Névleges áram (A)	 Kapcsolóval	U_p T3 Védelem - túlfeszültség
P_{max} Maximális terhelhetőség	 Kapcsoló nélkül	 Védelem - TV	CEE Beépített csatlakozóvezeték
 Védelem - számítógép	 Védelem - Telefon	 Bemenet	 Csatlakozó lengőaljzat (CEE)
I_{max} > I_n Védelem - túláram	×17.5  Modulok száma	 Ipari csatlakozódugó (CEE)	 Pólusszám
 Kismegszakító	 Áram-védőkapcsoló	 Oldalsó védőérintkezős (SCHUKO)	 Elem típusa, adó
 Euro	 Csapos védőérintkezős (FRENCH)	 Járattartalék	 Elem típusa, vevő
 Méretek (L×W×H)	IP.. Védettségi fokozat	 Kapcsoló	 Frekvencia (Hatótávolság)
 Beköthető vezeték keresztmetszet mm ²			

Műszaki adatok piktogramjai

230/400 V AC Névleges feszültség (V)	I_n max. 16 A Névleges áram (A)	 Járattartalék	 Akkumulátor típusa
 U_i 690 V Névleges szigetelési feszültség	 tip.3 Védelmi fokozat	U_p 1,5 kV Feszültségvédelmi szint	P_m 2,5 VA Saját teljesítményfelvétel
IP 20 Védettségi fokozat	 I. érintésvédelmi osztály	 II. érintésvédelmi osztály	 Szerelősínre szerelhető
 Kábel típusa	3×1 mm² 1,5 m Vezeték méret	 Gyerekvédelmi zár	 Relatív páratartalom
 Elektronikus mérőműszer	 Elektromechanikus mérőműszer	 Villamos élettartam	 Mechanikus élettartam
ABS Anyag: ABS	V0 UL94 Lángállóság UL94 szerint	T_a -25..+55°C Környezeti hőmérséklet	 Beltéri használatra
IK 08 Ütésállóság			

				
Digitális napi kapcsolóóra, moduláris 2	Elektromechanikus kapcsolóóra 2	Dugaszolható kapcsolóórák 3	Csatlakozó aljzat adapter wifi kapcsolóval 5	Távkapcsolós csatlakozóaljzat 5
				
Kábeldobos hosszabbítók 6	UH univerzális hosszabbítók 7	Csatlakozódugó kábel 8	Csatlakozóaljzat adapter 2 db USB porttal, fehér 9	Hordozható elosztósáv kapcsolóval, fehér 9
				
Újravezetékelhető, rögzíthető elosztósávok 10	Többférőhelyes védett elosztósávok 11	Forgatható, elosztósávok kapcsolóval 12	Szerelhető csatlakozódugók és aljzatok 13	Bútor mögé rejthető csatlakozódugók 14
				
Védőérintkezős átalakító csatlakozók 15	Többférőhelyes átalakító csatlakozó 15	Többférőhelyes kombinált átalakító csatlakozók 16	Védőérintkezős hármás, gumi, lengő csatlakozóaljzat 16	Oldalsó védőérintkezős csatlakozódugó és aljzatok 17
				
Védőérintkezős csatlakozódugó és aljzat húzófüllel 17	Ipari csatlakozódugók 18	Fázisfordító ipari csatlakozódugó 19	Csatlakozó lengőaljzatok 20	Felületre szerelhető ipari csatlakozóaljzat retesztel kapcsolóval 21
				
Felületre szerelhető ipari csatlakozódugók 22	Felületre szerelhető ipari csatlakozóaljzatok 23	Beépíthető egyenes ipari csatlakozóaljzat 24	Beépíthető ferde ipari csatlakozóaljzat 24	Beépíthető oldalsó és csapos védőérintkezős csatlakozóaljzat 25
				
Oldalsó védőérintkezős adapterek 25	Ipari csatlakozó elosztók 26	Ipari csatlakozó dobozok 27	Üres ipari csatlakozó dobozok 30	Kiegészítő termékek 31

Digitális napi kapcsolóóra, moduláris



TRACON	t_{batt}	P_{max} 	P_{max} $\cos \varphi = 1$
EVOKOND	150 h	1.000 W	3.600 W

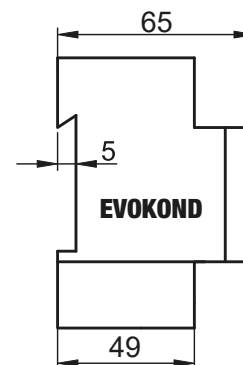
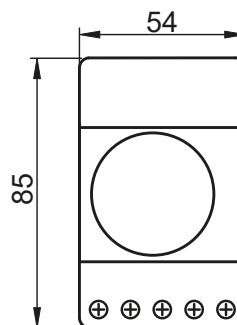
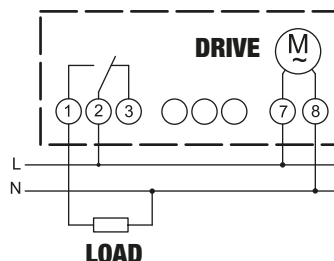

- Időzítési tartomány: 24 óra
- Időzítés léptéke: 15 perc
- Naponta ismétlődő azonos kapcsolásokhoz
- Az időzítőtől független KI-BE kapcsolási lehetőség
- Kézi és automata üzemmód
- Potenciálfüggetlen váltóérintkező
- Ütés- és UV-álló ház

**RELEVANT STANDARD
EN 60730**

Elektromechanikus kapcsolóóra

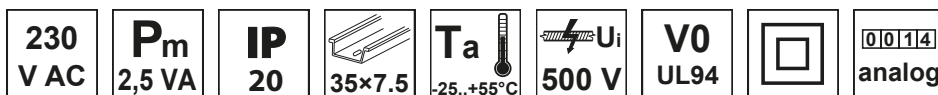

TRACON	t_{batt}	P_{max} 	P_{max} $\cos \varphi = 1$
TKO-N	150 h	1.000 W	3.600 W

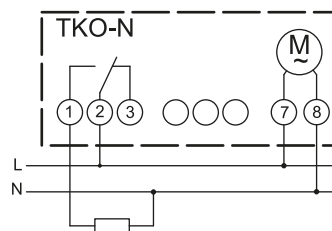

**RELEVANT STANDARD
EN 60730**

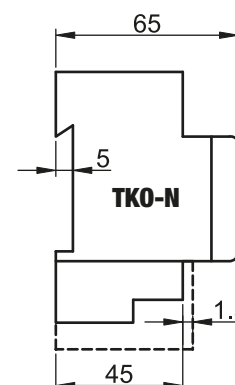
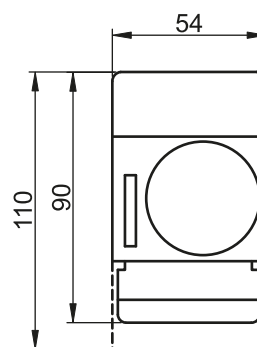

- Időzítési tartomány: 24 óra
- Időzítés léptéke: 30 perc
- Naponta ismétlődő azonos kapcsolásokhoz
- Az időzítőtől független KI-BE kapcsolási lehetőség
- Kézi és automata üzemmód
- Kristályvezérlésű óramű, léptetőmotorral
- Potenciálfüggetlen váltóérintkező
- Ütés- és UV-álló ház

Többfunkciós, heti programozású, elektronikus kapcsolóóra



TRACON	t_{batt}	P_{max}	P_{max} cos $\varphi = 1$
--------	------------	-----------	--------------------------------

TKO-HE 500 h 1.000 W 3.600 W

- Időzítési tartomány: 1 hét
- Időzítés léptéke: 1 perc
- Tárolható programok: 8 db
- Előre beprogramozott kombinációk: 10 db
- 12 vagy 24 órás üzemmód
- Az időzítőtől független KI-BE kapcsolási lehetőség
- Potenciálfüggetlen váltóérintkező

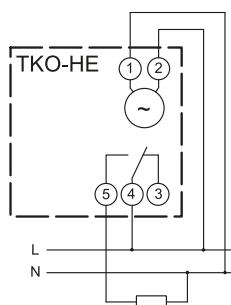
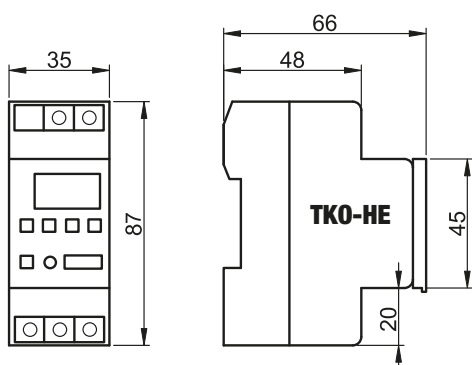

RELEVANT STANDARD
EN 60730

RELEVANT STANDARD
IEC 60884

Dugaszolható elektronikus kapcsolóóra (heti)

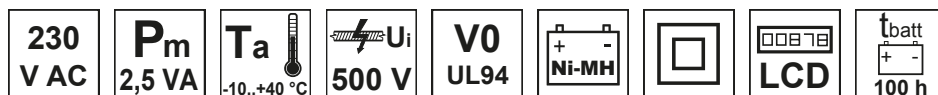

TRACON	P_{max}	P_{max} cos $\varphi = 1$	IP..	
--------	-----------	--------------------------------	------	--

TKO-DHE 1.000 W 3.600 W IP 20 130 × 60 × 43 mm

- Időzítési tartomány: 1 hét
- Időzítés léptéke: 1 perc
- Tárolható programok száma: 20
- Véletlen időzítésű program
- Téli-nyári óráátállítási lehetőség, 12 vagy 24 órás üzemmód
- Az időzítőtől független KI-BE kapcsolási lehetőség
- Gyermekzár a hálózati aljzatban



RELEVANT STANDARD
EN 60730

RELEVANT STANDARD
IEC 60884



Dugaszolható napi kapcsolóóra

230 V AC	P_m 2,5 VA	T_a -10..+40 °C	U_i 500 V	V0 UL94		010114 analog
-------------	--------------------------------	-------------------------------------	-------------------------------	-------------------	--	------------------



TRACON		P_{max} 	P_{max} cos φ = 1	IP..	
TKO-DN		1.000 W	3.600 W	IP 20	120 × 73 × 37 mm
TKO-DNV		1.000 W	3.600 W	IP 44	155 × 73 × 43 mm
TKO-DNF		1.000 W	3.600 W	IP 20	115 × 73 × 37 mm
TKO-DNVF		1.000 W	3.600 W	IP 44	155 × 73 × 43 mm



- Időzítési tartomány: 24 óra
- Időzítés léptéke: 15 perc
- Naponta ismétlődő azonos kapcsolásokhoz
- Az időzítőtől független KI-BE kapcsolási lehetőség
- Gyermekzár a hálózati aljzatban
- Elektromechanikus szerkezet

RELEVANT STANDARD
EN 60730

RELEVANT STANDARD
IEC 60884



Dugaszolható heti kapcsolóóra

230 V AC	P_m 2,5 VA	T_a -10..+40 °C	U_i 500 V	V0 UL94		010114 analog
-------------	--------------------------------	-------------------------------------	-------------------------------	-------------------	--	------------------



TRACON		P_{max} 	P_{max} cos φ = 1	IP..	
TKO-DH		1.000 W	3.600 W	IP 20	115 × 73 × 37 mm



- Időzítési tartomány: 1 hét
- Időzítés léptéke: 105 perc
- Rendszeresen ismétlődő azonos kapcsolásokhoz
- Az időzítőtől független KI-BE kapcsolási lehetőség
- Gyermekzár a hálózati aljzatban
- Elektromechanikus szerkezet

RELEVANT STANDARD
EN 60730

RELEVANT STANDARD
IEC 60884



Csatlakozó aljzat adapter wifis kapcsolóval

230 V AC In max. 16 A Ta -5...+40 °C IP 20

TRACON WIFI SCHUKO P_{max}

WANKU00SW6301 2.4 GHz × 1 max. 3.500 W

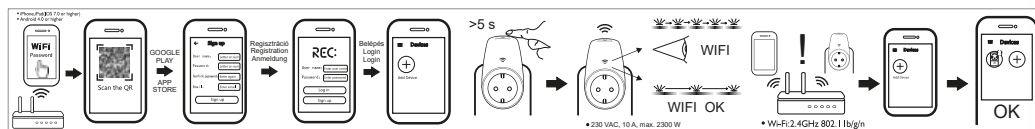

Kapcsoló mögé szerelhető wifi vezérlőegység

230 V AC In max. 10 A Ta -5...+40 °C IP 20

TRACON WIFI P_{max}

WANKU00CSW201 2.4 GHz max. 2300 W

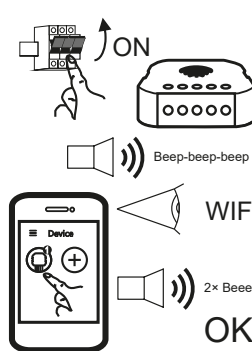
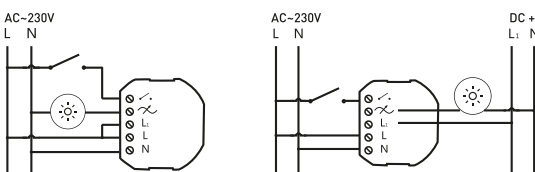

Távkapcsolós csatlakozóaljzat

230 V AC In max. 16 A 50 Hz ×10.000 Ta -20...+40 °C

Piktogramok G/O

TRACON	U _n	P _{max} (AC1)	P _{max} (AC3)	1 × CR2032	433,92 MHz	A ← L → B	IP..	1	1
RCS11	230 V	3600 W	600 W	1 × CR2032	433,92 MHz	30 m	IP 20	1	1
RCS13	230 V	3600 W	600 W	1 × CR2032	433,92 MHz	30 m	IP 20	3	1
RCS11-IP	230 V	3600 W	600 W	1 × CR2032	433,92 MHz	30 m	IP 44	1	1
RCS13-IP	230 V	3600 W	600 W	1 × CR2032	433,92 MHz	30 m	IP 44	3	1



Kábeldobos hosszabbítók

250
V AC

I_n
max.
16 A



Piktogramok

G/O

TRACON			P_{max} 	P_{max} 	 SCHUKO	IP..
KD-4/15-B	15 m	3×1,5 mm ² (H05VV-F)	3.000 W	1.200 W	× 4	IP 20
KD-4/20-B	20 m	3×1,5 mm ² (H05VV-F)	3.000 W	1.200 W	× 4	IP 20
KD-4/25-B	25 m	3×1,5 mm ² (H05VV-F)	3.000 W	1.200 W	× 4	IP 20
KD-4/30-B	30 m	3×1,5 mm ² (H05VV-F)	3.000 W	1.200 W	× 4	IP 20
KD-4/40-B	40 m	3×1,5 mm ² (H05VV-F)	3.000 W	1.200 W	× 4	IP 20
KD-4/50-B	50 m	3×1,5 mm ² (H05VV-F)	3.000 W	1.200 W	× 4	IP 20
KD-6/20-A	20 m	3×1,5 mm ² (H07RN-F)	3.000 W	1.200 W	× 4	IP 44
KD-6/25-R	25 m	3×2,5 mm ² (H07RN-F)	3.000 W	1.200 W	× 4	IP 44
KD-6/40-A	40 m	3×1,5 mm ² (H07RN-F)	3.000 W	1.200 W	× 4	IP 44
KD-9/25-B	25 m	3×1,5 mm ² (H07RN-F)	3.000 W	1.200 W	× 4	IP 44
KD-DOB	max. 50 m*	3×1,5 mm ² (H05VV-F)*	–	–	× 4	IP 20

Műanyag kábeldob, fémvázzal



Fémdobos kábeldob, fémvázzal



Fémdobos üres kábeldob, fémvázzal



Mini műanyag kábeldob, fémvázzal



RELEVANT STANDARD
EN 61242

RELEVANT STANDARD
IEC 60884-1



H07RN-F: sodrott réz erű gumiköpenyes kábel
H05VV-F: sodrott réz erű PVC köpenyes kábel

Kábeldobos hosszabbító, fémvázzal

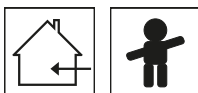
250
V ACIn
max.
16 A

Piktogramok

G/O

TRACON			P_{max} 	P_{max} 	 SCHUKO	IP..
KDZ-4/10	10 m	3×1,5 mm ² (H05VV-F)	3.000 W	1.200 W	× 4	IP 20
KDZ-4/20	20 m	3×1,5 mm ² (H05VV-F)	3.000 W	1.200 W	× 4	IP 20
KDZ-4/30	30 m	3×1,5 mm ² (H05VV-F)	3.000 W	1.200 W	× 4	IP 20
KDZ-4/10G	10 m	3×1,5 mm ² (H07RN-F)	3.000 W	1.200 W	× 4	IP 44
KDZ-4/20G	20 m	3×1,5 mm ² (H07RN-F)	3.000 W	1.200 W	× 4	IP 44
KDZ-4/30G	30 m	3×1,5 mm ² (H07RN-F)	3.000 W	1.200 W	× 4	IP 44
KT-DOB	max. 25 m*	3×1,5 mm ² (H05VV-F)*	–	–	–	–

*Ajánlott hossz, típus, méret

KT-DOB



KDZ-4/10



KDZ-4/10G



KDZ-4/30



KDZ-4/30G



UH univerzális hosszabbítók

250
V ACIn
max.
16 A

Piktogramok

G/O

TRACON			P_{max} 	 SCHUKO
UH10	10 m	H05VV-F	3.680 W	× 1
UH15	15 m	H05VV-F	3.680 W	× 1
UH20	20 m	H05VV-F	3.680 W	× 1
UH20RN	20 m	H07RN-F	3.680 W	× 1
UH25	25 m	H05VV-F	3.680 W	× 1
UH30	30 m	H05VV-F	3.680 W	× 1



TÜV MEEI TEST DOCUMENTATION
28220839 001RELEVANT STANDARD
IEC 60884-1

H07RN-F



H05VV-F

Csatlakozódugó kábel

TRACON	I_n				P_{max}
■ DVK3X0.75	10 A	2 m	H03VV-F	$3 \times 0,75 \text{ mm}^2$	2.300 W
■ DVK3X1.0	16 A	2 m	H05VV-F	$3 \times 1,0 \text{ mm}^2$	3.680 W
■ DVK3X2,5-1,5	16 A	1,5 m	H05VV-F	$3 \times 2,5 \text{ mm}^2$	3.680 W
■ DVK3X2,5-3	16 A	3 m	H05VV-F	$3 \times 2,5 \text{ mm}^2$	3.680 W
■ DVKE2X0.75	2,5 A	2 m	H05VH 2-F	$2 \times 0,75 \text{ mm}^2$	600 W
■ DVKE2X1.0	2,5 A	2 m	H05VH 2-F	$2 \times 1,0 \text{ mm}^2$	600 W



250
V AC



RELEVANT STANDARD
IEC 60884-1

SEMKO TEST CERTIFICATE
1217500



VDE TEST CERTIFICATE
40001514



Hordozható elosztósáv gumikábel

250 V AC I_n max. 16 A  $3 \times 1,5 \text{ mm}^2$ 3-5 m 





 Piktogramok G/O

TRACON			P_{max}	 SCHUKO	IP..
KE3	1,5 m	H07RN-F 3G1.5	max. 3.680 W	3	IP 44
KE4-3M	3 m	H07RN-F 3G1.5	max. 3.680 W	4	IP 44
KE4-5M	5 m	H07RN-F 3G1.5	max. 3.680 W	4	IP 44





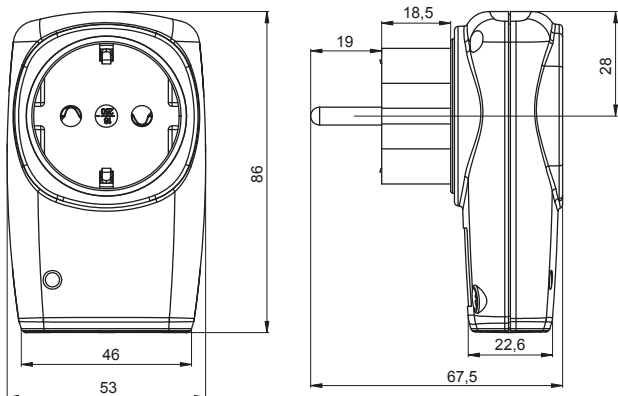

RELEVANT STANDARD
IEC 60884-1

Csatlakozóaljzat adapter 2 db USB porttal, fehér



TRACON	I_n	U_n	 SCHUKO	 USB	 U_n	 I_n
USB	16 A	250 V	×1	×2	5 V	max. 2.1 A



Hordozható elosztósáv kapcsolóval, fehér

Piktogramok G/O

TRACON		P_{max}	 SCHUKO
 HKD-3	1,4 m	max. 3680 W	× 3
HKD-4	1,4 m	max. 3680 W	× 4
HKD-5	1,4 m	max. 3680 W	× 5
HKD-6	1,4 m	max. 3680 W	× 6



Többférőhelyes hordozható elosztósávok oldalsó védőérintkezővel

250
V AC

I_n
max.
16 A



3x1 mm²
1,5 m

3x1,5mm²
3-5 m

RELEVANT STANDARD
IEC 60884-1

RELEVANT STANDARD
IEC 60884-2-7

TRACON				P_{max}	SCHUKO	
1,5 m	3 m	5 m				
	H3	H3-3M	H3-5M	max. 3.680 W	× 3	
	H4	H4-3M	H4-5M	max. 3.680 W	× 4	
	H5	H5-3M	H5-5M	max. 3.680 W	× 5	
	H6	H6-3M	H6-5M	max. 3.680 W	× 6	
		HK3	HK3-3M	HK3-5M	max. 3.680 W	× 3
		HK4	HK4-3M	HK4-5M	max. 3.680 W	× 4
HK5		HK5-3M	HK5-5M	max. 3.680 W	× 5	
HK6		HK6-3M	HK6-5M	max. 3.680 W	× 6	



TÜV MEEI TEST DOCUMENTATION
28208661 002

Többférőhelyes, újrazetetékezhető, rögzíthető elosztósávok

250
V AC

I_n
max.
16 A



Piktogramok

G/O

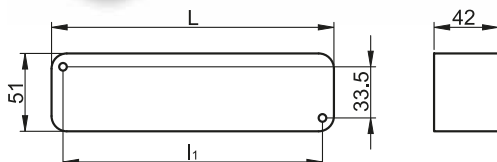

TRACON	SCHUKO	L (mm)	l_1 (mm)
HUR-03	× 3	185	170
HUR-04	× 4	230	215
HUR-05	× 5	270	255
HUR-06	× 6	315	300
HUR-03K	× 3	185	170
HUR-04K	× 4	230	215
HUR-05K	× 5	270	255
HUR-06K	× 6	315	300

RELEVANT STANDARD
IEC 60884-1

TÜV MEEI TEST DOCUMENTATION
28216871 001



Többférőhelyes túlfeszültség ellen védett elosztósávok



TRACON	U_p T3	$I_{max} > I_n$	TV	☎	PC	SCHUKO	FRENCH	0 I	P_{max}
HKTM6-3M-ALU	✓	✓	-	-	-	× 6	-	× 1	max. 3.680 W
HKTM8-3M-ALU	✓	✓	-	-	-	× 8	-	× 1	max. 3.680 W
HKTM6-3M-KT-ALU	✓	✓	✓	✓	-	× 6	-	× 1	max. 3.680 W
HKTM8-3M-KT-ALU	✓	✓	✓	✓	-	× 8	-	× 1	max. 3.680 W
HKTM6-3M-KTS-ALU	✓	✓	✓	✓	✓	× 6	-	× 1	max. 3.680 W
HKTM8-3M-KTS-ALU	✓	✓	✓	✓	✓	× 8	-	× 1	max. 3.680 W
HKT5-3M	✓	-	-	-	-	× 5	-	× 1	max. 3.680 W
HKTM5-3M	✓	✓	-	-	-	× 5	-	× 1	max. 3.680 W
HNKTM8-3M-KT	✓	✓	✓	✓	-	× 8	-	× 1	max. 3.680 W
HNKTM10-3M-KT	✓	✓	✓	✓	-	× 10	-	× 1	max. 3.680 W
HKTMF6-3M-ALU	✓	✓	-	-	-	-	× 6	× 1	max. 3.680 W
HKTMF6-3M-KT-ALU	✓	✓	✓	✓	-	-	× 6	× 1	max. 3.680 W
HKTMF8-3M-KT-ALU	✓	✓	✓	✓	-	-	× 8	× 1	max. 3.680 W
HKTMF6-3M-KTS-ALU	✓	✓	✓	✓	✓	-	× 6	× 1	max. 3.680 W
HKTMF8-3M-KTS-ALU	✓	✓	✓	✓	✓	-	× 8	× 1	max. 3.680 W
HKTF5-3M	✓	-	-	-	-	-	× 5	× 1	max. 3.680 W
HKTMF5-3M	✓	✓	-	-	-	-	× 5	× 1	max. 3.680 W
HNKTMF8-3M-KT	✓	✓	✓	✓	-	-	× 8	× 1	max. 3.680 W

Az elosztósávokban másodlagos villámvédelmi egység van elhelyezve, mely biztosítja az érzékeny elektronikus eszközök védelmét a hálózaton esetleg fellépő túlfeszültségjelenségek ellen. Ajánlott TV, videó, Hifi, számítógép és számos elektromos készülék csatlakoztatására. Az elosztósávok a hátoldalukon található furatokon keresztül falra rögzíthetők.

A túlfeszültségvédelmi egység működőképességét a beépített jelzőlámpa jelzi, ha az nem világít, akkor a védelmi egység működése során a túlfeszültségvédelem megszűnt. Az elosztósáv tovább használható, természetesen túlfeszültségvédelem nélkül.

A túláramvédelmi egység az elosztósáv 16 A névleges áramának megfelelően összesen 22 A-es túláramot enged meg maximum 1 óra időtartamig, majd a betáplálást megszakítja. A túláramvédelmi egységet lehűlés után a nyomógomb működtetésével lehet visszakapcsolni.

Teljes túlfeszültség elleni védelmet csak a három lépcsős (1-2-3 típus), koordináltan kiépített rendszer biztosít!



TÜV MEEI TEST DOCUMENTATION
28218817 001

RELEVANT STANDARD
IEC 60884-1

TÜV MEEI TEST DOCUMENTATION
28208874 002

Forgatható, többférőhelyes túlfeszültség ellen védett elosztósávok



TRACON		P_{max} 				U_p T_3
HRRK3/3	3 m	max. 3.680 W	2 × 3	–	× 2	–
HRRK2/2	3 m	max. 3.680 W	2 × 2	–	× 2	–
HRRK6	3 m	max. 3.680 W	6	–	× 1	–
HRRKT6	3 m	max. 3.680 W	6	–	× 1	✓
HRRKF3/3	3 m	max. 3.680 W	–	2 × 3	× 2	–
HRRKTF3/3	3 m	max. 3.680 W	–	2 × 3	× 2	✓



HRRK2/2



HRRKTF3/3



HRRKT6



RELEVANT STANDARD
IEC 60884-1

TÜV MEEI TEST DOCUMENTATION
2819438 001

Hordozható elosztósáv kapcsolóval fehér, 2×USB port

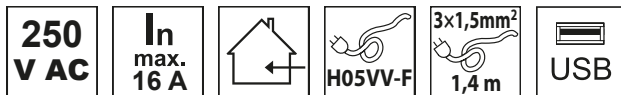

TRACON		P_{max} 		
--------	--	---------------	--	--

HK3-USB 1,4 m max. 3.680 W × 3 2.1 A



RELEVANT STANDARD
IEC 60884-1



OLVASSA BE A KÓDOT!

- Nézze meg újdonságainkat
- Legyen naprakész

Kínálatunk gyorsan és folyamatosan fejlődik!
Katalógusunk a 2021. áprilisi állapotot tükrözi.

Naprakész információért
látogasson el honlapunkra!

Szerelhető csatlakozódugók és aljzatok









**250
V AC**

**In
max.
16 A**



Piktogramok

G/O

TRACON		In	 SCHUKO	 FRENCH	 EURO
TCS D		max. 16 A	✓	-	-
TCS DF		max. 16 A	-	✓	-
TCS DL		max. 10 A	-	-	✓
TCS A		max. 16 A	✓	-	-
TCS AF		max. 16 A	-	✓	-
TCS AL		max. 10 A	-	-	✓
TCS DO		max. 16 A	✓	-	-
TCS DH		max. 16 A	✓	✓	-
TCS DLH		max. 10 A	-	-	✓
TCS AH		max. 16 A	✓	-	-
TCS AH-F		max. 16 A	-	✓	-
TCS ALH		max. 10 A	-	-	✓



EASY PULL

RELEVANT STANDARD
IEC 60884-1

TÜV MEEI TEST DOCUMENTATION
28209308 001

RELEVANT STANDARD
CEE 7

TÜV MEEI TEST DOCUMENTATION
28209309 001

Bútor mögé rejthető csatlakozódugók



250
V AC

In
max.
16 A



Piktogramok

G/O

TRACON



SCHUKO



FRENCH

TCSR



TCSRDB

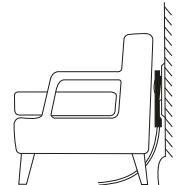

Többférőhelyes védőérintkező nélküli átalakító csatlakozók



250
V AC



Piktogramok

G/O

TRACON

In



EURO

P_{max}

TN2



max. 5 A

× 2

max. 1.150 W

TN3



max. 7,5 A

× 3

max. 1.725 W

TN4



max. 10 A

× 4

max. 2.300 W

TÜV MEEI TEST DOCUMENTATION
28208660 001

RELEVANT STANDARD
IEC 60884-1

RELEVANT STANDARD
IEC 60884-2-5

Csatlakozóaljzat adapter kapcsolóval



250
V AC

In
max.
16 A



Piktogramok

G/O

TRACON



SCHUKO

P_{max}

KACS1

× 1

max. 3.680 W

KACS2

× 2

max. 3.680 W



RELEVANT STANDARD
IEC 60884-1

RELEVANT STANDARD
IEC 60884-2-5

Többférőhelyes védőérintkezős átalakító csatlakozók

250 V AC I_n max. 16 A

Piktogramok **G/O**

TRACON			P_{max}
	SCHUKO	FRENCH	
TDUGO	× 3	–	max. 3.680 W
TDUGO-BARN	× 3	–	max. 3.680 W
TDUGOF	–	× 3	max. 3.680 W
TDUGO9	× 3	–	max. 3.680 W
TDUGO9-BARN	× 3	–	max. 3.680 W

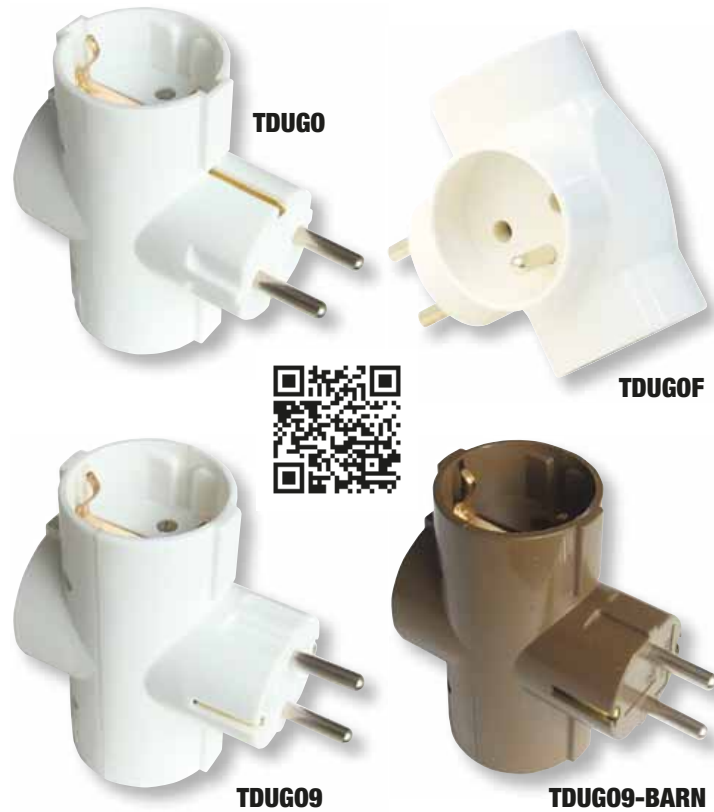

RELEVANT STANDARD
IEC 60884-1

RELEVANT STANDARD
IEC 60884-2-5

RELEVANT STANDARD
MSZ 9871

TÜV MEEI TEST DOCUMENTATION
28208660 001

Többférőhelyes átalakító csatlakozó

250 V AC I_n max. 16 A

Piktogramok **G/O**

TRACON	P_{max}				
		SCHUKO	USB	Un	In
TND2	max. 3680W	× 2	–	–	–
TND2-K	max. 3680W	× 2	–	–	–
TND2-USB	max. 3680W	× 2	× 2	5 V DC	2.1 A
TND3	max. 3680W	× 3	–	–	–





Többférőhelyes kombinált átalakító csatlakozók

250
V AC

I_n
max.
16 A



TRACON	 SCHUKO	 FRENCH	 EURO	P_{max}
TN2/1	× 1	–	× 2	max. 3.680 W
TNF2/1	–	× 1	× 2	max. 3.680 W
TNF2	–	× 2	–	max. 3.680 W
TNS2	× 2	–	–	max. 3.680 W

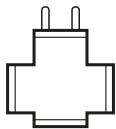

TN2/1



RELEVANT STANDARD
IEC 60884-1

TÜV MEEI TEST DOCUMENTATION
28212737 001

RELEVANT STANDARD
IEC 60884-2-5

RELEVANT STANDARD
MSZ 9871-2







TNS2



TNF2

Védőérintkezős hármás, gumi, lengő csatlakozóaljzat

TRACON	I_n	U_n		 SCHUKO	 FRENCH		D (mm)	L (mm)	IP..
TICS-A4	16 A	250 V	2P + \perp	× 3	–	H07RN-F	115	150	IP 44
TICS-A4F	16 A	250 V	2P + \perp	–	× 3	H07RN-F	95	140	



TICS-A4F



TICS-A4

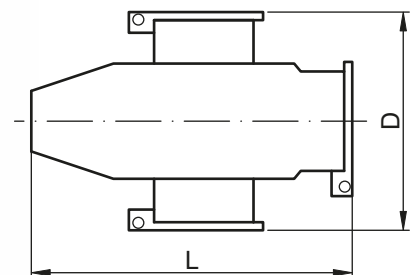

Gumi védőgyűrűvel és védősapkával



OLVASSA BE A KÓDOT!

- Nézze meg újdonságainkat
- Legyen naprakész

Kínálatunk gyorsan és folyamatosan fejlődik!
Katalógusunk a 2021. áprilisi állapotot tükrözi.

Naprakész információért
látogasson el honlapunkra!

Többférőhelyes átalakító csatlakozó, fekete

TRACON	I_n	U_n					IP..
			SCHUKO	FRENCH			
TICS-212GD	16 A	250 V	2P +	x2	-	H07RN-F	IP 44

Oldalsó védőérintkezős csatlakozódugó és aljzatok

TRACON	I_n	U_n					D (mm)	L (mm)	IP..
				SCHUKO	FRENCH				
TICS-012G*	16 A	250 V	2P +	✓	✓	H07RN-F	43	87	
TICS-212G*	16 A	250 V	2P +	✓	-	H07RN-F	51	110	IP 44
TICS-212GF	16 A	250 V	2P +	-	✓	H07RN-F	51	110	

*A G jelű kivitelek összecsatlakoztatott állapotban is megfelelnek az IP 44 jelű védettségi fokozat követelményeinek.

TÜV MEEI TEST DOCUMENTATION
28209307

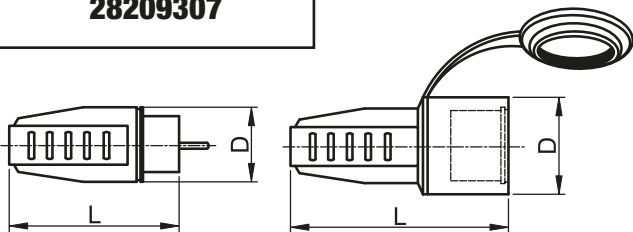

Védőérintkezős csatlakozódugó és aljzat húzófülrel

TRACON	I_n	U_n					D (mm)	L (mm)	IP..
				SCHUKO	FRENCH				
TICS-012GH	16 A	250 V	2P +	✓	✓	H07RN-F	43	115	IP 44
TICS-212GH	16 A	250 V	2P +	✓	-	H07RN-F	51	130	

Összecsatlakoztatott állapotban is megfelelnek az IP 44 jelű védettségi fokozat követelményeinek.

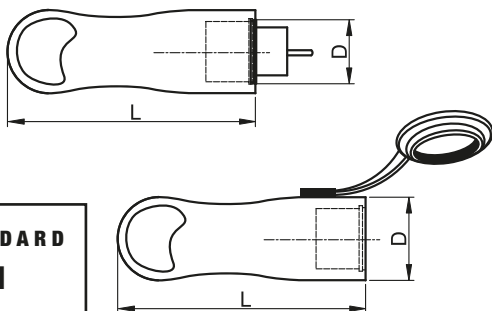

RELEVANT STANDARD
IEC 60884-1



Ipari csatlakozó dugók

TRACON	I _n	U _n		a (mm)	b (mm)	d (mm)		IP..
TICS-013H	16 A	250 V	2P +	128	59	9-17	1,5-2,5	IP 44
TICS-014H		400 V	3P +	133	66	9-17	1,5-2,5	
TICS-015H		400 V	3P + N +	140	81	9-17	1,5-2,5	
TICS-023H	32 A	250 V	2P +	162	81	10-23	4-6	
TICS-024H		400 V	3P +	162	78	10-23	4-6	
TICS-025H		400 V	3P + N +	162	90	10-23	4-6	
TICS-0132H	16 A	250 V	2P +	128	71.5	9-17	1,5-2,5	IP 67
TICS-0142H		400 V	3P +	132.5	79.5	9-17	1,5-2,5	
TICS-0152H		400 V	3P + N +	139.5	87.5	9-17	1,5-2,5	
TICS-0232H	32 A	250 V	2P +	160	93.5	10-23	4-6	
TICS-0242H		400 V	3P +	157	93,5	10-23	4-6	
TICS-0252H		400 V	3P + N +	162	101	10-23	4-6	
TICS-033	63 A	250 V	2P +	215	113	16-32	10-16	IP 67
TICS-034		400 V	3P +	215	113	16-32	10-16	
TICS-035		400 V	3P + N +	215	113	16-32	10-16	
TICS-043	125 A	250 V	2P +	283	133	24-45	25-35	
TICS-044		400 V	3P +	283	133	24-45	25-35	
TICS-045		400 V	3P + N +	283	133	24-45	25-35	

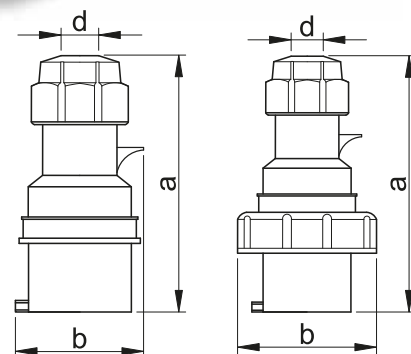

**Csavarhúzó segítségével
egy mozdulattal szétszedhető**







**Megerősített
tömítőgumi és
szorítóanya**

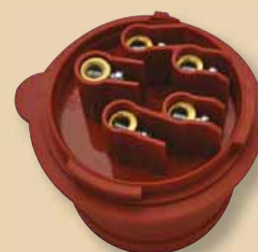

**Pontos
megmunkálás
gyors
szerelhetőség**



Fázisfordítós ipari csatlakozó dugók külső tömítőszelencével

TRACON	I_n	U_n		a (mm)	b (mm)	d (mm)	IP..
TICS-015PF	16 A	400 V	3P + N + 	147	73	7-17	IP 44
TICS-025PF	32 A	400 V	3P + N + 	175	87	9-28	
TICS-0152PF	16 A	400 V	3P + N + 	138	88	7-17	IP 67
TICS-0252PF	32 A	400 V	3P + N + 	163	101	9-21	

A fázisfordítós ipari csatlakozók két fázisvezető érintkező csapja csavarhúzó segítségével egy mozdulattal felcserélhető, ezáltal a működtetni szándékozott motor forgásiránya megváltoztatható.



RELEVANT STANDARD
EN 60309-1
EN 60309-2

Két fázisvezető érintkező csapja csavarhúzó segítségével egy mozdulattal felcserélhető, ezáltal a működtetni szándékozott motor forgásiránya megváltoztatható.

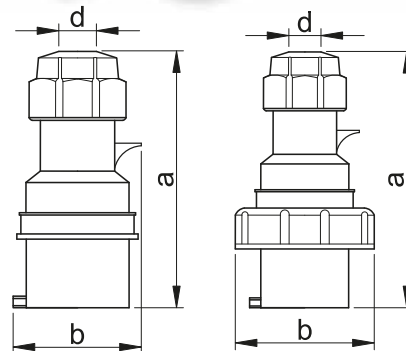

Vízálló takarósapka csatlakozó dugóhoz

TRACON		d_1 (mm)	d_2 (mm)	D (mm)	h (mm)	IP..
TICSCAP163	TICS-0132H.. (16A,3P)	44,5	49	60	41	IP 67
TICSCAP164	TICS-0142H.. (16A,4P)	51	55,5	68	41	IP 67
TICSCAP165	TICS-0152H.. (16A,5P)	57,5	62	76	41	IP 67
TICSCAP3234	TICS-0232H.., TICS-0242H.. (32A,3P/4P)	59	64	82	50	IP 67
TICSCAP325	TICS-0252H.. (32A,5P)	65	70	89	50	IP 67
TICSCAP63345	TICS-033.., -034.., -035.., (63A,3P/4P/5P)	71,5	77	96	72	IP 67
TICSCAP125345	TICS-043.., -044.., -045.., (63A,3P/4P/5P)	84	89,5	109	88	IP 67

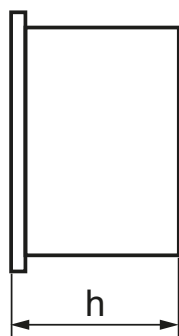
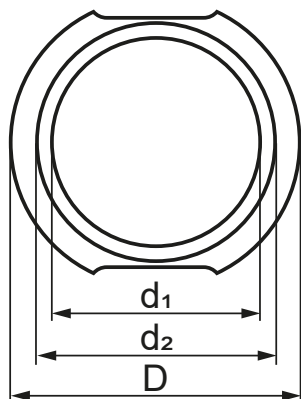

Ipari csatlakozóaljzatok

TRACON	I _n	U _n		a (mm)	b (mm)	d (mm)		IP..
TICS-213H	16 A	250 V	2P +	136	72	9-17	1,5-2,5	IP 44
TICS-214H		400 V	3P +	143	77	9-17	1,5-2,5	
TICS-215H		400 V	3P + N +	150	82,5	9-17	1,5-2,5	
TICS-223H	32 A	250 V	2P +	171	88,6	15-23	4-6	
TICS-224H		400 V	3P +	171	88,6	15-23	4-6	
TICS-225H		400 V	3P + N +	176	100,2	15-23	4-6	
TICS-2132H	16 A	250 V	2P +	139	72	9-17	1,5-2,5	IP 67
TICS-2142H		400 V	3P +	145	77	9-17	1,5-2,5	
TICS-2152H		400 V	3P + N +	152	84	9-17	1,5-2,5	
TICS-2232H	32 A	250 V	2P +	173	87,5	15-23	4-6	
TICS-2242H		400 V	3P +	173	87,5	15-23	4-6	
TICS-2252H		400 V	3P + N +	179	99	15-23	4-6	
TICS-233	63 A	250 V	2P +	236,1	102,4	28-32	10-16	IP 67
TICS-234		400 V	3P +	236,1	102,4	28-32	10-16	
TICS-235		400 V	3P + N +	236,1	108	28-32	10-16	
TICS-243	125 A	250 V	2P +	302,3	114,2	24-48	25-35	
TICS-244		400 V	3P +	302,3	114,2	36-45	25-35	
TICS-245		400 V	3P + N +	302,3	114,2	36-45	25-35	

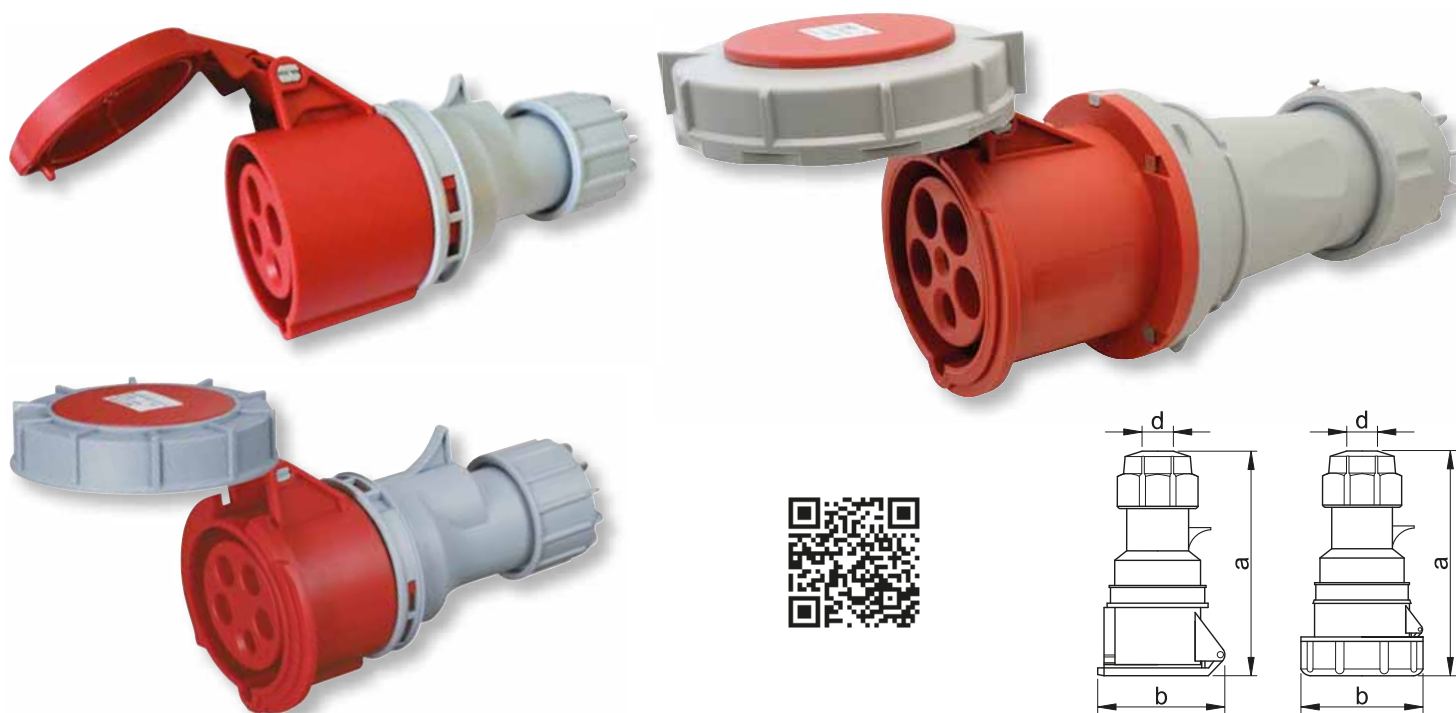

**Csavarhúzó segítségével
egy mozdulattal szétszedhető**



**Megerősített
tömítőgumi és
szorítóanya**



**Pontos
megmunkálás
gyors
szerelhetőség**



Szerkezeti felépítés

A készülékek szerkezeti kivitelezése (a csatlakozódugó vezetőcsapja és a csatlakozóaljzat vezetőhornya ill. vezetőhorony helyzete és mérete) biztosítja a helyes csatlakoztatást, így nem cserélhetők össze a különböző feszültségszintek. Az érintkezőcsapok elrendezése normál (6h). Az IP 67-es védettségű fokozatú csatlakozó magas por és víz elleni védelemmel bír. A zárófedél elfordításával olyan tömítettség áll fenn, amely megfelelően biztosítja az IP 67 jelű védettségű fokozatot.



RELEVANT STANDARD
EN 60309-1
EN 60309-2

RELEVANT STANDARD
EN 60529

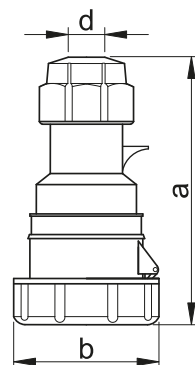
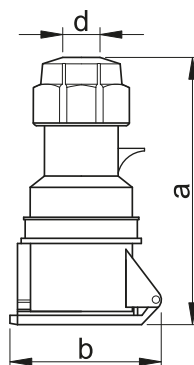

Felületre szerelhető ipari csatlakozóaljzat reteszelt kapcsolóval

TRACON	I_n	U_n		a (mm)	b (mm)	c (mm)	d (mm)	e (mm)	f (mm)	g (mm)	h (mm)	IP..
TICS-1132R	16 A	250 V	2P + ⊥	225	118	144	208	101	6.3	8	252	IP 67
TICS-1152R		400 V	3P + N + ⊥	225	118	147	208	101	6.3	8	259	
TICS-1252R	32 A	400 V	3P + N + ⊥	225	118	153	208	101	6.3	8	274	

A csatlakozódugót biztonságosan (feszültségmentes állapotban) tudjuk az aljzathoz csatlakoztatni kedvezőtlen környezeti feltételek esetén is. A kapcsoló csak bedugott ipari csatlakozódugó esetén kapcsolható be. Az ipari csatlakozódugó csak a kapcsoló kikapcsolt állapotában húzható ki.

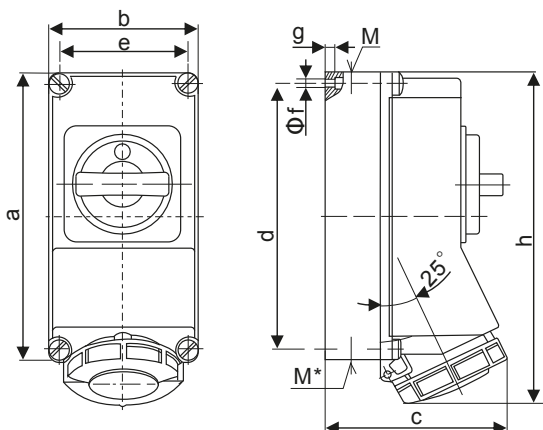

RELEVANT STANDARD
EN 60309-1

RELEVANT STANDARD
EN 60309-1



OLVASSA BE A KÓDOT!

- Nézze meg újdonságainkat
- Legyen naprakész

Kínálatunk gyorsan és folyamatosan fejlődik!
Katalógusunk a 2021. áprilisi állapotot tükrözi.
Naprakész információért
látogasson el honlapunkra!

Felületre szerelhető ipari csatlakozó dugók

TRACON	I _n	U _n		a (mm)	b (mm)	c (mm)	d (mm)	f (mm)	 mm ²	IP..
TICS-513	16 A	250 V	2P + ⊕	134	–	65	117	43	1,5-2,5	IP 44
TICS-514		400 V	3P + ⊕	134	–	69	117	49	1,5-2,5	
TICS-515		400 V	3P + N + ⊕	134	–	74	117	56	1,5-2,5	
TICS-523	32 A	250 V	2P + ⊕	142	–	74	126	63	4-6	
TICS-524		400 V	3P + ⊕	142	–	74	126	63	4-6	
TICS-525		400 V	3P + N + ⊕	142	–	78	126	63	4-6	
TICS-533	63 A	250 V	2P + ⊕	226,3	108,8	112,9	208,5	69,1	10-16	IP 67
TICS-534		400 V	3P + ⊕	226,3	108,8	112,9	208,5	69,1	10-16	
TICS-535		400 V	3P + N + ⊕	226,3	108,8	112,9	208,5	69,1	10-16	
TICS-543	125 A	250 V	2P + ⊕	264,7	138,8	132,8	242,6	81,1	25-35	
TICS-544		400 V	3P + ⊕	226,3	138,8	132,8	242,6	81,1	25-35	
TICS-545		400 V	3P + N + ⊕	226,3	138,8	132,8	242,6	81,1	25-35	

A táblázat a 63 A és 125 A új típus méreteket tartalmazza.

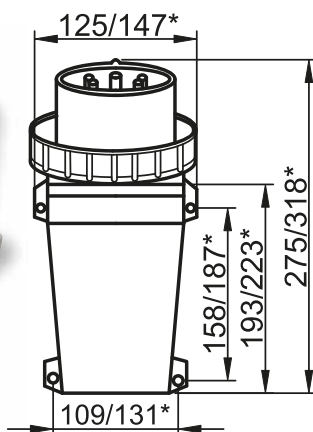
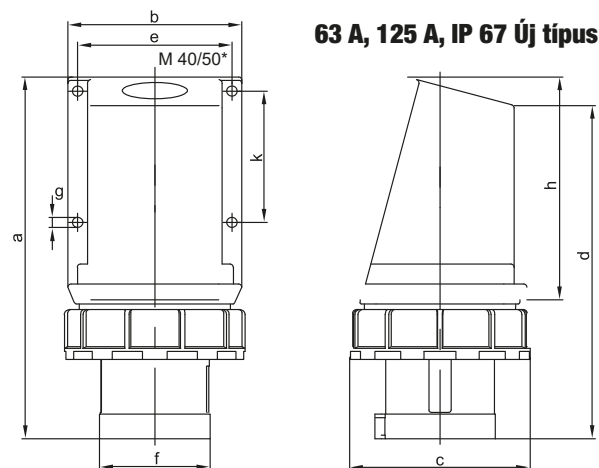
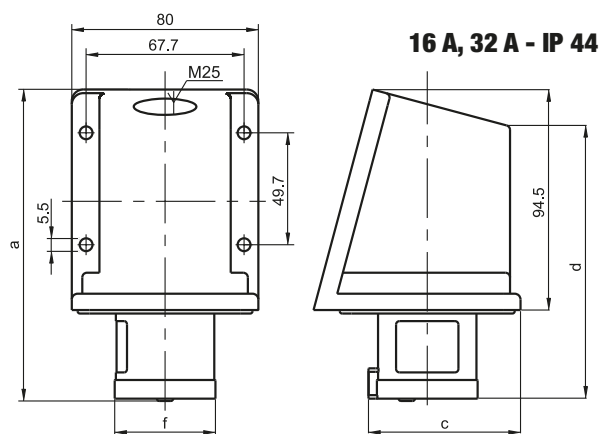

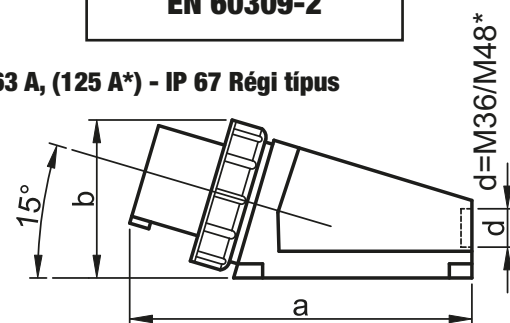

RELEVANT STANDARD
EN 60309-1
EN 60309-2

63 A, (125 A*) - IP 67 Régi típus



Felületre szerelhető ipari csatlakozóaljzatok

TRACON	I _n	U _n		a (mm)	c (mm)	d (mm)	f (mm)	 mm ²	IP..
TICS-113	16 A	250 V	2P + ⊕	141	94	126	50	1,5-2,5	IP 44
TICS-114		400 V	3P + ⊕	141	94	126	63	1,5-2,5	
TICS-115		400 V	3P + N + ⊕	141	94	126	63	1,5-2,5	
TICS-123	32 A	250 V	2P + ⊕	152	99	137	65	4-6	
TICS-124		400 V	3P + ⊕	152	99	137	65	4-6	
TICS-125		400 V	3P + N + ⊕	157	107	142	72	4-6	
TICS-1132	16 A	250 V	2P + ⊕	144	92	129	72	1,5-2,5	IP 67
TICS-1142		400 V	3P + ⊕	144	94	129	79	1,5-2,5	
TICS-1152		400 V	3P + N + ⊕	144	95	129	88	1,5-2,5	
TICS-1232	32 A	250 V	2P + ⊕	154	99	138	93	4-6	
TICS-1242		400 V	3P + ⊕	154	99	138	93	4-6	
TICS-1252		400 V	3P + N + ⊕	160	107	144	101	4-6	
TICS-133	63 A	250 V	2P + ⊕	247	115,7	229,1	117	10-16	IP 67
TICS-134		400 V	3P + ⊕	247	115,7	229,1	117	10-16	
TICS-135		400 V	3P + N + ⊕	247	115,7	229,1	117	10-16	
TICS-143	125 A	250 V	2P + ⊕	284,5	134,6	262,2	129,7	25-35	
TICS-144		400 V	3P + ⊕	284,5	134,6	262,2	129,7	25-35	
TICS-145		400 V	3P + N + ⊕	284,5	134,6	262,2	129,7	25-35	

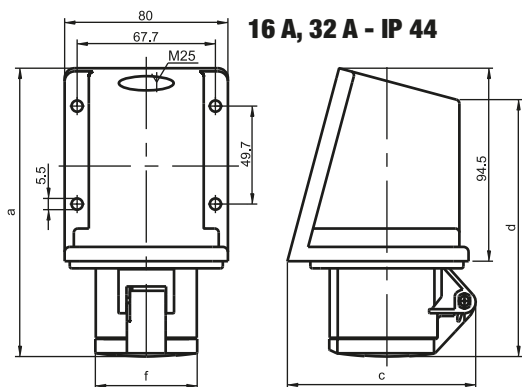

16 A, 32 A - IP 44

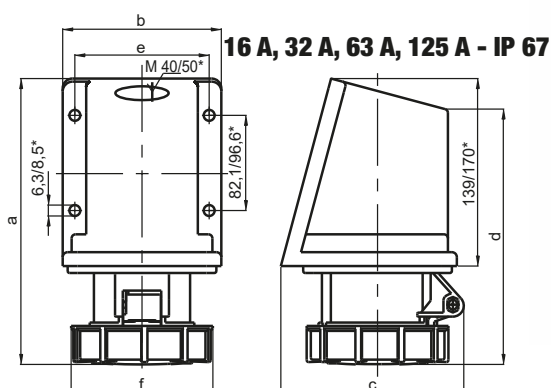

16 A, 32 A, 63 A, 125 A - IP 67



RELEVANT STANDARD
EN 60309

Beépíthető egyenes ipari csatlakozóaljzat

TRACON	I _n	U _n		c (mm)	h (mm)	k (mm)	i (mm)		IP..
TICS-413	16 A	250 V	2P +	43	81	23	44	1,5-2,5	IP 44
TICS-414		400 V	3P +	45	83	23	50	1,5-2,5	
TICS-415		400 V	3P + N +	51	84	25	57	1,5-2,5	
TICS-423	32 A	250 V	2P +	62	89	30	58	4-6	
TICS-424		400 V	3P +	62	89	25	58	4-6	
TICS-425		400 V	3P + N +	67	102	25	63	4-6	

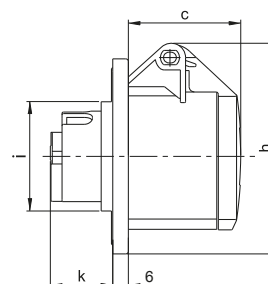
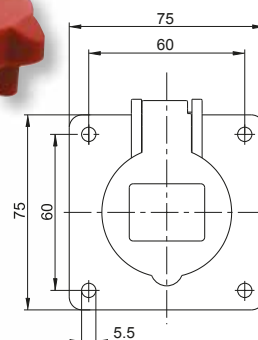

**RELEVANT STANDARD
EN 60309-1**

**RELEVANT STANDARD
EN 60309-2**

Beépíthető döntött ipari csatlakozóaljzat



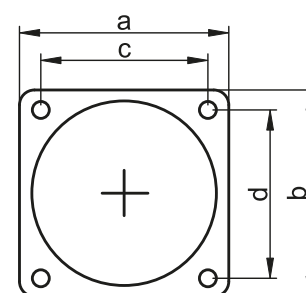
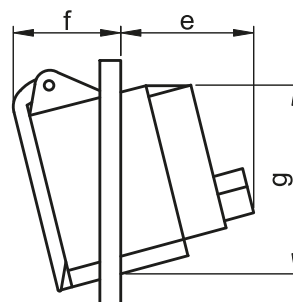



TRACON	I _n	U _n		a (mm)	b (mm)	c (mm)	d (mm)	e (mm)	f (mm)	g (mm)	IP..
TICS-313	16 A	250 V	2P +	62	68	48	48	32	37	60	IP 44
TICS-314		400 V	3P +	76	86	60	60	32	40	65	
TICS-315		400 V	3P + N +	76	86	60	60	36	44	73	
TICS-323	32 A	250 V	2P +	80	96	60	74	42	48	82	
TICS-324		400 V	3P +	80	96	60	74	42	49	78	
TICS-325		400 V	3P + N +	80	96	60	74	42	50	84	



**RELEVANT STANDARD
EN 60309-1**

**RELEVANT STANDARD
EN 60309-2**

Beépíthető oldalsó és csapos védőérintkezős csatlakozóaljzat

TRACON	I_n	U_n				a (mm)	b (mm)	c (mm)	d (mm)	e (mm)	f (mm)	g (mm)	IP..
				SCHUKO	FRENCH								
TICS-105S	16 A	250 V	2P + 	× 1	–	50	61	38	24	23	25	44	IP 44
TICS-105SF	16 A	250 V	2P + 	–	× 1	50	58	38	24	11	32	44	IP 44
TICS-105S67	16A	250V	2P+ 	×1	-	75	83	60	35	37	23	44	IP 67

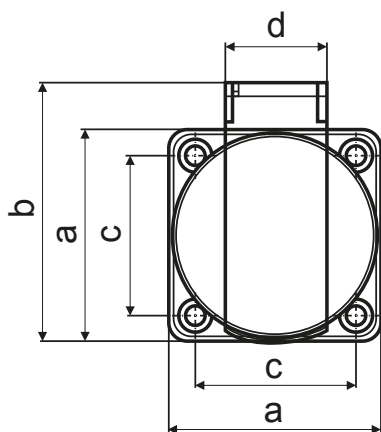
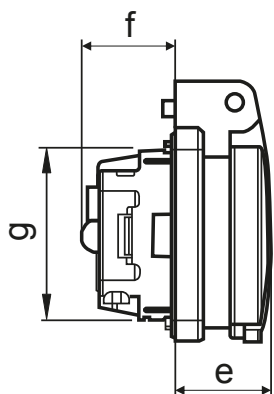

TICS-105S67

TICS-105SF







TICS-105S

RELEVANT STANDARD
IEC 60884-1

RELEVANT STANDARD
MSZ 9871-2

Oldalsó védőérintkezős adapterek

TRACON	I_n	U_n	IN		OUT		D (mm)	L (mm)
								
			SCHUKO	CEE	SCHUKO	CEE		
TICS-A1	16 A	250 V	–	× 1	× 1	–	50	110
TICS-A3	16 A	250 V	× 1	–	–	× 1	73	84

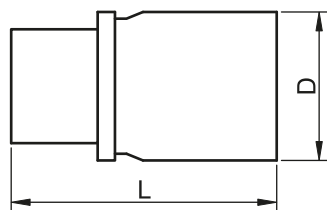
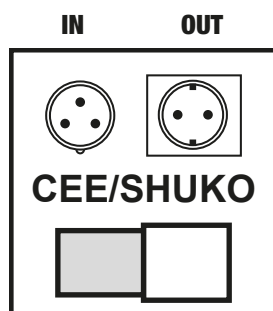

TICS-A1

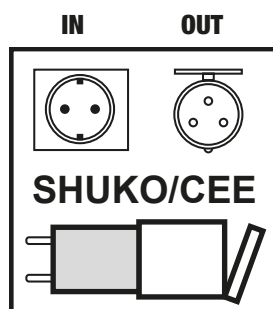



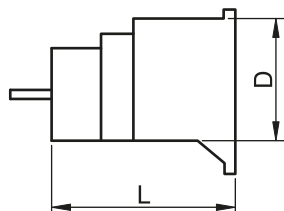



 Piktogramok G/O

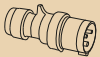

TICS-A3



Ipari csatlakozó elosztók

TRACON	I _n	U _n	IN			OUT			
									
TICS-1023	16 A	250 V	× 1	–	–	× 3	–	–	–
TICS-1024	16 A	400 V	–	× 1	–	–	× 3	–	–
TICS-1025	16 A	400 V	–	–	× 1	–	–	× 3	–
TICS-1605	16 A	400 V	–	–	× 1	–	–	× 1	× 3



TICS-1023

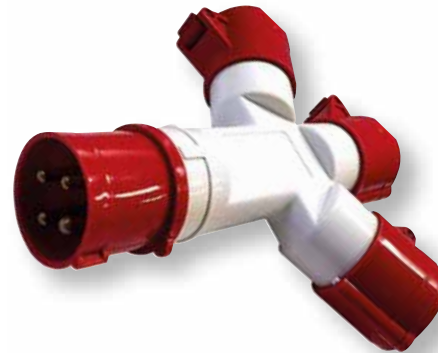
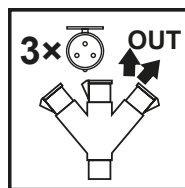
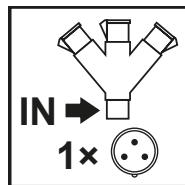

TICS-1024

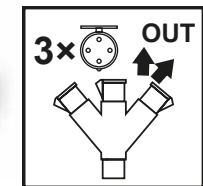
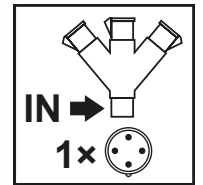

TICS-1025

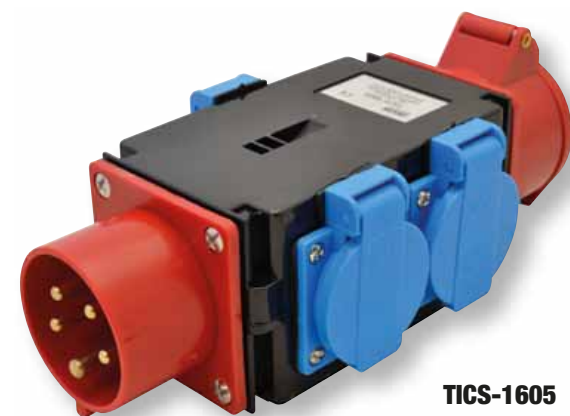
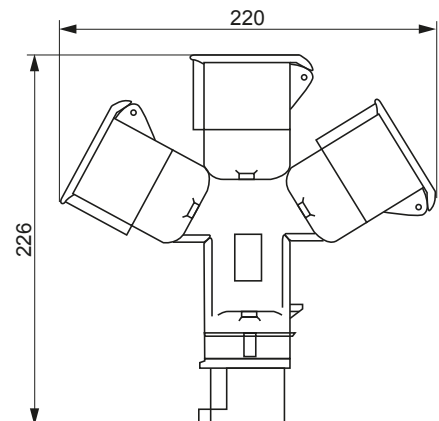
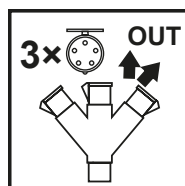
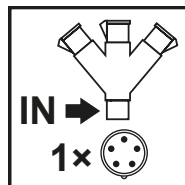

TICS-1605

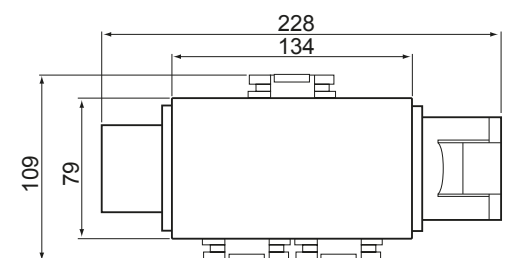
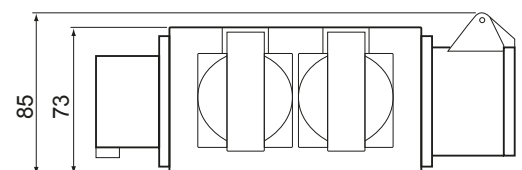
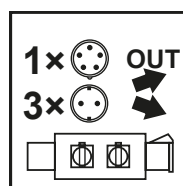
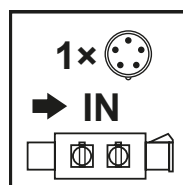

RELEVANT STANDARD
EN 60309-1

RELEVANT STANDARD
EN 60309-2

Ipari csatlakozó dobozok

230/400 V AC	U _i 690 V	ABS	V2 UL94	T _a -25...+55°C	IK10	IP 44
-----------------	-------------------------	-----	------------	-------------------------------	------	----------



TRACON	I _n	U _n	MCB	RCCB	3P + N + \perp	SCHUKO
TDB01-6M	16 A	400 V	-	-	1×(16A/400V)	2×(16/230V)
TDB01-6MV	16 A	400 V	1×(16A,3P,"C",400V~) 2×(16A,1P,"C",230V~)	-	1×(16A/400V)	2×(16/230V)
TDB02-6M	16 A	250 V	-	-	-	2×(16A/250V)
TDB02-6MV*	16 A	250 V	-	1×(16A,1P,"C",0.03A,230V~)*	-	2×(16A/250V)
TDB03-12M	32 A	400 V	-	-	2×(16A/400V) 1×(32A/400V)	4×(16/250V)
TDB03-12MV	32 A	400 V	1×(32A,3P,"C",400V~) 1×(16A,3P,"C",400V~) 2×(16A,1P,"C",230V~)	1×(63A,4P,0.03A,400V~)	2×(16A/400V) 1×(32A/400V)	4×(16/250V)
TDB04-11M	16 A	400 V	-	-	1×(16A/400V)	2×(16A/250V)
TDB04-11MV	16 A	400 V	1×(16A,3P,"C",400V~) 2×(16A,1P,"C",230V~)	1×(25A,4P,0.03A,400V~)	1×(16A/400V)	2×(16A/250V)

* A termék kismegszakítóval kombinált áram-védőkapcsolóval lett ellátva. A csatlakozó dobozok TRACON készülékeket tartalmaznak.

TDB01...

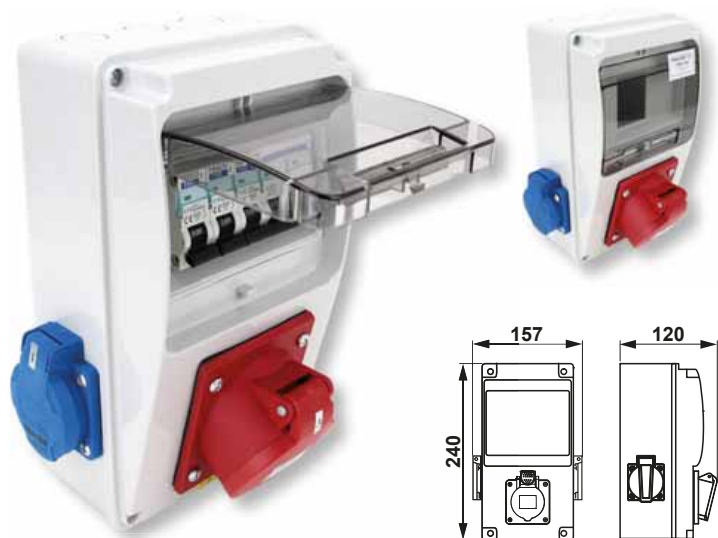

TDB02...

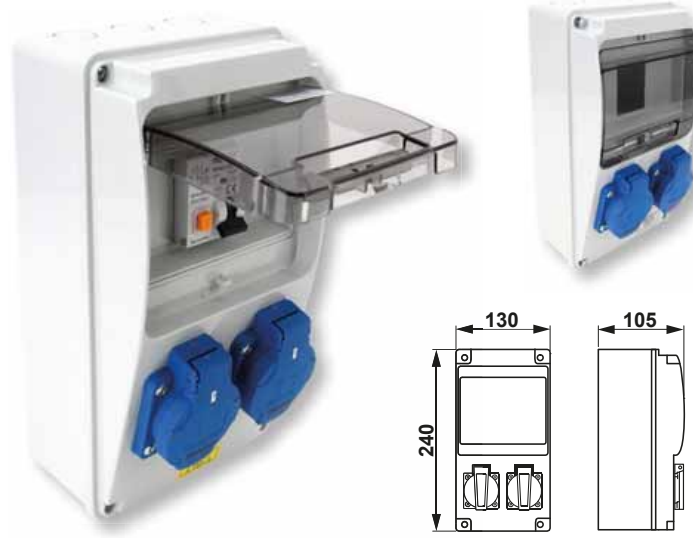

TDB03...

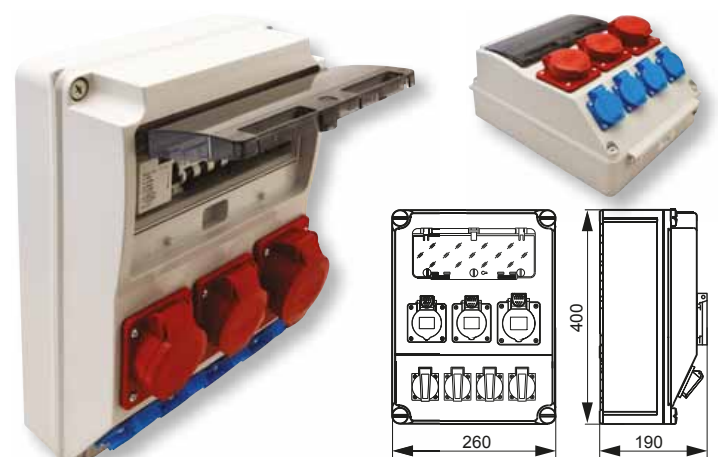

TDB04...

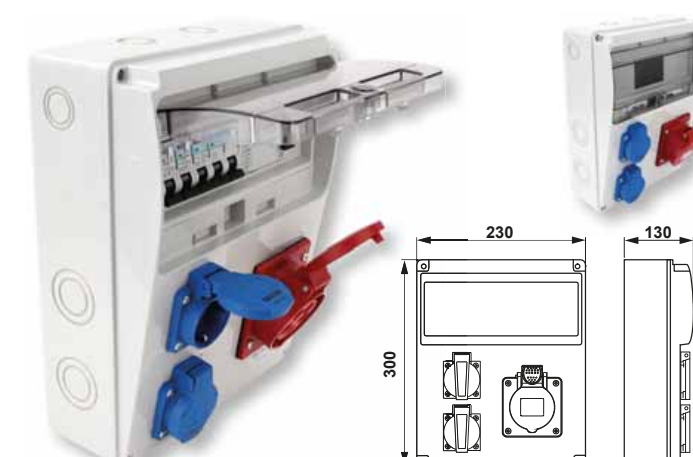

Ipari csatlakozó dobozok

230/400 V AC	U _i 690 V	ABS	V2 UL94	T _a -25...+55°C	IK08	IP 44
-----------------	-------------------------	-----	------------	-------------------------------	------	----------

Piktogramok G/O



TRACON	I _n	U _n	MCB	RCCB	3P + N + PE	SCHUKO
TDB05-6M	16 A	250 V	-	-	-	6×(16A/250V)
TDB05-6MV	16 A	250 V	3× (16A,1P,"C",230V~)	1× (25A,2P,0.03A,230V~)	-	6×(16A/250V)
TDB06-0M	16 A	400 V	-	-	1× (16A/400V)	1×(16A/250V)
TDB07-0M	16 A	250 V	-	-	-	2×(16A/250V)
TDB08-0M	32 A	400 V	-	-	1× (16A/400V) 1× (32A/400V)	4×(16A/250V)

A csatlakozó dobozok TRACON készülékeket tartalmaznak.

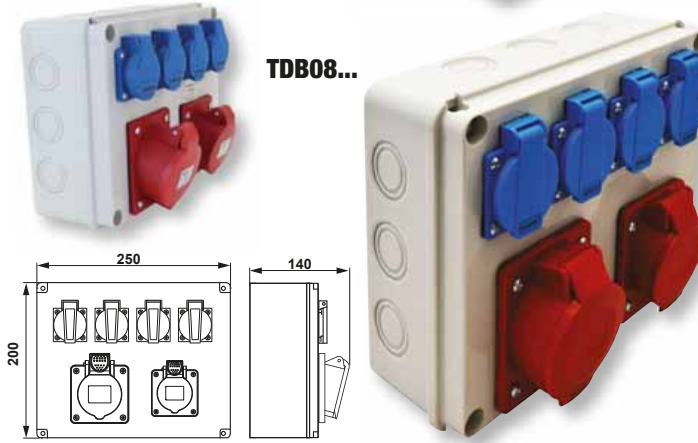
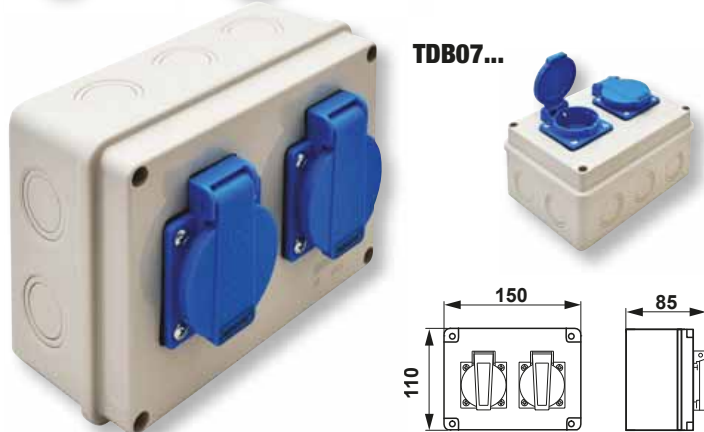
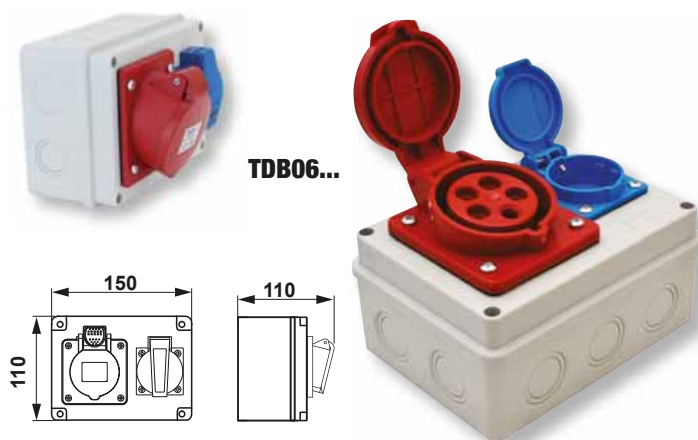
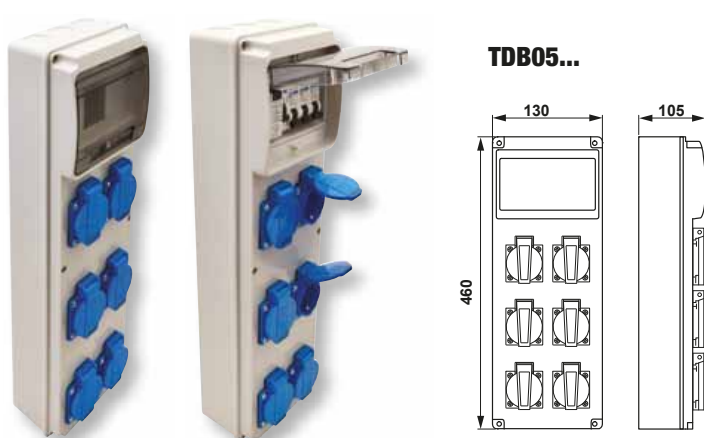

TDB-ALLV

Állvány, ipari csatlakozó dobozhoz



TDB-CABLE...

Csatlakozó kábelek (H07RN-F)



RELEVANT STANDARD
EN 60309-1
EN 60309-2

TRACON	I _n	U _n	L	
TDB-CABLE3P16	16 A	250 V	5 m	3 × G2,5 mm ²
TDB-CABLE5P16	16 A	400 V	5 m	5 × G2,5 mm ²
TDB-CABLE5P32	32 A	400 V	5 m	5 × G4 mm ²

Ipari csatlakozó dobozok

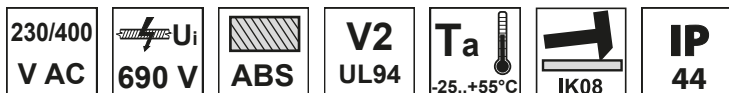

TRACON	I_n	U_n	MCB	RCCB	3P + N + PE	SCHUKO
TDB09-12M	32 A	400 V	–	–	2×32A/400V)	2×(16A/250V)
TDB09-12MV	32 A	400 V	2×(32A,3P,"C",400V~) 2×(16A,1P,"C",230V~)	1×63A, 4P,0.03A,400V~)	2×32A/400V)	2×(16A/250V)
TDB10-11M	32 A	400 V	–	–	1×32A/400V)	2×(16A/250V)
TDB10-11MV	32 A	400 V	1×(32A,3P,"C",400V~) 2×(16A,1P,"C",230V~)	1×40A, 4P,0.03A,400V~)	1×32A/400V)	2×(16A/250V)
TDB11-0M	32 A	400 V	–	–	1×32A/400V)	1×(16A/250V)
TDB12-12MV	32 A	400 V	1×(32A,3P,"C",400V~) 1×(16A,3P,"C",400V~) 2×(16A,1P,"C",230V~)	1× (40A,4P,0.03A,400V~)	1×(32A/400V) 1×(16A/400V)	2×(16A/250V)

A csatlakozó dobozok TRACON készüléket tartalmaznak.

TDB09-12M

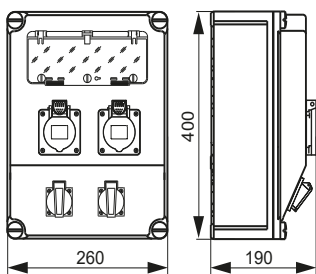

TDB10-11MV

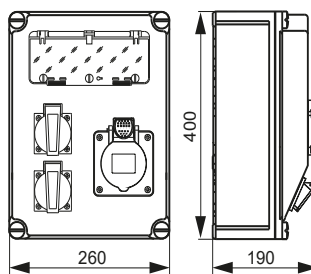

TDB09-12MV

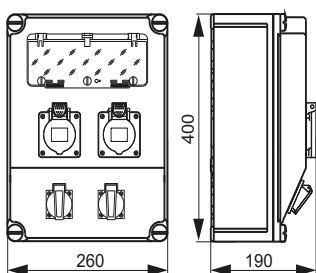

TDB11-0M

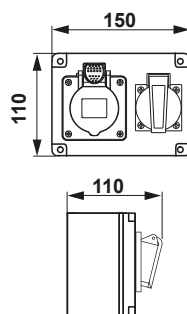

TDB10-11M

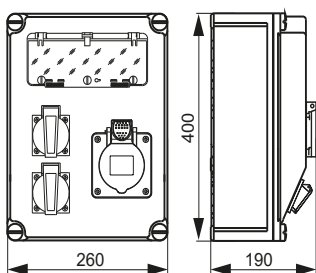

TDB12-12MV

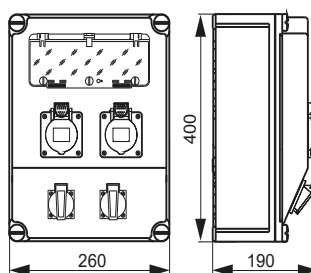

Üres ipari csatlakozó dobozok

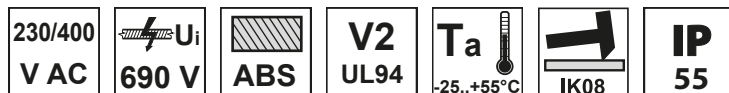

TDB351710



TDB302210

TRACON



TRACON	×	×17.5	H (mm)	W (mm)	D (mm)	a (mm)
TDB231377	6 × Ø22 mm (PG-16)	× 6	230	130	105	100
TDB351377	6 × Ø22 mm (PG-16)	× 6	350	130	105	220
TDB461377	6 × Ø22 mm (PG-16)	× 6	460	130	105	330
TDB351710	6 × Ø28,5 mm (PG-21)	× 6	360	180	110	227
TDB302210	6 × Ø22/28,5 mm (PG-16/PG-21) + 4 × Ø28,5/42 mm (PG-21/MG-40)	× 11	300	230	115	151



RELEVANT STANDARD
EN 62208

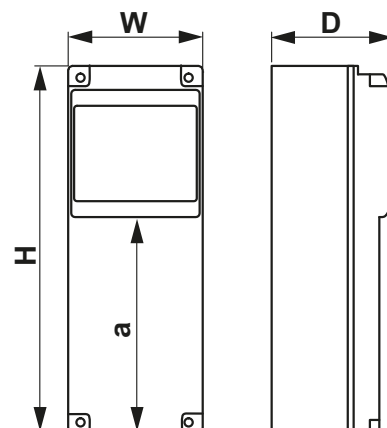

Üres ipari csatlakozó dobozok

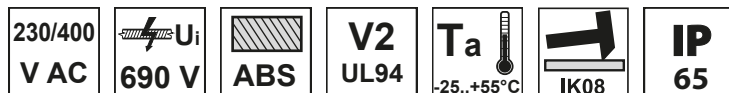

TDB683315



TDB503315



TDB362613



TDB333315

TRACON



TRACON	×	×17.5	H (mm)	W (mm)	D (mm)	a (mm)
TDB333315	8×MG20/25, 8×MG32/40, 2×MG40/50	16	330	330	150	120
TDB362613	4×MG20/25	12	400	260	150	200
TDB503315	8×MG20/25, 10×MG32/40, 2×MG40/50	16	506	330	150	255
TDB683315	10×MG20/25, 12×MG32/40, 2×MG40/50	32	685	330	150	270

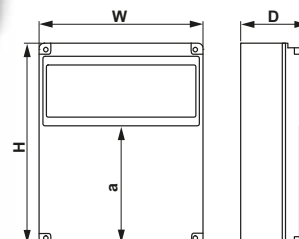

Rögzítő elem

TRACON



TICS-RE230

Schuko/French

TICS-RE400

CEE



TICS-RE230



TICS-RE400



Kábel tartó, kék



TRACON

W
(mm)

L
(mm)

H
(mm)

KT01

165

350

65



Kábel tartó, kék



TRACON

W
(mm)

L
(mm)

H
(mm)

KT02

115

435

5



Vízhatlan doboz



TRACON

W
(mm)

L
(mm)

H
(mm)

\varnothing mm

VD

90







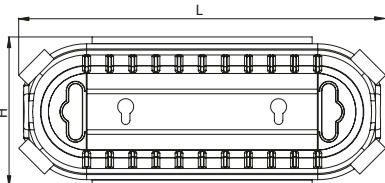
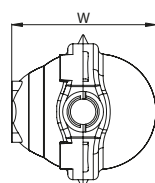



























210

90





6,5-11



Táblázat fejlécek piktogramjai

U_n Névleges feszültség (V)	I_n Névleges áram (A)	P_{max} Maximális terhelhetőség	 Kivágási méret (mm)
 Megjegyzés, kiegészítés	 Hangerő	 Beállítási tartomány	 Beállítási tartomány
 Fűtőteljesítmény	 Fűtőegység felületi hőmérséklete	 Szállított levegőmennyiség	×17,5mm  Sorok × modulok
 Füstszínű ajtó	 Fehér ajtó	 Átlátszó ajtóval	 Ajtó nélküli elosztódoboz
 Tartalmaz N/PE sítet.	 Ajtózár (db)	×17.5  Modulok száma	VDC VAC A  Érintkezők villamos adatai
 Menet	 Hajlítás	 Húzás	 Nm Meghúzási nyomaték
 Szín	 Bemenet	 Hosszúság	 Beköthető vezeték keresztmetszet
 Beköthető vezeték	 Tömeg	 Űrtartalom	 Furatátmérő
 Méretek (L×W×H)	 Rézsín	 Lemezvastagság	 Segédérintkezők
 Sín mérete (mm)			

Műszaki adatok piktogramjai

600/1000 V AC/DC Névleges feszültség (V)	I_n max. 250 A Névleges áram (A)	 U_i 1 kV Névleges szigetelési feszültség	U_{test} 1min 5 kV Próbafezültség
 690 V Beépíthető készülékek max. szigetelési feszültsége	IP 65 Védettségi fokozat	 I. érintésvédelmi osztály	 II. érintésvédelmi osztály
ABS Anyag: ABS	Cu Anyag: Sárgaréz	STEEL Anyaga: acél	Al Anyag: alumínium
 Tartalmaz N/PE sítet.	 Ajtónyitási szöge	 Szerelősínre szerelhető	 Rögzítés módja: betonalap
 Rögzítés módja: függőleges felületre	[mm²] 1,5-2,5 Beköthető vezeték	 Segédérintkezők	 Ütésállóság
V2 UL94 Lángállóság UL94 szerint	T_a Környezeti hőmérséklet -20...+80°C	 UV-álló	 Golyóscsapágy
 Zárópecsételhető			



Falon kívüli elosztódobozok 2



Süllyesztett elosztódobozok 2



Falon kívüli elosztódoboz, sík ajtóval 3



Süllyesztett elosztódobozok, sík ajtóval 4



Falon kívüli IP 65-ös elosztódobozok 6



Ajtó nélküli elosztódobozok 6



Ajtó nélküli elosztódobozok, zárpecsételhető 7



Védőburkolat sorolható készülékekhez 7



Műanyag elosztószekrények szerelőlapos ill. maszkos kivitel 8



Falon kívüli féMLEmez elosztódobozok 9



Süllyesztett féMLEmez elosztódobozok 9



FéMLEmez elosztószekrények maszkos kivitelben 10



Esővédő tető fém elosztószekrényekhez 10



Fém elosztószekrények 11



Csapófedeles kezelőablak 12



Fém szekrény szellőzőrács 12



Műanyag biztonsági zárok fémszekrényekhez 13



Tervtartó fémszekrényekhez 13



Kábelbevezető 13



Ívelt biztonsági üvegajtós fém elosztószekrény 14



Fémajtós fém elosztószekrény 15



Szűrőbetétes szellőztető ventilátorok 18



Elosztószekrények kompakt fűtőegységei 19



Kompakt fűtőegységek ventilátorral szerelve 19



Termosztátok (Hőmérséklet-szabályozók) 20



Higrosztát (Légnedvesség-szabályozó) 20

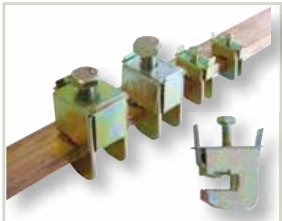

Gyűjtősin leágazó kapcsok 20



Állítható kábelrögítők 21



Támszigetelők 21

Falon kívüli elosztódobozok



TRACON		$\times 17.5$	H (mm)	W (mm)	D (mm)
EDFK-4/1	EDFKN-4/1	4	200	110	70
EDFK-6/1	EDFKN-6/1	6	205	150	75
EDFK-8/1	EDFKN-8/1	8	205	190	75
EDFK-12/1	EDFKN-12/1	12	205	260	75
EDFK-12/2	EDFKN-12/2	24	330	270	75
EDFK-14/3	EDFKN-14/3	42	475	310	85
EDFK-18/1	EDFKN-18/1	18	220	365	75

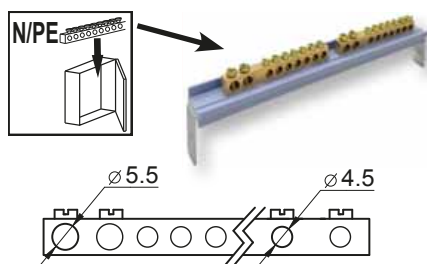

RELEVANT STANDARD
EN 62208

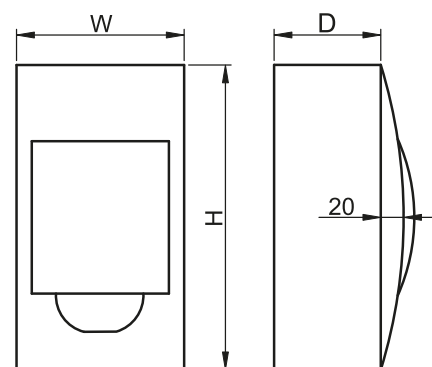

Süllyesztett elosztódobozok



TRACON		$\times 17.5$	H ₁ (mm)	W ₁ (mm)	D ₁ (mm)	H ₂ (mm)	W ₂ (mm)	D ₂ (mm)
EDS-4/1	EDSN-4/1	4	200	115	60	210	135	20
EDS-6/1	EDSN-6/1	6	200	160	60	210	170	20
EDS-8/1	EDSN-8/1	8	215	200	60	220	225	20
EDS-12/1	EDSN-12/1	12	200	260	60	220	280	20
EDS-12/2	EDSN-12/2	24	320	270	70	350	300	20
EDS-14/3	EDSN-14/3	42	475	310	75	500	340	20
EDS-18/1	EDSN-18/1	18	240	380	70	255	400	20

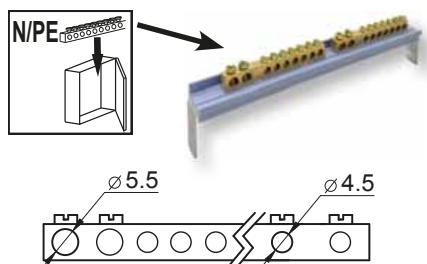

RELEVANT STANDARD
EN 62208

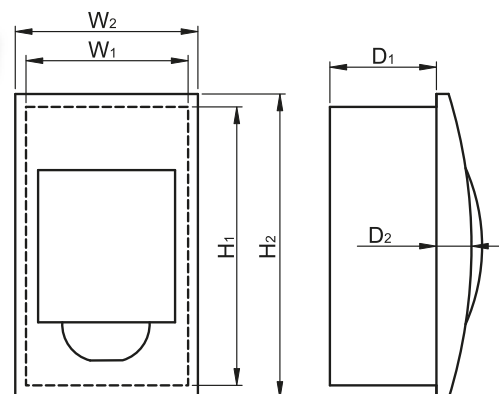

Falon kívüli elosztódoboz, sík ajtóval



TRACON		×17.5	H × W × D (mm)			
EDFKS-8/1	EDFKSN-8/1	1 × 8 (8)	195 × 240 × 90	–	–	–
EDFKS-12/1	EDFKSN-12/1	1 × 12 (12)	260 × 330 × 92	max. 2 × NPE-Z-24	–	–
EDFKS-12/2	EDFKSN-12/2	2 × 12 (24)	415 × 330 × 100	max. 2 × NPE-Z-24	max. 2 × ED-TLT12	max. 1 × ED-SEP12
EDFKS-12/3	EDFKSN-12/3	3 × 12 (36)	570 × 330 × 100	max. 2 × NPE-Z-24	max. 3 × ED-TLT12	max. 2 × ED-SEP12
EDFKS-18/2	EDFKSN-18/2	2 × 18 (36)	505 × 464 × 100	max. 2 × NPE-Z-38	max. 2 × ED-TLT18	max. 1 × ED-SEP18
EDFKS-18/3	EDFKSN-18/3	3 × 18 (54)	670 × 464 × 120	max. 2 × NPE-Z-38	max. 3 × ED-TLT18	max. 2 × ED-SEP18
EDFKS-18/4	EDFKSN-18/4	4 × 18 (72)	872 × 464 × 120	max. 4 × NPE-Z-38	max. 4 × ED-TLT18	max. 3 × ED-SEP18

A doboz nem tartalmaz N/PE sínt!

- Ajtó 180°-ban nyitható
- Ajtónyitás iránya változtatható
- Speciális duplarugós zár
- Zárópecsételhető takarólap
- Forgatható belső konzol
- Hátsó és oldalsó kikönnyítések
- Kiegészítő elválasztó lapok
- Kiegészítő takarólapok
- Kiegészítő N/PE sínek

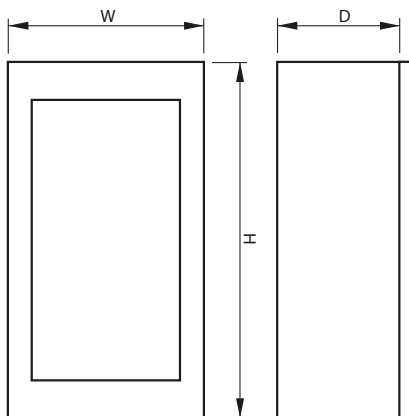







F/14-28



J/10-17

Süllyesztett elosztódobozok, sík ajtóval



TRACON			ACCESORIES				
			$H_1 \times W_1 \times D_1$ (mm)	$H_2 \times W_2 \times D_2$ (mm)			
EDSS-8/1	EDSSN-8/1	8	180 × 220 × 88	193 × 240 × 10	–	–	–
EDSS-12/1	EDSSN-12/1	12	240 × 305 × 80	262 × 330 × 10	max. 2 x NPE-Z-24	max. 1 x ED-TLT12	–
EDSS-12/2	EDSSN-12/2	24	395 × 305 × 85	420 × 330 × 17	max. 2 x NPE-Z-24	max. 2 x ED-TLT12	max. 1 x ED-SEP12
EDSS-12/3	EDSSN-12/3	36	545 × 305 × 85	570 × 330 × 17	max. 2 x NPE-Z-24	max. 3 x ED-TLT12	max. 2 x ED-SEP12
EDSS-18/1	EDSSN-18/1	18	270 × 440 × 85	300 × 465 × 17	max. 2 x NPE-Z-38	max. 1 x ED-TLT18	–
EDSS-18/2	EDSSN-18/2	36	480 × 440 × 90	505 × 465 × 17	max. 2 x NPE-Z-38	max. 2 x ED-TLT18	max. 1 x ED-SEP18
EDSS-18/3	EDSSN-18/3	54	655 × 440 × 90	685 × 465 × 20	max. 2 x NPE-Z-38	max. 3 x ED-TLT18	max. 2 x ED-SEP18
EDSS-18/4	EDSSN-18/4	72	860 × 440 × 95	880 × 465 × 20	max. 4 x NPE-Z-38	max. 4 x ED-TLT18	max. 3 x ED-SEP18

A doboz nem tartalmaz N/PE sínt!

- Ajtó 180°-ban nyitható
- Ajtónyitás iránya változtatható
- Speciális duplarugós zár
- Zárópecsételhető takarólap
- Forgatható belső konzol
- Hátsó és oldalsó kikönnyítések
- Kiegészítő elválasztó lapok
- Kiegészítő takarólapok
- Kiegészítő N/PE sínek

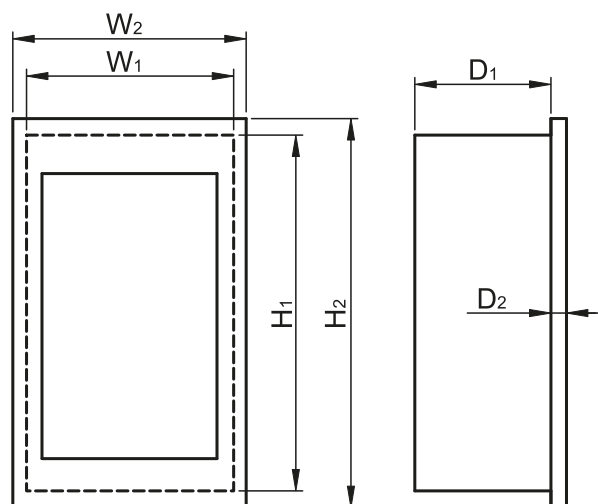

RELEVANT STANDARD
EN 62208



Súlyesztett elosztódoboz kiegészítők

Szigetelt N/PE sínek

230/400 V AC	In max. 100 A	U_i 500 V	Cu	IP 20	T_a -40..+85°C	V1 UL94
-----------------	----------------------------	-------------------------------	-----------	-----------------	------------------------------------	-------------------

Piktogramok H/O

TRACON	(mm)	x	In	mm ²	L (mm)	H (mm)	W (mm)	d (mm)	M
NPE-Z-24	6 × 9	24	max. 63 A	2,5-16	250	18,3	7,6	4 × 5,5 + 20 × 4,5	4 × M5 + 20 × M4
NPE-Z-38	8 × 12	38	max. 100 A	4-25	360	26,5	13,7	10 × 7,5 + 28 × 5,5	10 × M6 + 28 × M5

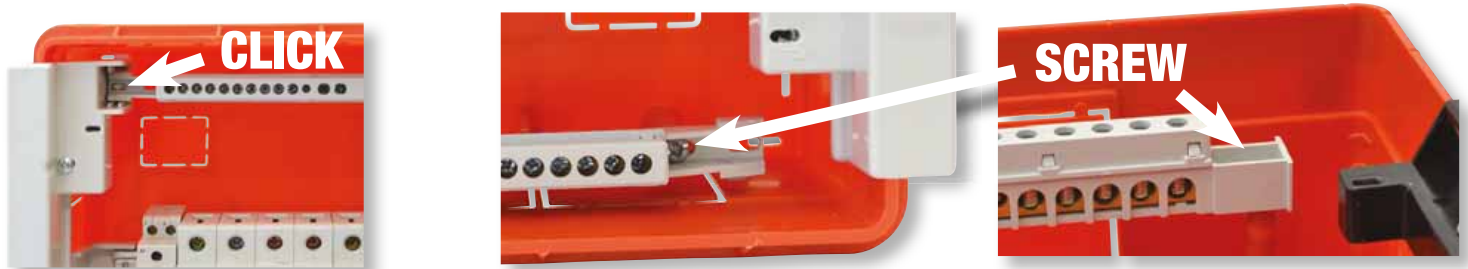

Teli takarólapok

T_a -25..+55°C	HB UL94	ABS
------------------------------------	-------------------	------------



TRACON	x17.5	
ED-TLT12	12 modul.	
ED-TLT18	18 modul.	

Elválasztó lapok

T_a -25..+55°C	HB UL94	ABS
------------------------------------	-------------------	------------



TRACON	x17.5	
ED-SEP12	12 modul.	
ED-SEP18	18 modul.	



Falonkívüli IP 65-ös elosztódobozok



TRACON	×17.5	H (mm)	W (mm)	D (mm)
EDFKIP65-4/1	4	210	140	100
EDFKIP65-8/1	8	210	215	100
EDFKIP65-12/1	12	260	300	140
EDFKIP65-18/1	18	285	410	140
EDFKIP65-12/2	24	415	300	140



RELEVANT STANDARD
EN 62208

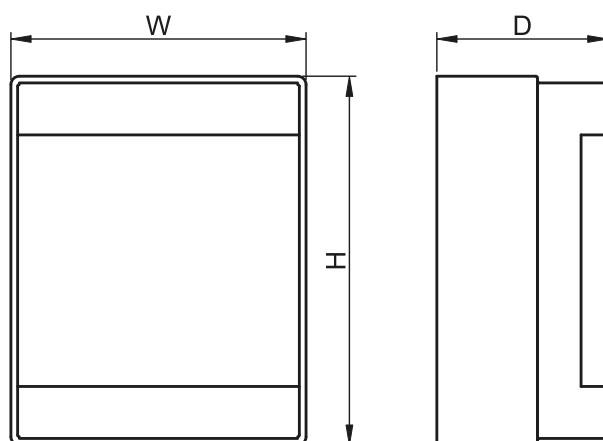

Ajtó nélküli elosztódobozok

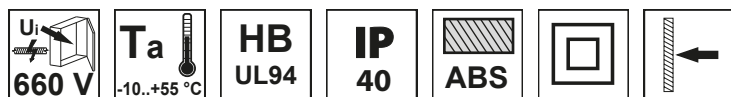

TRACON	×17.5	H (mm)	W (mm)	D (mm)	N/PE
EDFK-1/1AN	1	130	32	62	–
EDFK-2/1AN	2	130	52	62	–
EDFK-4/1AN	4	130	82	62	–
EDFK-8/1AN	8	160	160	62	✓
EDFK-12/1AN	12	160	260	65	✓
EDFK-18/1AN	18	160	365	60	✓

RELEVANT STANDARD
EN 62208

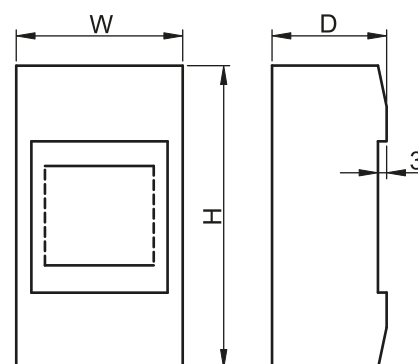

Ajtó nélküli elosztódozók, zárópecsételhető



TRACON	$\times 17.5$	H (mm)	W (mm)	D (mm)
EDFK-1/1ANP	1	140	35	60
EDFK-2/1ANP	2	140	50	60
EDFK-4/1ANP	4	140	90	60
EDFK-8/1ANP	8	160	180	60

RELEVANT STANDARD
EN 60670

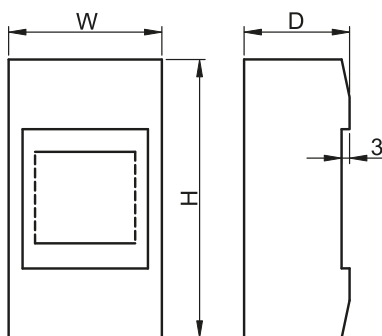

Védőburkolat sorolható készülékekhez, zárópecsételhető



TRACON	$\times 17.5$	35 \times 7.5	
TDT	1	✓	-
TDT-2	1	-	✓

A védőburkolat a sínre szerelt egy modul szélességű elemeknek nyújt elszigetelt védelmet, de a biztosított elem kezelőszervei hozzáférhetőek maradnak. A burkolat plombálható, így könnyen meggyőződhetünk róla, hogy a biztosított elem sértetlen.

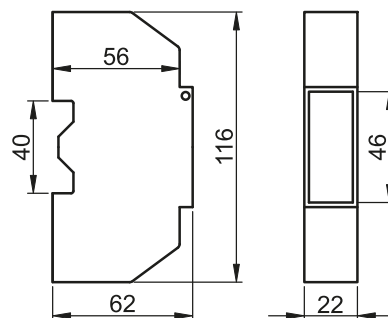

RELEVANT STANDARD
EN 60670



Takaróidom elosztódozókhoz

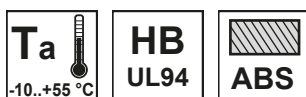

TRACON	$\times 17.5$
EDTM	$8 \times 1/2 + 2 \times 1 = 6$

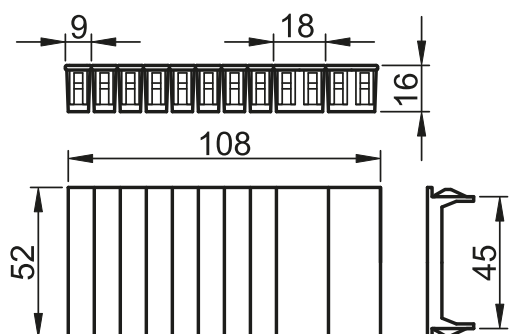

Segítségével lefedhetjük az elosztódozókban a modulok melletti esetleges szabad nyílásokat. Így az esztétikai hatáson túl, fokozottan védetté válik az elosztódozó véletlen érintés és szennyeződés ellen. A szükséges modulméretet egyszerűen le-törhetjük. Az egység 8 db fél modul (9 mm) ill. 2 db teljes modul (18 mm) szélességű elemből áll.

Műanyag elosztószekrények, szerelőlapos / maszkos kivitel, átlátszó / teli ajtó



TRACON				H (mm)	W (mm)	D (mm)	×17,5mm Σs	X	NPE
TME282113*	TME282113T*	TME282113M	TME282113MT	280	210	130	1 × 8	1	–
TME332513*	TME332513T*	TME332513M	TME332513MT	330	250	130	2 × 9	1	–
TME403017*	TME403017T*	TME403017M	TME403017MT	400	300	165	2 × 12	2	–
TME403020*	TME403020T*	–	–	400	300	195	–	2	–
TME504018*	TME504018T*	TME504018M	TME504018MT	500	400	175	3 × 17	2	–
TME604020*	TME604020T*	TME604020M	TME604020MT	600	400	200	4 × 17	2	–
TME605022*	TME605022T	TME605022M	TME605022MT	600	500	220	3 × 22	2	–
TME705025*	TME705025T*	TME705025M	TME705025MT	700	500	245	4 × 22	2	–

* szerelőlappal

Kulcsos zár

TME-ZMH



Biztonsági zár

TME-ZM



- Műanyag testű zár, fém betéttel, 180°-os elfordítással. Beépítésével a TME szekrény megtartja IP 65 védetségét.
- Kulcs kivitel: egységkulcs (nyitott és zárt állapotban is kivethető)

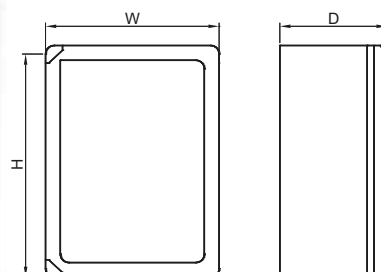

RELEVANT STANDARD
EN 62208

Esővédő tető

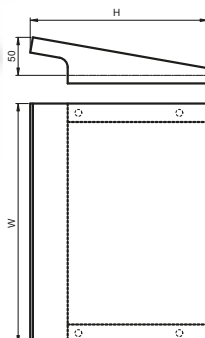

TRACON	W (mm)	H (mm)
TME403017R	300	170
TME504018R	400	175
TME604020R	400	200
TME705025R	500	245

Falonkívüli fémlemez elosztódobozok

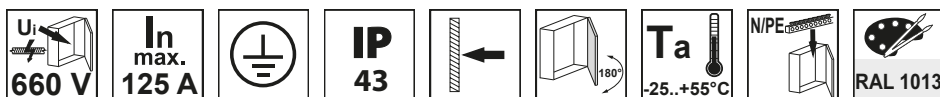

TRACON	×17,5mm Σs	×17,5	H (mm)	W (mm)	D (mm)
EDFKF-16/1	1 × 16	16	305	445	110
EDFKF-16/2	2 × 16	32	455	445	110
EDFKF-16/3	3 × 16	48	605	445	110
EDFKF-16/4	4 × 16	64	755	445	110

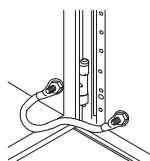
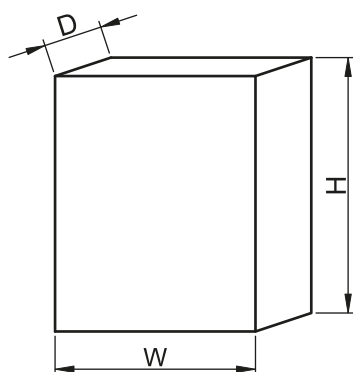

RELEVANT STANDARD
EN 62208

Süllyesztett fémlemez elosztódobozok

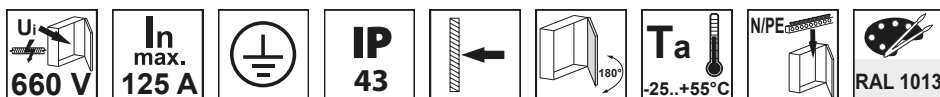

TRACON	×17,5mm Σs	×17,5	H (mm)	W (mm)	D (mm)
EDSF-16/1	1 × 16	16	326	464	115
EDSF-16/2	2 × 16	32	476	464	115
EDSF-16/3	3 × 16	48	626	464	115
EDSF-16/4	4 × 16	64	776	464	115

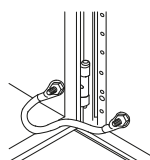
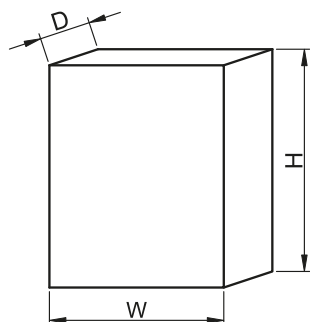

RELEVANT STANDARD
EN 62208



OLVASSA BE A KÓDOT!

- Nézze meg újdonságainkat
- Legyen naprakész

Kínálatunk gyorsan és folyamatosan fejlődik!
Katalógusunk a 2021. áprilisi állapotot tükrözi.

Naprakész információért
látogasson el honlapunkra!

Fém elosztószekrények maszkos kivitelben

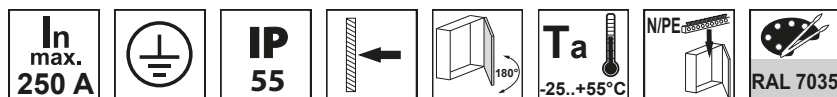

TRACON		×17,5mm Σs	×17.5 	H (mm)	W (mm)	D (mm)
TFE403020M	1	2 × 12	24	400	300	200
TFE504020M	2	3 × 16	48	500	400	200
TFE605020M	2	4 × 22	88	600	500	200
TFE806020M	2	5 × 27	135	800	600	200

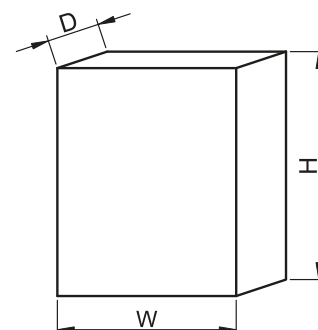
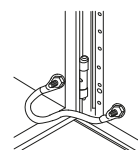

RELEVANT STANDARD
EN 62208

Esővédő tető fém elosztószekrényekhez

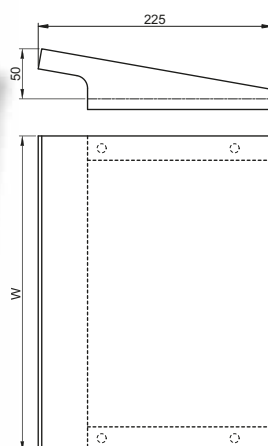

TRACON	W (mm)	H (mm)
TFE403020T	300	200
TFE504020T	400	200
TFE605020T	500	200
TFE806020T	600	200

Kültéri elhelyezés esetén, fokozott védelem elérésére használatos az esővédő tető, mely utólagosan rögzíthető a szekrények tetején a ráhegesztett csavarok segítségével.



Fém elosztószekrények

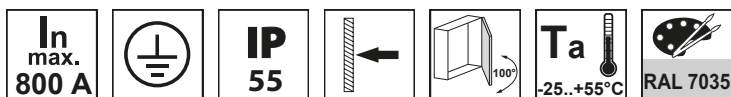

TRACON		H (mm)	W (mm)	D (mm)
TFE252015	1	250	200	150
TFE302515	1	300	250	150
TFE303015	1	300	300	150
TFE403015	1	400	300	150
TFE403020	1	400	300	200
TFE404020	1	400	400	200
TFE404025	1	400	400	250
TFE504015	1	500	400	150
TFE504020	1	500	400	200
TFE504025	1	500	400	250
TFE604020	2	600	400	200
TFE605015	2	600	500	150
TFE605020	2	600	500	200
TFE605025	2	600	500	250
TFE606025	2	600	600	250
TFE606030	2	600	600	300
TFE705020	2	700	500	200
TFE705025	2	700	500	250
TFE806020	2	800	600	200
TFE806025	2	800	600	250
TFE806030	2	800	600	300
TFE1006025	2	1000	600	250
TFE1008025	2	1000	800	250
TFE1008030	2	1000	800	300
TFE1008040	2	1000	800	400
TFE1208030	2	1200	800	300

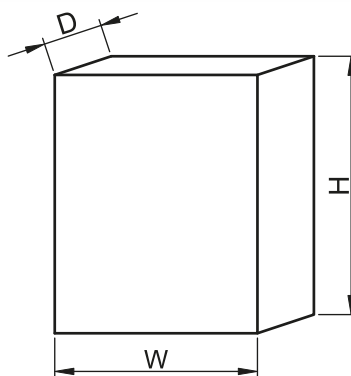

RELEVANT STANDARD
EN 62208

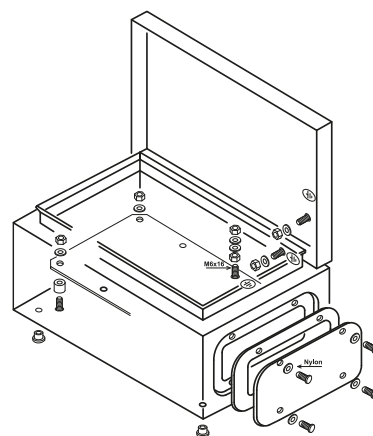

A TFE fém elosztószekrények széles méretválasztékban elérhetőek, a szerelőlapos szereléstechnika révén a szekrényben a készülékek szabadon elhelyezhetőek. A fém váz tökéletes merevséget biztosít a szerkezetnek, a szekrényeket ajtóval és szerelőlappal együtt szállítjuk. Az ajtó kéttollú zárbetéttel záródik, a biztonsági zárbetét külön rendelhető. Az ajtónyitás iránya a szekrény függőleges forgatásával, vagy a csuklópánt átszerelésével változtatható. L= 500 mm-ig 1 ponton, felette 2 ponton záródik.

A készülékek beépítését 800 A-ig ajánljuk.

Tartozékok



Csapófedeles kezelőablak

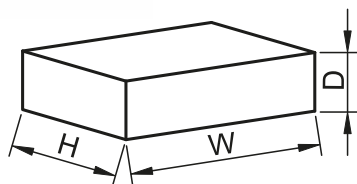
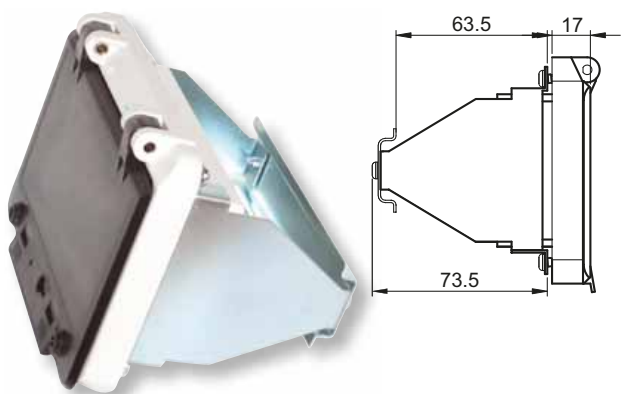

TRACON	×17.5	H × W × D (mm)	
TFE-KA8	8	162 × 98 × 95	65 × 148 mm
TFE-KA12	12	235 × 98 × 95	65 × 220 mm

A csapófedeles kezelőablak az elosztószekrények utólagos kiegészítőjeként a sorolható készülékek hozzáférését biztosítja a szekrény ajtajának kinyitása nélkül. A kezelőablakokhoz tartozék a sínrögző adapter, mellyel a készülékek megfelelő előlaptávolsággal szerelhetők fel. A szekrény burkolatát megfelelő méretben ki kell vágni. Ebbe a kivágott részbe kell beszüllyeszteni a kezelőablakot, majd csavarok segítségével a szekrény burkolatára lehet rögzíteni. Furatos fejű csavarok alkalmazása zárópecsételhetővé teszi a kezelőablakot. Védettségi fokozata IP 44, amit a felfekvő felület szigetelése és a zárható csapófedél biztosít. A közvetlen érintés elleni magas szintű védelmet a félmodulonként kitorheto, rögzített takarósáv biztosítja.

Fém szekrény szellőzőrács

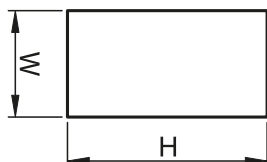

TRACON	W (mm)	H (mm)	
TFE-SZ1	150	200	115 × 160 mm
TFE-SZ2	140	140	100 × 100 mm
TFE-SZ3	115	200	50 × 160 mm

A szellőztetés igénye eredhet a készülékek által gerjesztett hőhatás, illetve a levegő magas páratartalma miatt. Amennyiben ezeknek a környezeti tényezőknek az értékei magasabbak a beépített készülékek megengedett paramétereinél, akkor a szekrényt szellőzéssel kell ellátni a megfelelő üzemi körülmények biztosításának érdekében. A szellőzés mértékét a szellőzőrács méretével lehet szabályozni, igény esetén több rács is ráépíthető a szekrényre. A megfelelő méretűre kivágott részre a szellőző a mellékelt tömítés elhelyezése után, a csavarok segítségével rögzíthető.

LED



FÉNYFORRÁSOK





E/86-105

Műanyag biztonsági zárok fémszekrényekhez

TRACON		
TFE-ZM2	5 mm	22,5 mm
TFE-ZT	5 mm	22,5 mm

- Műanyag testű zár, fém betéttel, 90°-os elfordítással. Beépítésével a TFE szekrény megtartja IP 55 védettségét.
- Kulcs kivitel: egységkulcs (műanyag fejjel, fém tollal)

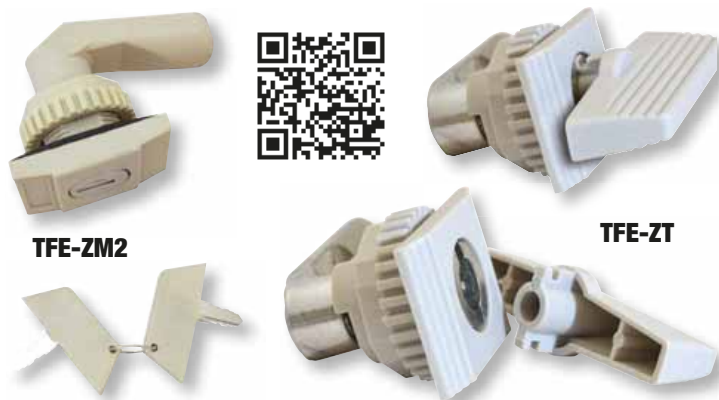

Tervtartó fémszekrényekhez

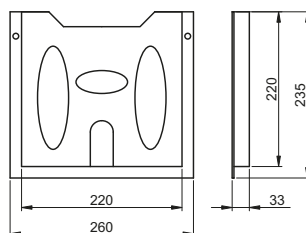

TRACON	
TFE-A4	A4

Az előírások szerint az elosztószekrények kivitelezésénél a vonatkozó tervek, kapcsolási rajzok elhelyezését biztosítani kell. A tervtartó A4 méretű dokumentumok befogadására képes, hátoldalán öntapadós csíkkal ellátott, de igény szerint csavarokkal is rögzíthető.

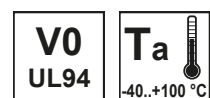

Kábelbevezető



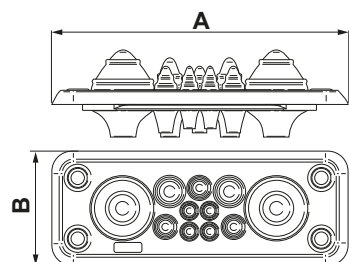

TRACON	 Ø mm													A × B (mm)	
	3-7	3,5-11	5-10	7-12	7-13	9-16	10-14	10-30	14-18	14-22	14-35	15-25			24-54
EKBV-01	-	-	-	-	-	-	-	-	-	× 4	-	-	-	× 4	138 × 48
EKBV-02	-	-	-	× 2	-	-	-	× 8	-	-	-	-	-	× 10	216 × 84
EKBV-03	-	-	-	-	-	-	× 5	-	× 4	× 3	-	-	× 2	× 14	222 × 92
EKBV-04	-	× 2	-	× 5	-	-	-	-	× 12	× 5	× 1	-	-	× 25	222 × 92
EKBV-05	-	-	-	-	× 50	-	-	-	-	-	-	× 1	-	× 51	222 × 92
EKBV-10	× 5	-	× 4	-	× 2	× 1	-	-	-	-	-	-	-	× 12	107 × 56
EKBV-16	× 12	-	-	-	× 5	-	-	-	-	-	-	-	-	× 17	127 × 56
EKBV-24	× 6	-	× 6	-	-	× 5	-	-	-	-	-	-	-	× 17	153 × 56

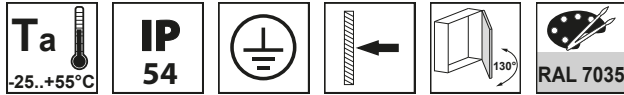

Ívelt biztonsági üvegajtós fém elosztószekrény



TRACON	×17,5mm Σs 	×17,5 	L (mm)	W (mm)	H (mm)
TGE606020	3 × 24	72	600	600	200
TGE607520	4 × 24	96	750	600	200
TGE609020	5 × 24	120	900	600	200
TGE6010520	6 × 24	144	1050	600	200
TGE6012025	7 × 24	168	1200	600	250
TGE6015025	9 × 24	216	1500	600	250
TGE6018025	11 × 24	264	1800	600	250

Az elosztószekrény nem tartalmaz N/PE sínt!

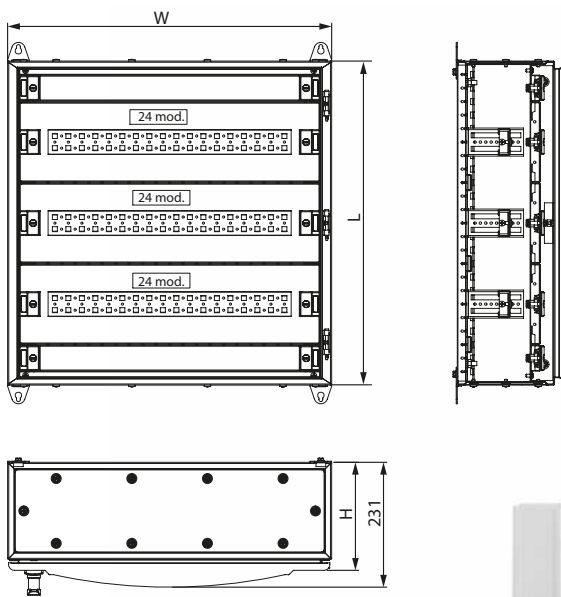

RELEVANT STANDARD
EN 572-1

RELEVANT STANDARD
EN 60670-24
EN 13501

Fémajtós fém elosztószekrény

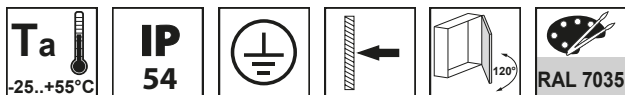

TRACON	×17,5mm Σs	×17,5	L (mm)	W (mm)	H (mm)
TGEF606020	3 × 24	72	600	600	200
TGEF607520	4 × 24	96	750	600	200
TGEF609020	5 × 24	120	900	600	200
TGEF6010520	6 × 24	144	1050	600	200
TGEF6012025	7 × 24	168	1200	600	250
TGEF6015025	9 × 24	216	1500	600	250
TGEF6018025	11 × 24	264	1800	600	250

Az elosztószekrény nem tartalmaz N/PE sánt!

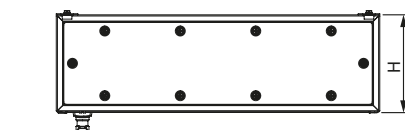
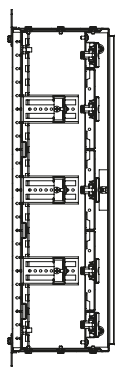
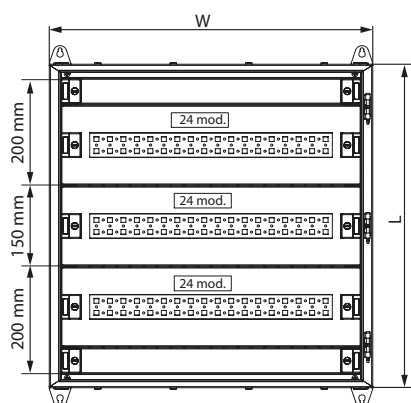

TGEF606020

TGEF6010520

TGEF6018025



OLVASSA BE A KÓDOT!

- Nézze meg újdonságainkat
- Legyen naprakész

Kínálatunk gyorsan és folyamatosan fejlődik!
Katalógusunk a 2021. áprilisi állapotot tükrözi.
Naprakész információért
látogasson el honlapunkra!

AKM

KOMPAKT MEGSZAKÍTÓ

TRACON
.....**ELECTRIC®**



I/2-5

Tartozékok

1. Szerelőlapok, takarólapok

TRACON	W (mm)	H (mm)	D (mm)
TGEBM150	495	150	13
TGEBM200	495	200	13
TGEMP150	450	150	20
TGEMP200	450	200	20

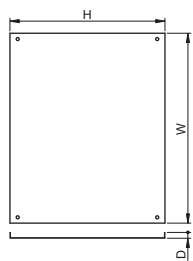

TGEBM...



TGEMP...

Az alsó és felső modulok magassága 200 mm, a közbensőké 150 mm.

2. Alapkeret padló telepítéshez

TRACON	W (mm)	H (mm)	D (mm)
TGEBF	600	180	50
TGEBF25	600	230	50

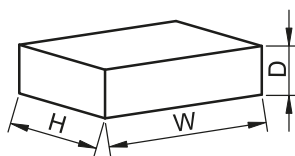

4. Fésűs kábel bevezető

TRACON	W (mm)	H (mm)	D (mm)
TGECE	568	152	6

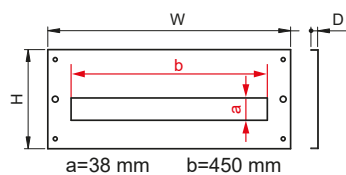

a=38 mm b=450 mm



5. Szigetelt földelő sín /N/PE/

TRACON	(mm)	X	In	mm ²	L (mm)	H (mm)	W (mm)	d (mm)	M	
NPE-Z-24	6 × 9	24	max. 63 A	2,5-16	2,5-10	250	18,3	7,6	4 × 5,5 + 20 × 4,5	4 × M5 + 20 × M4
NPE-Z-38	8 × 12	38	max. 100 A	4-25	2,5-16	360	26,5	13,7	10 × 7,5 + 28 × 5,5	10 × M6 + 28 × M5

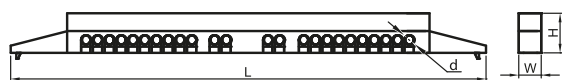

NPE-Z-38



NPE-Z-24

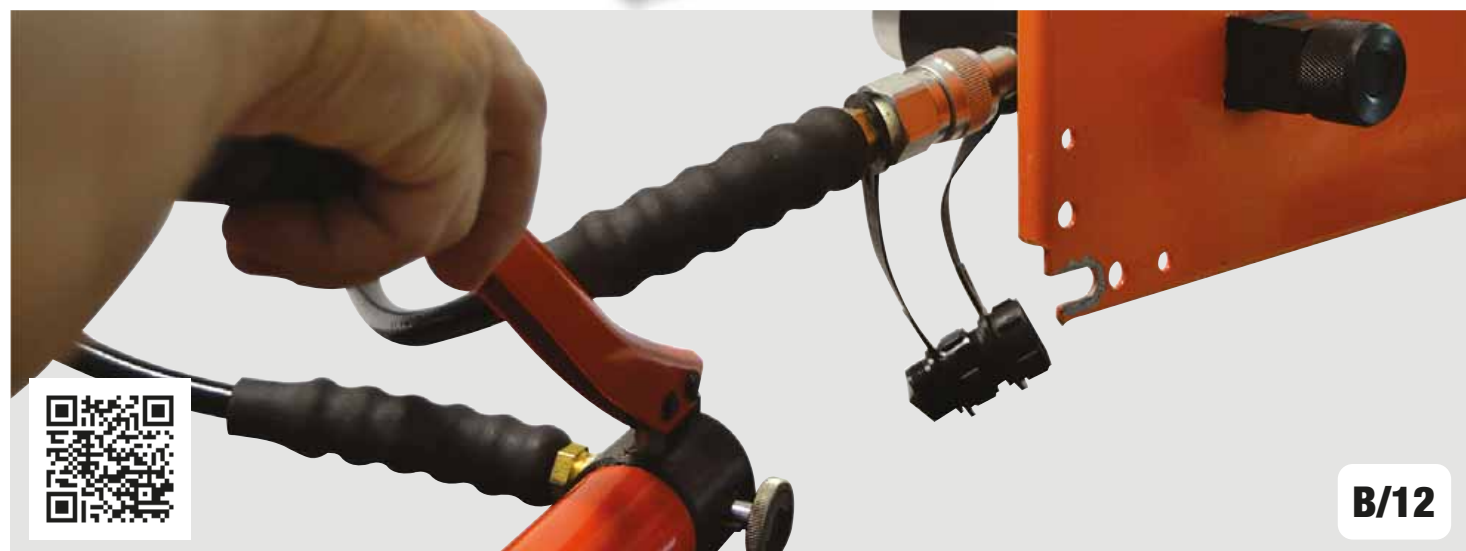

B/12

Szűrőbetétes szellőztető ventilátorok

230
V AC



IP
54

T_a
-10..+55 °C

Piktogramok H/O

TRACON	m³/h	I _n	P _{max}	dB (A)		A (mm)	C (mm)	D (mm)	E (mm)
V35	35* m³/h	0,07 A	12 W	31 dB (A)	V35-KNY	105	92	5	50
V43	43* m³/h	0,11 A	19 W	46 dB (A)	V43-KNY	150	124	5	61
V71	71* m³/h	0,11 A	19 W	46 dB (A)	V71-KNY	250	224	6	100
V150	150* m³/h	0,14 A	21 W	42 dB (A)	V150-KNY	150	125	5	50
V170	170* m³/h	0,28 A	41 W	54 dB (A)	V170-KNY	250	224	6	134
V215	215* m³/h	0,22 A	33 W	50 dB (A)	V215-KNY	250	221	7	115
V360	360* m³/h	0,34 A	64 W	54 dB (A)	V360-KNY	325	291	6	150
V375	375* m³/h	0,25 A	55 W	60 dB (A)	V375-KNY	325	291	7	150

* szűrő nélkül, kilépő levegőnyílás használata esetén

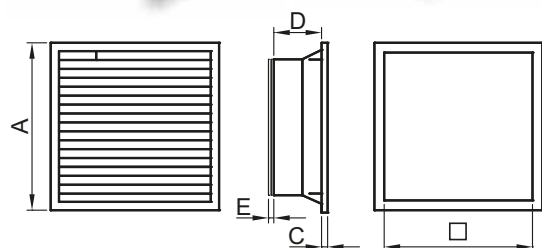

TRACON	A (mm)	C (mm)	D (mm)	E (mm)
V35-KNY	105	92	5	25
V43-KNY	150	124	5	23
V71-KNY	250	224	6	25
V150-KNY	150	125	5	25
V170-KNY	250	224	6	25
V215-KNY	250	221	7	25
V360-KNY	325	291	6	26
V375-KNY	325	291	7	30

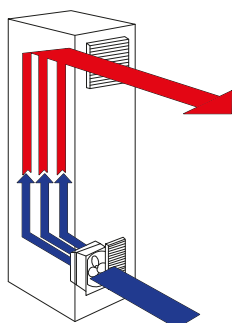

Főleg ipari alkalmazásra ajánljuk új szellőztető ventilátor családjunkat, különösen elosztószekrényekben, szerverszobákban, továbbá olyan helyeken ahol a beépített készülékek működőképessége miatt rendszeres átszellőztetésre van szükség. A felszerelésük egyszerű és gyors módon, csavarok nélkül, a rögzítőfülek bepattintásával végezhető. A ventilátorok és a kilépő levegőnyílások extra vékony szűrőbetéttel gyárilag ellátottak, melyek az esőcseppek és a 10 mikronnál nagyobb porszemek kivültartására hivatottak, így IP 54-es védetség érhető el. A ventilátor megfordításával a levegőáramlás iránya igény szerint megváltoztatható. A szellőztető ventilátorokat mindig az elosztószekrény alsó harmadába célszerű elhelyezni és mindig kilépő nyílással (szűrővel) együtt kell alkalmazni, valamint a rendszert termosztáttal is ellátva önműködő szellőztetést lehet kialakítani.

Elosztószekrények kompakt fűtőegységei

120-250 V AC/DC	IP 20	T_a -45...+70°C	[mm ²] 0,5-2,5		 35x7.5
--------------------	-----------------	-------------------------------------	-------------------------------	--	------------

TRACON	 P _{th}	H (mm)	 m
FE15	15 W	65	300 g
FE30	30 W	65	300 g
FE45	45 W	65	300 g
FE60	60 W	140	400 g
FE75	75 W	140	500 g
FE100	100 W	140	500 g
FE150	150 W	220	700 g

Az elosztószekrényen belüli kondenzvízképződés megelőzésére célszerű beépíteni a könnyen telepíthető kompakt fűtőegységeket. Ez különösen kültéri szekrényekben, téli időszakokban vagy hőmérsékletváltozásra érzékeny vezérlőelektronika beépítéskor lehet fontos. A fűtőegységek különféle fűtőtípusokkal választhatók 15-150 W-ig.

Felszerelésük egyszerűen elvégezhető, mivel a készülékek kalapsínre felpattinthatók.

A PTC hőelem elhelyezkedése miatt a beépítés mindig függőleges pozícióban történjen!

Nagy szekrények esetén célszerű több kisebb fűtőegység beszerelése az egyenletes hőelosztás miatt.

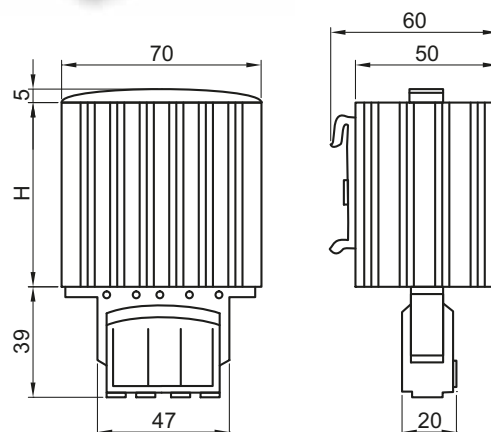

Kompakt fűtőegységek ventilátorral szerelve

230 V AC	IP 20	T_a -45...+70°C	[mm ²] 1,5-2,5		 35x7.5
-------------	-----------------	-------------------------------------	-------------------------------	--	------------

TRACON	 P _{th}	 m ³ /h	 T _h	H (mm)	 m
FEV250	250 W	45 m ³ /h	max. 75 °C	182	1.100 g
FEV400	400 W	45 m ³ /h	max. 75 °C	222	1.400 g

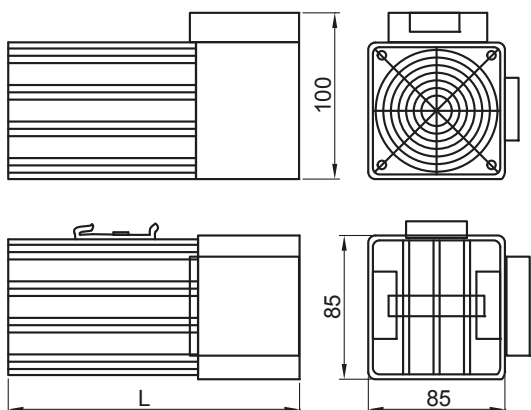

A normál fűtőegységek ventilátorral szerelt változataival nagyobb hatásfokú fűtést és jobb áramlási viszonyokat, egyenletesebb hőelosztást tudunk elérni. A funkció és a felépítés nagyban hasonlít az előzőekben tárgyaltakéhoz. A készülékek túlmelegedés elleni védelemmel ellátottak.

Termosztátok (Hőmérséklet-szabályozók)



THMS-11

230 V AC

IP 20

Ta
-20..+80°C

[mm²]
1,5-2,5

35×7.5

TRACON 

Model	Temp Range	VDC VAC	A	Relays	H × W × D (mm)
THMS-01	—	—	10 A	1 × NC	60 × 43 × 33
THMS-10	0-60 °C	250 V AC /	—	1 × NO	60 × 43 × 33
THMS-11	—	24 V DC	—	1 × NO	67 × 50 × 46

RELEVANT STANDARD
EN 60730-2-9

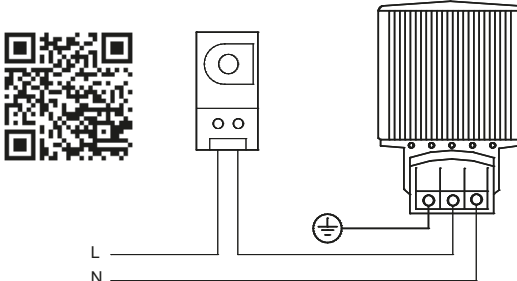

THMS-01

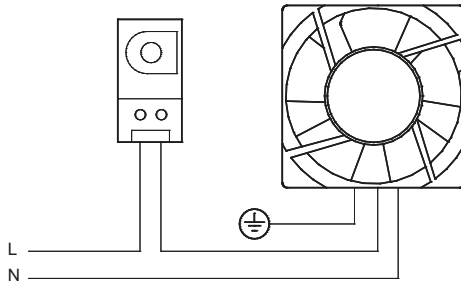

THMS-10

Higrosztát (Légnedvesség-szabályozó)



HGS-01

230 V AC

IP 20

Ta
-20..+80°C

[mm²]
1,5-2,5

35×7.5

TRACON 

Model	Humidity Range	VDC VAC	A	Relays	H × W × D (mm)
HGS-01	35-90 %	5 A 250 V AC	—	1 × CO	67 × 50 × 38

RELEVANT STANDARD
EN 60730-2-13

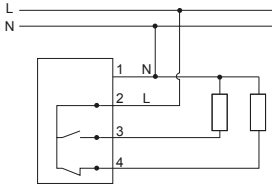

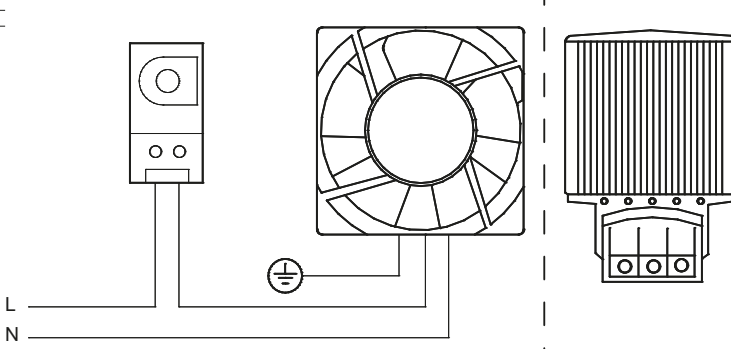

Gyűjtősín leágazó kapcsok

230/400 V AC

Cu



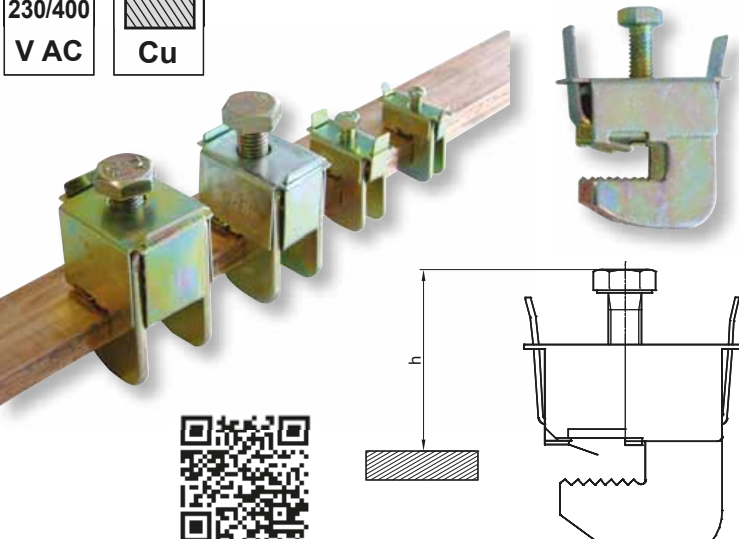

TRACON	mm ²	d	h _{min} (mm)	h _{max} (mm)
GLK1-0104	1-4	4-5 mm	17	23
GLK1-2516	2.5-16	4-5 mm	22	29
GLK1-1650	16-50	4-5 mm	26	39
GLK1-3570	35-70	4-5 mm	39	57
GLK2-0104	1-4	9-10 mm	17	23
GLK2-2516	2.5-16	9-10 mm	22	29
GLK2-1650	16-50	9-10 mm	26	39
GLK2-3570	35-70	9-10 mm	39	57
GLK2-70185	70-185	9-10 mm	44	66

Állítható kábelrögzítők

TRACON		B (mm)	H (mm)
AKR1-0612	6-12 mm	31	70
AKR1-1218	12-18 mm	24	70
AKR1-1822	18-22 mm	28	70
AKR1-2230	22-30 mm	39	85
AKR1-3038	30-38 mm	45	90
AKR1-3842	38-42 mm	47	95
AKR1-4250	42-50 mm	57	120
AKR1-5064	50-64 mm	70	130

Gyakran előfordul, hogy egy elosztószekrény csatlakozókábeleinek bekötésekor a bejövő kábeleket a készülékbe való bevezetés során rögzíteni kell. Ehhez ajánljuk kábelmegfogóinkat. A kampós kialakítású eszközt az előzetesen rögzített tartósínbe kell beakasztani, majd a kábellel együtt megszorítani.

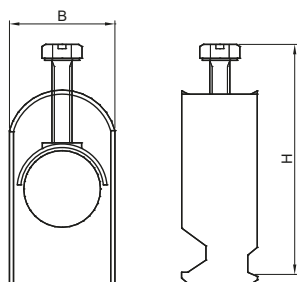



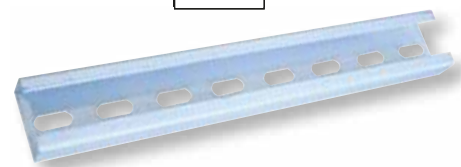
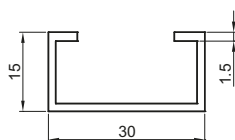

Rögzítősín állítható kábelrögzítőkhöz

TRACON	
30/15SIN	1 m



Támszigetelők

TRACON	H (mm)	M (mm)	D (mm)	B (mm)	A (mm)	 (N)	 (N)		
STS-25	25	6	24	26,5	9	3000	2000	3	28 g
STS-30-6	30	6	27	32,4	10	4600	3500	3	44 g
STS-30	30	8	27	32,4	10	4600	3500	6	44 g
STS-35-6	35	6	28	31,9	8	5500	4300	3	50 g
STS-35	35	8	28	31,9	8	5500	4300	6	50 g
STS-40-6	40	6	34	40,1	10	6200	5000	3	86 g
STS-40	40	8	34	40,1	10	6200	5000	6	86 g
STS-40-10	40	10	34	40,1	10	6200	5000	10	86 g
STS-51	51	8	29	35,3	13	6400	5250	6	83 g
STS-51-10	51	10	29	35,3	13	6400	5250	10	83 g
STS-51-12	51	12	29	35,3	13	6400	5250	14	83 g
STS-76	76	10	35	49,8	16	7000	5900	10	233 g

1.000 V AC	1.500 V DC	Utest 1min 5 kV
---------------	---------------	-----------------------

V0 UL94	Ta -40..+130 °C
------------	--------------------



A műanyag támszigetelők különféle biztosító aljzatok, gyűjtősínek, elosztó- és kapcsolószekrények, továbbá egyéb zárttéri villamos berendezések szereléséhez használhatók az adott feszültséghatáron belül. Alkalmazásuk a porcelán szigetelőkhöz képest méret- és tömegcsökkenést jelent. A támszigetelők halogénmentes epoxigyanta és kvarciszit megfelelő arányú keverékéből öntéssel készülnek. A rögzítésre szolgáló menetes fémbetéteket öntéskor helyezik a műanyag testbe. Jó mechanikai, termikus és elektromos tulajdonságokkal rendelkeznek. Szerelésük gyorsan és biztosan végezhető. Szükség esetén az üzemi feszültség több támszigetelő egymásra építésével növelhető.

RELEVANT STANDARD
EN 60660

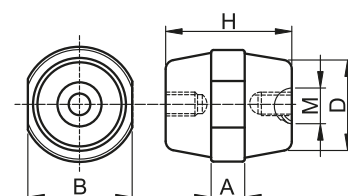

Táblázat fejlécek piktogramjai

U_m Névleges működtető feszültség	U_e Névleges üzemi feszültség	I_{th} Névleges termikus áram (A)	U_i Névleges szigetelési feszültség
I_e Névleges üzemi áram	I_n Névleges áram (A)	I_{cu} Névleges üzemi zárlati megszakítóképesség	I_s Áramfelvétel
I_m Termikus túlterhelési kioldó beállítási árama (A)	P_e Kapcsolható teljesítmény	P_m Saját teljesítményfelvétel	P_s Indítási teljesítmény
P_{ON} Teljesítményfelvétel - meghúzás	P_{HOLD} Teljesítményfelvétel - tartás	Ívkifúvási távolság (mm)	n Áramváltók száma
Mechanikus élettartam	Villamos élettartam	Érintkezők	Érintkező lefejtés
AUX Segédérintkezők	Alsó-felső kábelbevezetés	Alsó kábelbevezetés	Felső kábelbevezetés
Hajtástengely keresztmetszete	Sínközép távolság	Sín keresztmetszet	X Csavarok száma
Javasolt előtétbiztosító	Elektromos kapacitás	Optikai jelző	Beállítási időtartomány
IP65 Tokozva IP65	Méreték (L×W×H)	Beköthető vezeték-keresztmetszet	Megjegyzés, kiegészítés
Tömör, sodrott, hajlékony vezeték	Tömeg	Biztosító méret	

Műszaki adatok piktogramjai

U_m Névleges működtető feszültség 230 V AC	U_e Névleges üzemi feszültség 660 V	U_i Névleges szigetelési feszültség 690 V	U_{imp} Névleges lökfeszültség-állóság 6 kV
U_{test} Próbafeszültség 1min 1,8 kV	I_{th} Névleges termikus áram (A) 1 A	I_e Névleges üzemi áram 2 A	I_{cu} Névleges üzemi zárlati megszakítóképesség 120 kA_{eff}
50/60 Hz Névleges frekvencia	Class Ir Termikus kioldó kioldási osztálya 10A	UVR Kioldó típusa: feszültségcsökkenési	SHT Kioldó típusa: munkaáramú
P_m Saját teljesítményfelvétel 5 VA	P_{ON} Teljesítményfelvétel - meghúzás 30 VA	P_{HOLD} Teljesítményfelvétel - tartás 4,5 VA	10 A gG Javasolt előtétbiztosító
Mágneses hajtás	M Motoros hajtás	AC 6b Alkalmazási kategória	Rezgésállóság
AUX Segédérintkezők 2×CO	IP10 Védettség beépített állapotban: nyitott kezelőkar	IP20 Védettség beépített állapotban: zárt kezelőkar	IP 65 Védettségi fokozat
I. érintésvédelmi osztály	ON-OFF-ON... sc/h Kapcsolási gyakoriság ×4.800	Mechanikus élettartam ×10⁷	Villamos élettartam 6×10⁵
Hosszúság 350 mm	[mm²] Beköthető vezeték 2×1-2×6	Szerelősínre szerelhető 35×7.5	Függőleges síkra, a megengedett eltérés ±30°
2000 m Tengerszint feletti magasság	To Üzemi hőmérséklet -5..+40°C	Ta Környezeti hőmérséklet -25..+65°C	Relatív páratartalom max. 90 % rH



Kompakt megszakító AKM típus, beállítható TM kioldóval **2**



AKM Kézi működtető mechanizmusok (hajtások) **4**



AKM Villamos működtető mechanizmusok (hajtások) **5**



Kompakt megszakítók, KM **6**



Kézi működtető mechanizmusok (hajtások) **8**



Moduláris kompakt megszakítók **10**



Kékes biztosítók **12**



Biztosítóaljzatok **14**

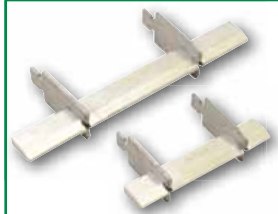

Rövidrezáró kések **15**



Szakaszolókapcsoló-biztosító hengeres biztosítóhoz **16**



Vízszintes szakaszolókapcsoló-biztosítók szerelőlapra **18**



Vízszintes szakaszolókapcsoló-biztosítók, gyűjtősínre szerelhető kivétel **19**



Függőleges szakaszolókapcsoló biztosítók **20**



COSMO 60 mm-es gyűjtősínrendszer **22**



Gyűjtősíntartók és burkolataik (60 mm sinközéptávolság) **22**



Leágazó kapcsok **22**

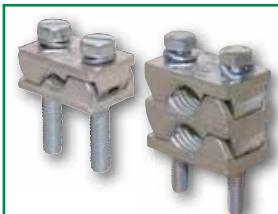

Prizma-kapocs **23**



Ipari kézikapcsolók **24**



Tokozatok **25**

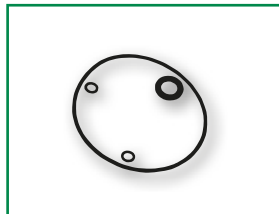

Tömítőkészletek **25**



Szakaszolókapcsoló **33**



Biztonsági szakaszolókapcsoló **34**



Segédkontaktorok **37**



Általános felhasználású kontaktorok **38**



Tokozott motorvédő kapcsoló kombinációk **40**



Nagyáramú kontaktorok **42**



Homlokoldali segédérintkezők **44**



Oldalsó segédérintkező egységek **45**



Időzőegységek **45**

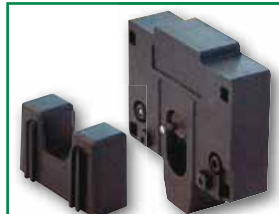

Mechanikus reteszelvek **45**



Termikus túláramvédelmi relék **46**



Kézi működtetésű motorvédőkapcsolók **50**



Homlokoldali segédérintkezők **52**



Munkaáramú kioldók **53**



Tokozatok **53**

Kompakt megszakító AKM típus, beállítható TM kioldóval

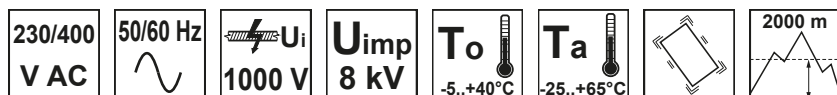

I_r	AKM1,-2,-3,-4	0,8-1 ($\times I_n$)
I_i	AKM1,-2,-3,-4	5-10 ($\times I_n$)
I_{cu} (kA _{eff}) AC 400 V	AKM1, AKM2	36
	AKM3, AKM4	50
I_{cs} (kA _{eff}) AC 400 V	AKM1, AKM2	25
	AKM3, AKM4	35
ON-OFF-ON... sc/h I_{max}	AKM1,-2	120
	AKM3,-4	60
	AKM1,-2	7000
	AKM3,-4	4000
	AKM1,-2	1000
	AKM3,-4	1000
	AKM1	1,50
	AKM2	1,92
	AKM3	5,00
	AKM4	5,25

TRACON	I_e	I_r	TRACON	I_e	I_r	TRACON	I_e	I_r	TRACON	I_e	I_r
AKM1-20	20	(16-20)	AKM1-63	63	(50,4-63)	AKM1-160	160	(128-160)	AKM3-400	400	(320-400)
AKM1-32	32	(25,6-32)	AKM1-80	80	(64-80)	AKM2-180	180	(144-180)	AKM4-630	630	(504-630)
AKM1-40	40	(32-40)	AKM1-125	125	(100-125)	AKM2-250	250	(200-250)			

Méretrajz (AKM1)

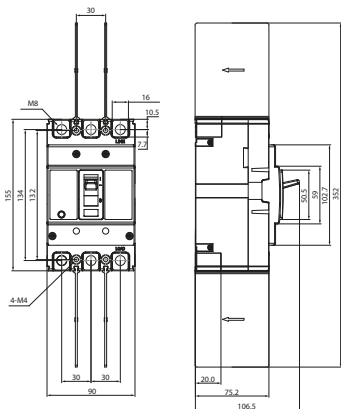

Méretrajz (AKM2)

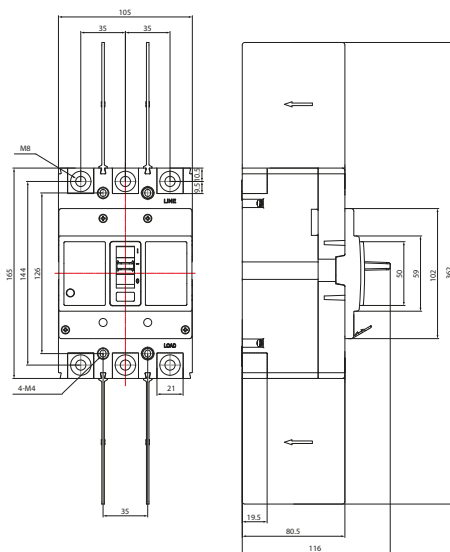

Méretrajz (AKM3,-4)

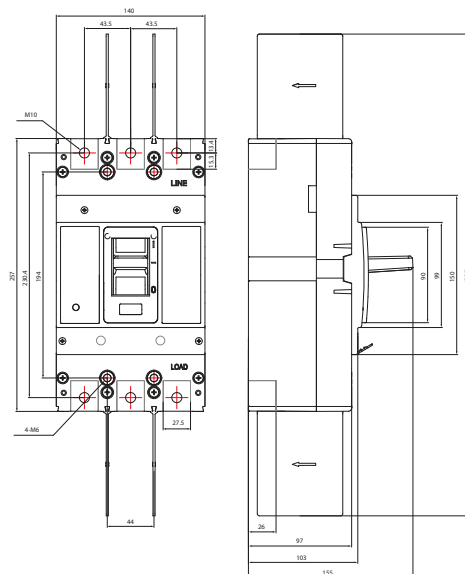

OLVASSA BE A KÓDOT!

- Nézze meg újdonságainkat
- Legyen naprakész

Kínálatunk gyorsan és folyamatosan fejlődik!
Katalógusunk a 2021. áprilisi állapotot tükrözi.

Naprakész információért
látogasson el honlapunkra!

Segédérintkező és kioldásjelző egységek

Típus	Funkció
Segédérintkező egységek:	A kompakt megszakító főérintkezőinek állapotjelzése
Hibajelző érintkező egységek:	A kompakt megszakító zárlat, túlterhelés vagy működtetés általi kioldásának jelzése
Hibajelző / segédérintkező	A két fenti egység összeépítésével létrehozott érintkező egység révén kombinált vezérlési feladatok is megvalósíthatók

I_{th} 1 A	AC 15	I_e 0,8 A	 350 mm
-----------------	----------	----------------	---

TRACON	Funkció		
AKM1AX1	Segédérintkező	AKM1-..	0,25 mm ²
AKM1AX2	Segédérintkező	AKM1-..	0,25 mm ²
AKM2AX1	Segédérintkező	AKM2-..	0,35 mm ²
AKM2AX2	Segédérintkező	AKM2-..	0,35 mm ²
AKM34AX1	Segédérintkező	AKM3,-4-..	0,35 mm ²
AKM34AX2	Segédérintkező	AKM3,-4-..	0,35 mm ²
AKM1AL	Kioldásjelző érintkező	AKM1-..	0,25 mm ²
AKM2AL	Kioldásjelző érintkező	AKM2-..	0,35 mm ²
AKM34AL	Kioldásjelző érintkező	AKM3,-4-..	0,35 mm ²
AKM1AXAL	Kioldásjelző- és segédérintkező	AKM1-..	0,25 mm ²
AKM2AXAL	Kioldásjelző- és segédérintkező	AKM2-..	0,35 mm ²
AKM34AXAL	Kioldásjelző- és segédérintkező	AKM3,-4-..	0,35 mm ²



AKM..AX.





AKM..AL

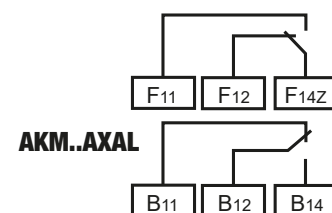
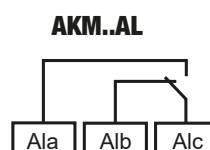
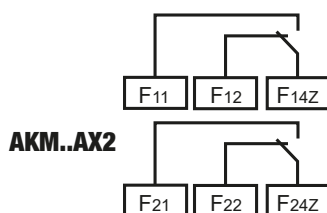
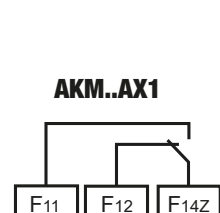

AKM..AXAL



Kioldó egységek (Munkaáramú (sönt), Feszültségcsökkenési)

TRACON	Funkció		
AKM1SHT230	Munkaáramú kioldó	AKM1-..	0,25 mm ²
AKM1SHT400	Munkaáramú kioldó	AKM1-..	0,25 mm ²
AKM1SHT24DC	Munkaáramú kioldó	AKM1-..	0,25 mm ²
AKM2SHT230	Munkaáramú kioldó	AKM2-..	0,35 mm ²
AKM2SHT400	Munkaáramú kioldó	AKM2-..	0,35 mm ²
AKM2SHT24DC	Munkaáramú kioldó	AKM2-..	0,35 mm ²
AKM34SHT230	Munkaáramú kioldó	AKM3,-4-..	0,35 mm ²
AKM34SHT400	Munkaáramú kioldó	AKM3,-4-..	0,35 mm ²
AKM34SHT24DC	Munkaáramú kioldó	AKM3,-4-..	0,35 mm ²
AKM1UVR	Feszültségcsökkenési kioldó	AKM1-..	0,25 mm ²
AKM2UVR	Feszültségcsökkenési kioldó	AKM2-..	0,35 mm ²
AKM34UVR	Feszültségcsökkenési kioldó	AKM3,-4-..	0,35 mm ²

U_m 230 V AC	 350 mm
-------------------	---



AKM.SHT...



AKM.UVR

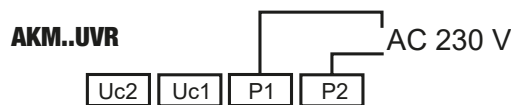
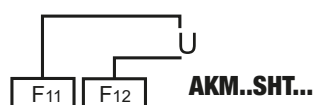



A munkaáramú kioldó segítségével a kompakt megszakító távműködtetéssel kikapcsolható. Az egység a működtető feszültség értékének 0,7-szeresétől már kikapcsolja a megszakítót. A működtető feszültség időtartama max 1s.

A feszültségcsökkenési kioldó a megszakító kioldását hozza létre, ha csatlakozókapcsain a feszültség értéke a névleges működtető feszültségének 35 – 70 %-a közé csökken. A kioldó megakadályozza a megszakító bekapcsolását, ha a kapcsain megjelenő feszültség a névleges működtető feszültségének 35 %-át nem éri el.



AKM Kézi működtető mechanizmusok (hajtások)



TRACON		A (mm)	B (mm)	H (mm)	
--------	---	-----------	-----------	-----------	---

AKM1HD	AKM1	125	35	47	7,6 × 7,6 / 152 mm
AKM2HD	AKM2	125	35	47	7,6 × 7,6 / 152 mm
AKM34HD	AKM3-AKM4	193	129	77	9,8 × 9,8 / 150 mm

A kézi működtető mechanizmus a megszakítók nyitható ajtón keresztüli hajtására szolgál. A kézi hajtás a megszakítóra szerelt működtetőrészből, a hajtástengelyből és az ajtóra szerelendő fogantyúból áll, amely jelzi a megszakító KI és BE helyzetét.

A működtetőkar a megszakító KI és BE helyzetében is lakatható.

A megszakító BE helyzetében az ajtón kívüli kar mechanikusan reteszelve van, ezért az ajtót nem lehet kinyitni.

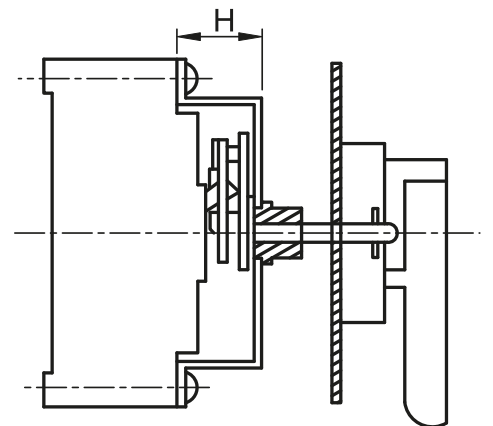
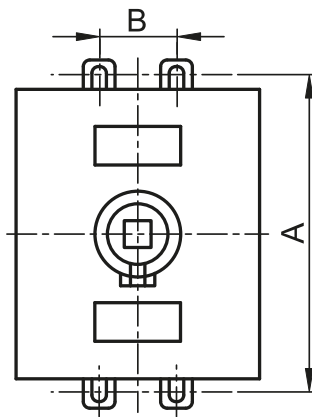
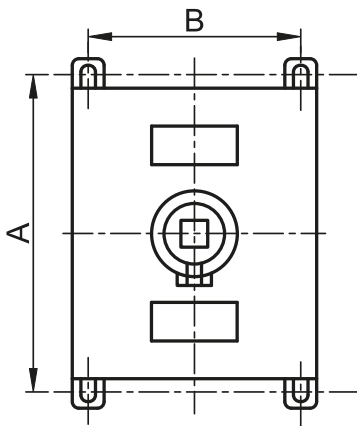

t (s) **Kioldási jelleggörbe**

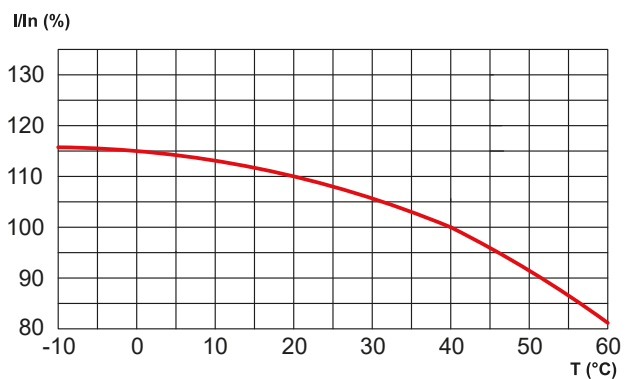
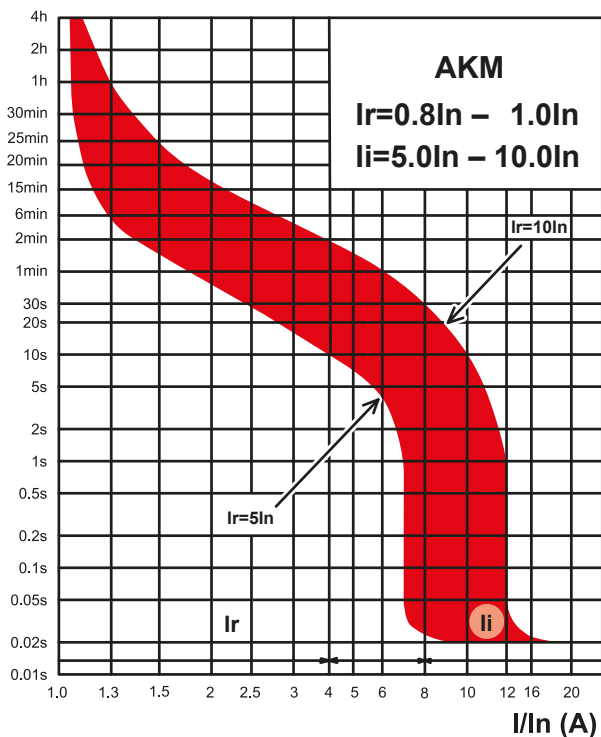

AKM Villamos működtető mechanizmusok (hajtások)



TRACON		I_s	P_s	A (mm)	B (mm)	H (mm)	
AKM1MD230		AKM1-..	< 0,5 A	14 W	127,5	29	97
AKM1MD400		AKM1-..	< 0,5 A	14 W	127,5	29	97
AKM2MD230		AKM2-..	< 0,5 A	14 W	128	35	102
AKM2MD400		AKM2-..	< 0,5 A	14 W	128	35	102
AKM34MD230		AKM3,-4-..	< 2 A	35 W	193	45	152
AKM34MD400		AKM3,-4-..	< 2 A	35 W	193	45	152

Az AKM..-MD... motoros hajtás segítségével lehetővé válik a helyszíni vagy távvezérlésű villamos működtetésű, nyomógombokkal vezérelt KI-BE kapcsolás. A motoros hajtás a megszakítóra szerelt működtetőrészből áll, amit kiegészít egy manuálisan működtethető kézi kar.

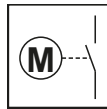

Motoros hajtás

Villamos bekötési vázlat és méretrajzok

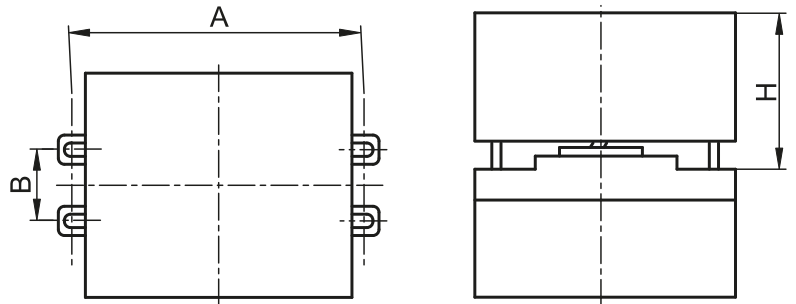
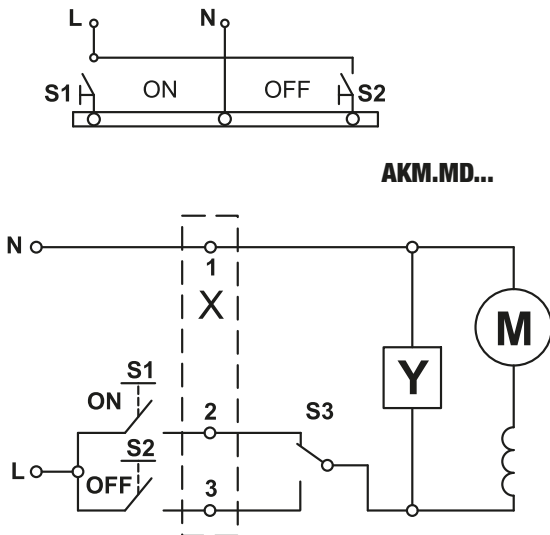

Jelmagyarázat

- M - motor
- Y - elektromos fék
- S3 - mikrokapcsoló
- X - sorkapocs
- S1, S2 - nyomógomb

Réz csatlakozóelemek

TRACON		A (mm)	B (mm)	H (mm)	C (mm)	E (mm)	d (mm)
AKM1TM	AKM1-..	40	15	4	24 ± 0,15	23,5	8,5
AKM2TM	AKM2-..	60	20	5	42 ± 0,15	27	9
AKM3TM	AKM3-..	70	28	6	43 ± 0,15	41	14,3
AKM4TM	AKM4-..	70	28	8	43 ± 0,15	41	14,3

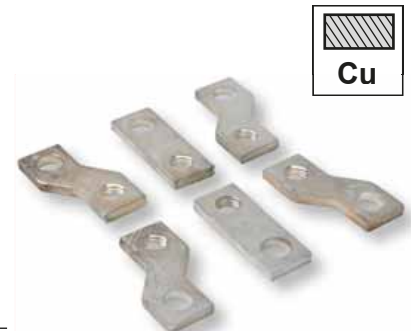
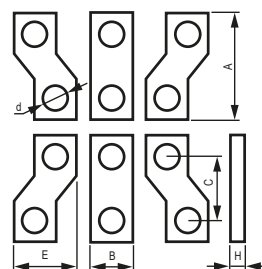

Kompakt megszakítók, KM

230/400
V AC

50/60 Hz

U_i
690 V

U_{imp}
6 kV



T_o
-5..+40°C

T_a
-5..+55°C



2000 m



Piktogramok

I/O



Termikus túlterhelési kioldó adatai

			$I_{th\ max.}$		I_e
KM1		1500	63 A	8500	32 A; 40 A; 50 A; 63 A
KM2		1500	100 A	8500	63 A; 80 A; 100 A
KM3		1000	160 A	7000	125 A; 140 A; 160 A
KM4		1000	225 A	7000	180 A; 200 A; 225 A
KM5		1000	350 A	7000	250 A; 315 A; 350 A
KM6		1000	630 A	4000	400 A; 500 A; 630 A
KM7		1000	800 A	4000	630 A; 700 A; 800 A

Mágneses zárlati kioldó adatai

		$I_{th\ max.}$	I_{cu}	
KM1		63 A	50 kA	0 mm
KM2		100 A	50 kA	0 (<50) mm
KM3		160 A	50 kA	0 (<50) mm
KM4		225 A	50 kA	<50 mm
KM5		350 A	50 kA	<50 mm
KM6		630 A	50 kA	100 mm
KM7		800 A	65 kA	100 mm

A környezeti hőmérséklet hatása a kioldási jelleggörbére

A tartós terhelhetőség határának a meghatározásához alkalmazható korrekciós tényezőt a teljes működési hőmérséklet-tartományra vonatkozóan a diagram segítségével állapíthatjuk meg. Amennyiben a megszakító felszerelési helyén a környezeti hőmérséklet meghaladja a + 40 °C értéket, az egyes méreteknél megengedhető maximális tartós terhelhetőségének meghatározását a következő táblázatban megadott korrekciós tényezők alkalmazásával kell végrehajtani.

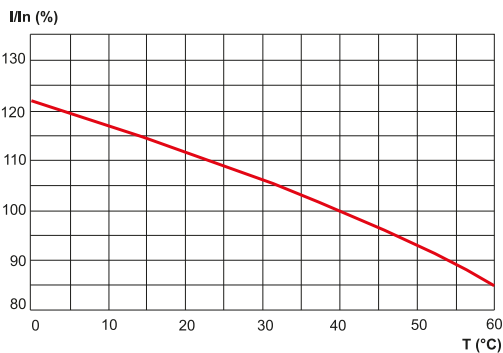

RELEVANT STANDARD
EN 60947-1

RELEVANT STANDARD
EN 60947-2

Korrekciós tényező

	T_a				
	40 – 45 °C	45 – 50 °C	50 – 55 °C	55 – 60 °C	60 – 65 °C
KM1	1,0	0,94	0,88	0,80	0,72
KM2	1,0	0,95	0,89	0,84	0,76
KM3	1,0	0,97	0,93	0,90	0,86
KM4	1,0	0,96	0,91	0,87	0,82
KM5	1,0	0,94	0,87	0,81	0,73
KM6	1,0	0,93	0,88	0,83	0,76
KM7	1,0	0,88	0,83	0,79	0,76

Kioldási jelleggörbe

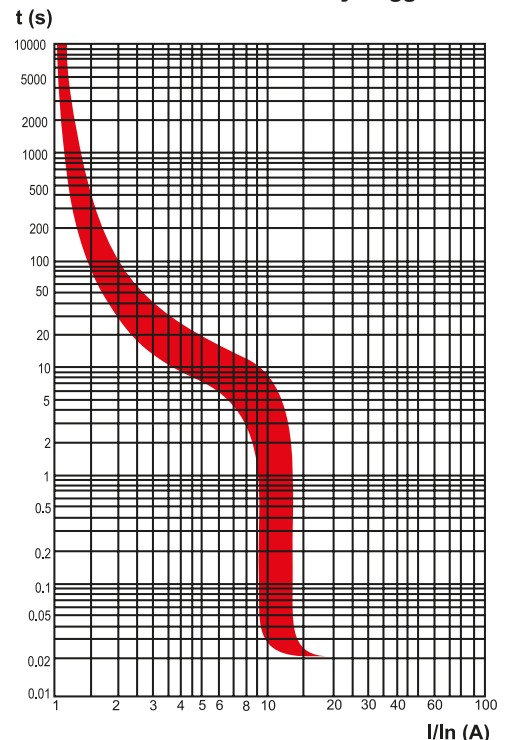

Beépített segédáramköri egységek

Feszültségcsökkenési kioldó

U_m	P_m
230 V AC	2,3 – 3,8 VA

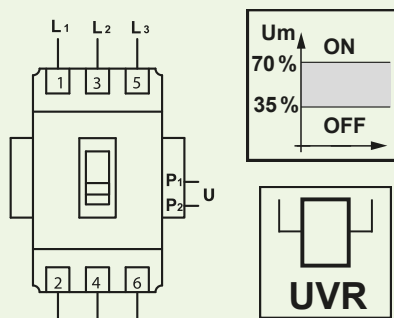

A feszültségcsökkenési kioldó a megszakító kioldását hozza létre, ha csatlakozókapcsain a feszültség értéke a névleges működtető feszültségének 35 – 70 %-a közé csökken. A kioldó megakadályozza a megszakító bekapcsolását, ha a kapcsain megjelenő feszültség a névleges működtető feszültségének 35 %-át nem éri el.

Munkaáramú (shunt) kioldó

U_m
230 V AC, 400 V AC, 220 V, DC

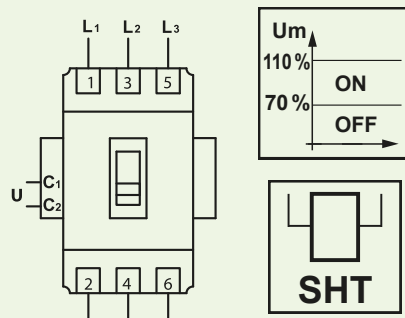

A munkaáramú kioldó segítségével a megszakító távműködtetéssel kikapcsolható, mivel a kioldó a készülék kioldását hozza létre, ha csatlakozókapcsaira a névleges működtető feszültségének 70 – 110 %-a közötti feszültséget kapcsolunk.

Segédérintkezők

U_e	I_e AC-15	U_i	I_{th}
230 V AC	1,2 A	690 V	10 A gG 3 A
400 V AC	0,5 A		

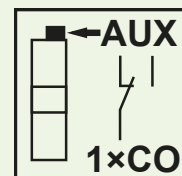

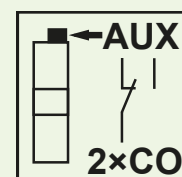

KM1-..
KM2-..
KM3-..
KM4-..



KM5-..
KM6-..
KM7-..

Kompakt megszakítók 1 váltó (1xCO) segédérintkezővel

TRACON	I_e		U_m
KM1-032/1C	32 A	SHT	220 V DC
KM1-032/2	32 A	UVR	230 V AC
KM1-040/1A	40 A	SHT	230 V AC
KM1-040/1B	40 A	SHT	400 V AC
KM1-040/1C	40 A	SHT	220 V DC
KM1-040/2	40 A	UVR	230 V AC
KM1-050/1B	50 A	SHT	400 V AC
KM1-050/1C	50 A	SHT	220 V DC
KM1-050/2	50 A	UVR	230 V AC
KM1-063/2	63 A	UVR	230 V AC
KM2-063/1A	63 A	SHT	230 V AC
KM2-063/1B	63 A	SHT	400 V AC
KM2-063/1C	63 A	SHT	220 V DC
KM2-063/2	63 A	UVR	230 V AC
KM2-080/1A	80 A	SHT	230 V AC
KM2-080/1C	80 A	SHT	220 V DC
KM2-080/2	80 A	UVR	230 V AC

TRACON	I_e		U_m
KM2-100/1C	100 A	SHT	220 V DC
KM2-100/2	100 A	UVR	230 V AC
KM3-125/1C	125 A	SHT	220 V DC
KM3-125/2	125 A	UVR	230 V AC
KM3-140/1B	140 A	SHT	400 V AC
KM3-140/1C	140 A	SHT	220 V DC
KM3-140/2	140 A	UVR	230 V AC
KM3-160/1C	160 A	SHT	220 V DC
KM3-160/2	160 A	UVR	230 V AC
KM4-180/1B	180 A	SHT	400 V AC
KM4-180/1C	180 A	SHT	220 V DC
KM4-180/2	180 A	UVR	230 V AC
KM4-200/1B	200 A	SHT	400 V AC
KM4-200/1C	200 A	SHT	220 V DC
KM4-200/2	200 A	UVR	230 V AC
KM4-225/1B	225 A	SHT	400 V AC
KM4-225/1C	225 A	SHT	220 V DC
KM4-225/2	225 A	UVR	230 V AC





OLVASSA BE A KÓDOT!

- Nézze meg újdonságainkat
- Legyen naprakész

Kínálatunk gyorsan és folyamatosan fejlődik!
Katalógusunk a 2021. áprilisi állapotot tükrözi.
Naprakész információért
látogasson el honlapunkra!

Kompakt megszakítók 2 váltó (2×CO) segédérintkezővel

TRACON	I _e		U _m
KM5-250/1C	250 A	SHT	220 V DC
KM5-250/2	250 A	UVR	230 V AC
KM5-315/2	315 A	UVR	230 V AC
KM5-350/1C	350 A	SHT	220 V DC
KM5-350/2	350 A	UVR	230 V AC
KM6-400/1C	400 A	SHT	220 V DC
KM6-500/1A	500 A	SHT	230 V AC
KM6-500/1B	500 A	SHT	400 V AC

TRACON	I _e		U _m
KM6-500/1C	500 A	SHT	220 V DC
KM6-500/2	500 A	UVR	230 V AC
KM6-630/1C	630 A	SHT	220 V DC
KM6-630/2	630 A	UVR	230 V AC
KM7-630/1A	630 A	SHT	230 V AC
KM7-630/1B	630 A	SHT	400 V AC
KM7-630/1C	630 A	SHT	220 V DC
KM7-630/2	630 A	UVR	230 V AC
KM7-700/1A	700 A	SHT	230 V AC
KM7-700/1B	700 A	SHT	400 V AC
KM7-700/2	700 A	UVR	230 V AC
KM7-800/1B	800 A	SHT	400 V AC
KM7-800/2	800 A	UVR	230 V AC

SHT: Söntkioldó /Munkááramú kioldó

UVR: Feszültségcsökkenési kioldó

Méretrajz és felerősítési furat

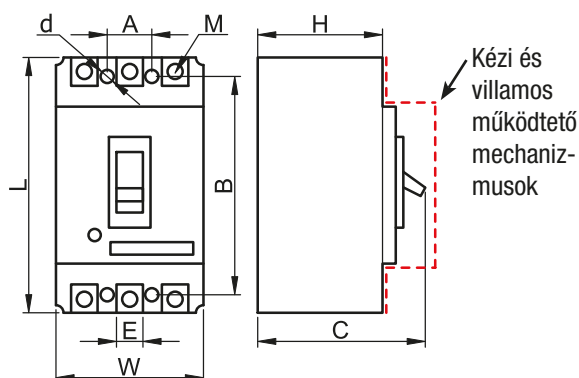



Kézi és villamos működtető mechanizmusok

	W (mm)	L (mm)	H (mm)	C (mm)	A (mm)	B (mm)	E (mm)	M (mm)	d (mm)
KM1	78	136	74	98	25	117	13.5	M5	3.5
KM2	92	150	80	104	30	129	18	M8	4.5
KM3	107	165	98	127	35	126	23	M8	5
KM4	107	165	98	127	35	126	23	M8	5
KM5	150	257	98	155	44	194	32	M10	7
KM6	182	270	105	160	58	200	43	M12	7
KM7	210	280	98	142	70	243	43	M12	7

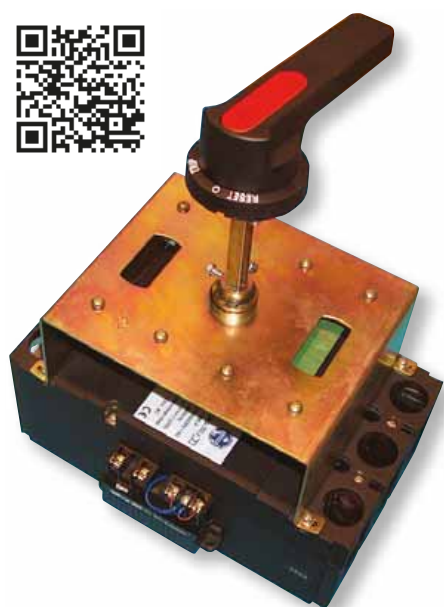
Kézi működtető mechanizmusok (hajtások)



TRACON		A (mm)	B (mm)	H (mm)	
KM1-HM	KM1	102	25	50	8 × 8 / 150 mm
KM2-HM	KM2	104	30	53	8 × 8 / 150 mm
KM4-HM	KM3-KM4	142	35	56	8 × 8 / 150 mm

A kézi működtető mechanizmus a megszakítók nyitható ajtón keresztüli hajtására szolgál. A kézi hajtás a megszakítóra szerelt működtetőrészből, a hajtástengelyből és az ajtóra szerelendő fogantyúból áll, amely jelzi a megszakító KI és BE helyzetét.

A működtetőkar a megszakító KI és BE helyzetében is lakatolható.

A megszakító BE helyzetében az ajtón kívüli kar mechanikusan reteszelve van, ezért az ajtót nem lehet kinyitni.



OLVASSA BE A KÓDOT!

- Nézze meg újdonságainkat
- Legyen naprakész

Kínálatunk gyorsan és folyamatosan fejlődik!
Katalógusunk a 2021. áprilisi állapotot tükrözi.

Naprakész információért
látogasson el honlapunkra!

Felerősítési furatok

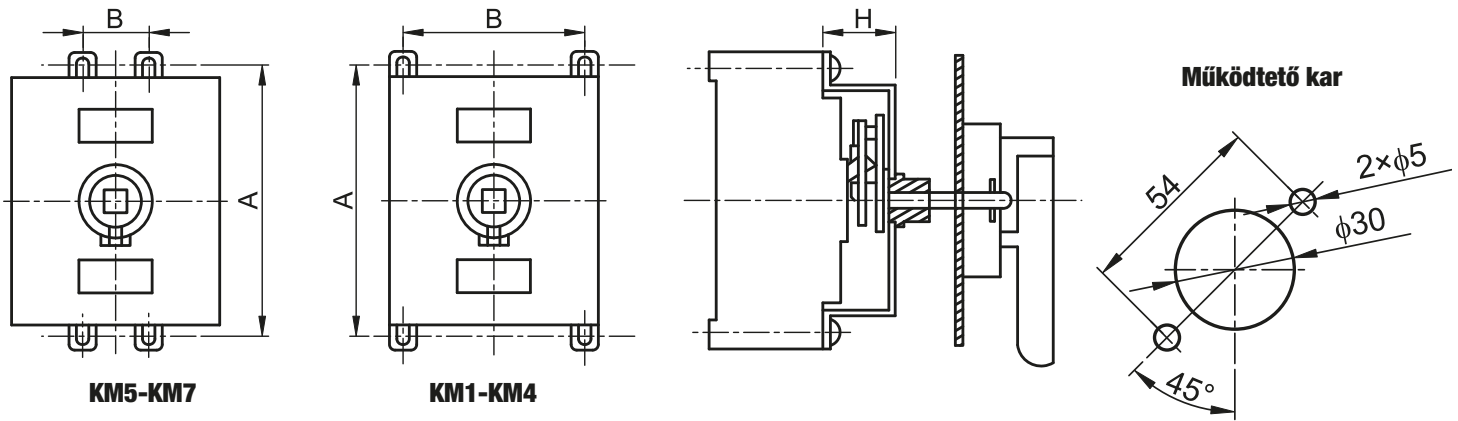

Villamos működtető mechanizmusok (hajtások)

230 V AC, 50/60 Hz, Utest 1min 1,8 kV, To -5..+40°C, Ta -5..+55°C, max. 90% rH, 2000 m

Piktogramok I/O

TRACON		I _s	P _s	A (mm)	B (mm)	H (mm)	
KM7-PM		KM7	< 7,5 A	2000 W	240	70	140

A KM...PM villamos működtető mechanizmus segítségével lehetővé válik a helyszíni vagy távvezérlésű villamos működtetésű, nyomógombokkal vezérelt KI-BE kapcsolás. A villamos hajtás a megszakítóra szerelt működtetőrészből áll, amit kiegészít egy manuálisan működtethető kézi kar. KM1...KM4 méret nagyságú kompakt megszakítók esetén mágneses rendszerű a KI-BE kapcsolás. KM5...KM7 méret nagyságú megszakító típusok esetén motoros rendszerű hajtást alkalmazunk.

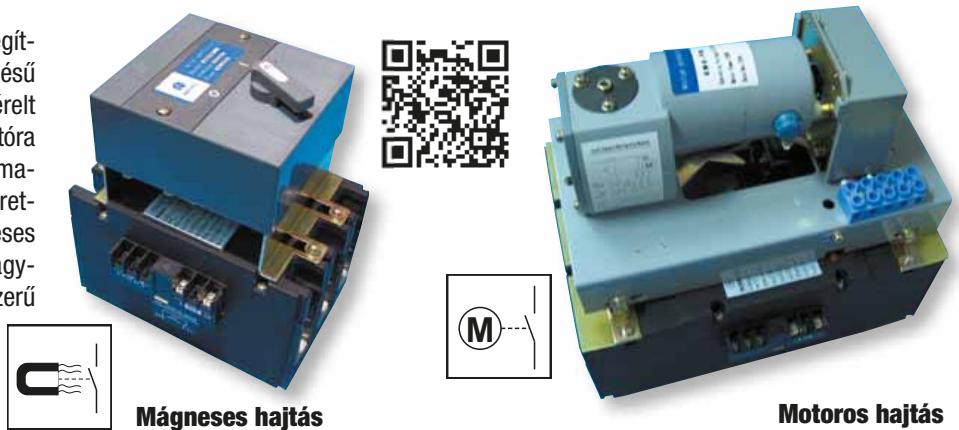

Mágneses hajtás

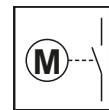

Motoros hajtás

Villamos bekötési vázlat és méretrajzok

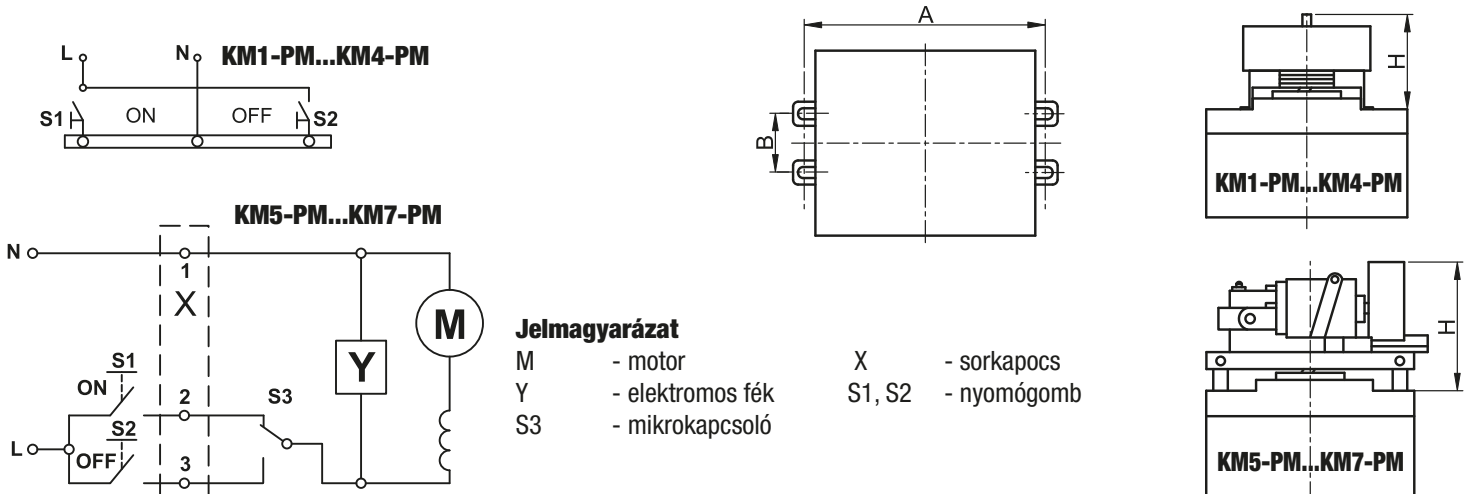

Kompakt megszakítók, MKM

230/400
V AC

50/60 Hz

U_i
500 V

U_{imp}
6 kV

3P

T_o
-5..+40°C

T_a
-25..+65°C

2000 m

2000 m

Piktogramok I/O



	MKM1	MKM2
I_e (A)	15, 20, 25, 30, 40, 50, 60, 75, 80, 100	125, 160, 225, 250
I_{cu} (kA _{eff}) AC	220/240 V	50
	380 V	30
I_{cs}/I_{cu} (%)	400 V	20
	220/240 V	25 %
I_{cs}/I_{cu} (%)	380 V	25 %
	400 V	25 %
ON-OFF-ON... sc/h	× 10	× 5
(×10 ⁵)	8.500	8.500
(×10 ⁵)	4.000	4.000
	0,78 kg	1,3 kg

TRACON	I_e	TRACON	I_e	TRACON	I_e	TRACON	I_e
MKM1-15	15 A	MKM1-40	40 A	MKM1-80	80 A	MKM2-225	225 A
MKM1-20	20 A	MKM1-50	50 A	MKM1-100	100 A	MKM2-250	250 A
MKM1-25	25 A	MKM1-60	60 A	MKM2-125	125 A		
MKM1-30	30 A	MKM1-75	75 A	MKM2-160	160 A		

Méretrajz (MKM1)

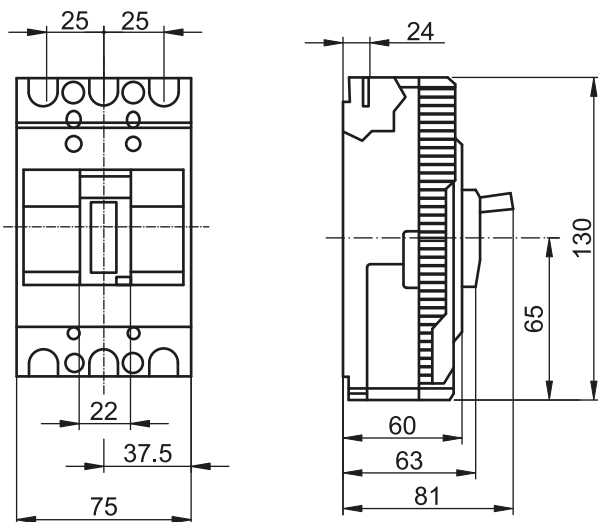

Méretrajz (MKM2)

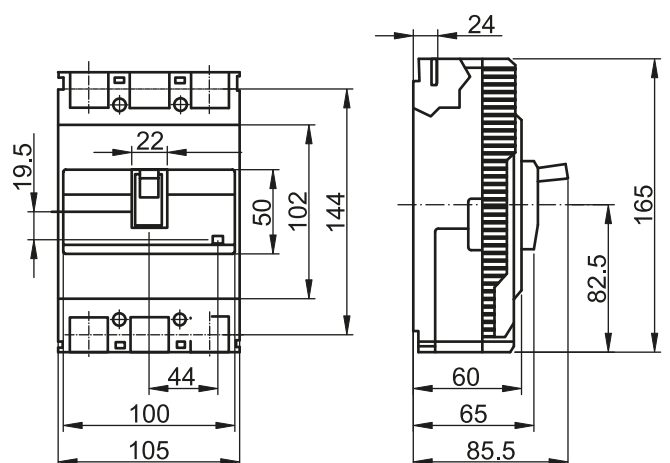

OLVASSA BE A KÓDOT!

- Nézze meg újdonságainkat
- Legyen naprakész

Kínálatunk gyorsan és folyamatosan fejlődik!
Katalógusunk a 2021. áprilisi állapotot tükrözi.

Naprakész információért
látogasson el honlapunkra!

Segédérintkező és hibajelző egységek

Tipus	Funkció
Segédérintkező egységek:	A kompakt megszakító főérintkezőinek állapotjelzése
Hibajelző érintkező egységek:	A kompakt megszakító zárlat, túlterhelés vagy működtetés általi kioldásának jelzése
Hibajelző / segédérintkező	A két fenti egység összeépítésével létrehozott érintkező egység révén kombinált vezérlési feladatok is megvalósíthatók

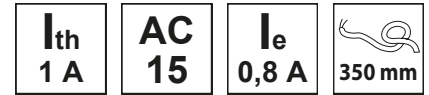

MKM-AX

TRACON	Funkció		
MKM-AX100	Segédérintkező	MKM1-..	0,25 mm ²
MKM-AX250	Segédérintkező	MKM2-..	0,35 mm ²
MKM-AL100	Hibajelző érintkező	MKM1-..	0,25 mm ²
MKM-AL250	Hibajelző érintkező	MKM2-..	0,35 mm ²
MKM-AXAL100	Hibajelző- és segédérintkező	MKM1-..	0,25 mm ²
MKM-AXAL250	Hibajelző- és segédérintkező	MKM2-..	0,35 mm ²

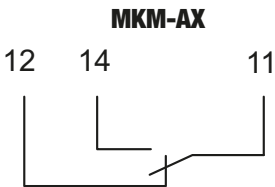

MKM-AX

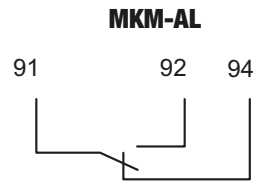

MKM-AL

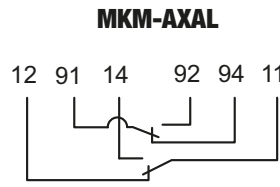

MKM-AXAL



MKM-AL



MKM-AXAL

Munkaáramú kioldó egységek

TRACON		P _{ON}	
MKM-SHT1-230	MKM1-..	<30 VA	0,25 mm ²
MKM-SHT2-230	MKM2-..		0,35 mm ²

Segítségével a kompakt megszakító távműködtetéssel kikapcsolható. Az SHT1-230 egység a megszakítók jobb és bal oldalába, míg az SHT2-230 egység a megszakítók jobb oldalába építhető be. Az egység a működtető feszültség értékének 0,7-szeresétől már kikapcsolja a megszakítót. A működtető feszültség időtartama max. 1s.

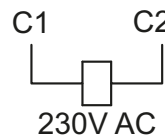

Felerősítő furatok

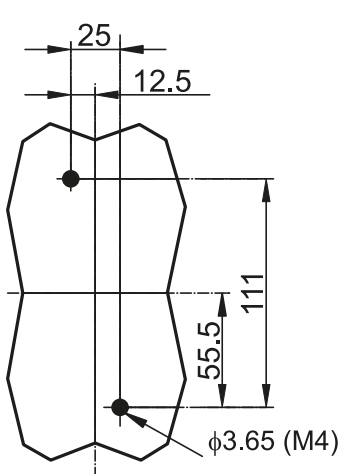

MKM1

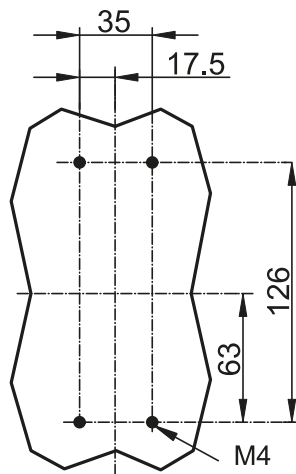

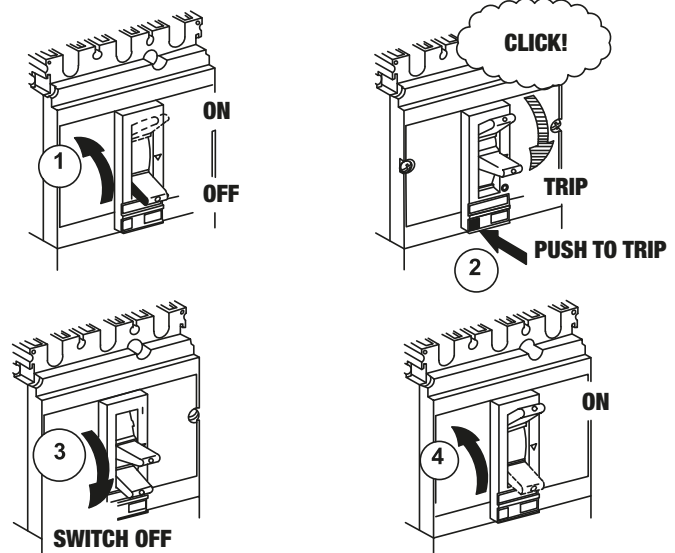

MKM2

A kapcsolókar helyzetei

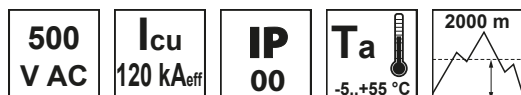

Késes biztosítók



	I_n	P_v
--	-------	-------

00C	6-160 A	7,5 W
00	2-160 A	12 W
0	6-160 A	16 W
1	32-250 A	23 W
2	50-400 A	34 W
3	160-630 A	48 W

Ház anyaga: szteatit
Olvadósál anyaga: réz

A késes biztosító túlterhelés vagy zárlat esetén - a létrejövő hő hatására történő kiolvadás útján - nyitja az áramkört, ezáltal a mögötte lévő vezeték részt és fogyasztókészülékeket megóvjva. Beépítésük és alkalmazásuk költségtakarékos annak ellenére, hogy minden kioldás után betétet kell cserélni. Teljesítőképességük a betétek cseréjével könnyen változtatható, semmilyen karbantartást nem igényel.

Az NT... biztosítóbetétek szabványos megjelölésénél a „gG” jelöli a teljes tartományú megszakító képességgel rendelkező, általános alkalmazásra szolgáló biztosítóbetéteket. Ez a jelölés a korábbi VDE szabvány szerinti „gL” jelölésnek felel meg. A motoráramkörök védelmére szolgáló rész tartományú megszakító képességgel rendelkező biztosítóbetéteket „aM” jelöléssel látják el.

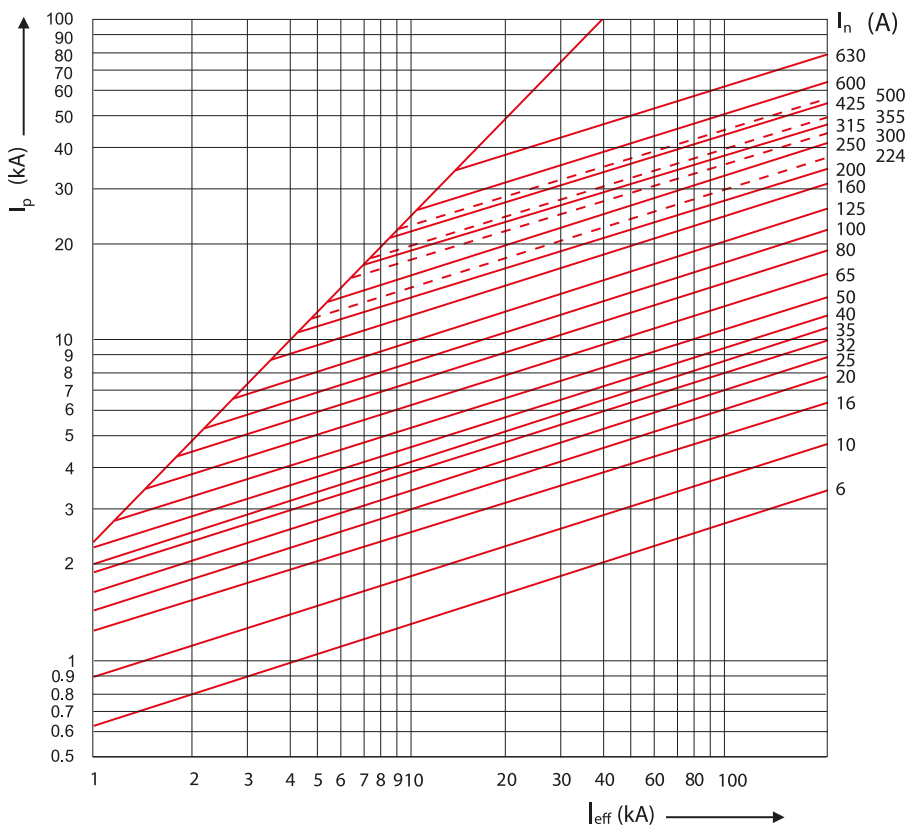

RELEVANT STANDARD
EN 60269-1
HD 60269-2

Az NT... típusú olvadóbiztosítók szavatolt áramkorlátozó hatását a fenti diagram mutatja. A koordináta rendszer vízszintes tengelyén a független zárlati áram effektív értéke (I_{eff}), a függőleges tengelyén pedig az áram csúcsértéke (I_p) látható.

Pl.: egy 100 A-es biztosító esetében, ha a független zárlati áram effektív értéke 20 kA, akkor a maximálisan kialakuló áramcsúcs kb. 11 kA lehet.

Típusválaszték

„00C” méret nagyságú biztosítók

TRACON		I _n
gG	aM	
NT00C-6	-	6 A
NT00C-10	-	10 A
NT00C-16	-	16 A
NT00C-20	-	20 A
NT00C-25	-	25 A
NT00C-32	-	32 A
NT00C-40	-	40 A
NT00C-50	-	50 A
NT00C-63	-	63 A
NT00C-80	-	80 A
NT00C-100	-	100 A
NT00C-125	-	125 A
NT00C-160	-	160 A

„00” méret nagyságú biztosítók

TRACON		I _n
gG	aM	
-	NTM00-2	2 A
NT00-4	NTM00-4	4 A
NT00-6	NTM00-6	6 A
NT00-10	NTM00-10	10 A
NT00-16	NTM00-16	16 A
NT00-20	NTM00-20	20 A
NT00-25	NTM00-25	25 A
NT00-32	NTM00-32	32 A
NT00-40	NTM00-40	40 A
NT00-50	NTM00-50	50 A
NT00-63	NTM00-63	63 A
NT00-80	NTM00-80	80 A
NT00-100	NTM00-100	100 A
NT00-125	NTM00-125	125 A
NT00-160	NTM00-160	160 A

„0” méret nagyságú biztosítók

TRACON		I _n
gG	aM	
NT0-6	NTM0-6	6 A
NT0-10	NTM0-10	10 A
NT0-16	NTM0-16	16 A
NT0-20	NTM0-20	20 A
NT0-25	NTM0-25	25 A
NT0-32	NTM0-32	32 A
NT0-40	NTM0-40	40 A
NT0-50	NTM0-50	50 A
NT0-63	NTM0-63	63 A
NT0-80	NTM0-80	80 A
NT0-100	NTM0-100	100 A
NT0-125	NTM0-125	125 A
NT0-160	NTM0-160	160 A

„1” méret nagyságú biztosítók

TRACON		I _n
gG	aM	
NT1-32	-	32 A
NT1-40	-	40 A
NT1-50	-	50 A
NT1-63	-	63 A
NT1-80	NTM1-80	80 A
NT1-100	NTM1-100	100 A
NT1-125	NTM1-125	125 A
NT1-160	NTM1-160	160 A
NT1-200	NTM1-200	200 A
NT1-224	-	224 A
NT1-250	NTM1-250	250 A

„2” méret nagyságú biztosítók

TRACON		I _n
gG	aM	
NT2-50	-	50 A
NT2-63	-	63 A
NT2-80	-	80 A
NT2-100	-	100 A
NT2-125	NTM2-125	125 A
NT2-160	NTM2-160	160 A
NT2-200	NTM2-200	200 A
NT2-224	NTM2-224	224 A
NT2-250	NTM2-250	250 A
-	NTM2-300	300 A
NT2-315	NTM2-315	315 A
NT2-355	NTM2-355	355 A
NT2-400	NTM2-400	400 A

„3” méret nagyságú biztosítók

TRACON		I _n
gG	aM	
NT3-160	-	160 A
NT3-200	-	200 A
NT3-315	NTM3-315	315 A
NT3-355	NTM3-355	355 A
NT3-400	NTM3-400	400 A
NT3-425	NTM3-425	425 A
NT3-500	NTM3-500	500 A
NT3-630	NTM3-630	630 A

RELEVANT STANDARD
EN 60269-1
HD 60269-2

Méretrajz

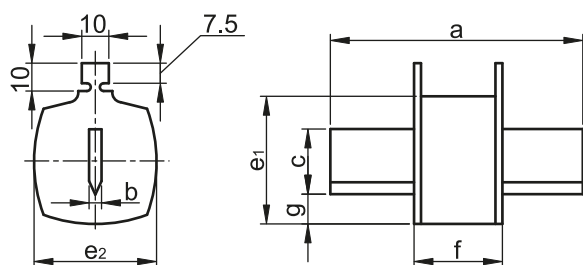

NT	a (mm)	f (mm)	g (mm)	c (mm)	e ₁ (mm)	e ₂ (mm)	b (mm)
00C	78±1.5	54-6	11.5	15	45	20	6
00	78±1.5	54-6	11.5	15	45	29	6
0	125±2.5	68-8	11.5	15	45	29	6
1	135±2.5	75-10	12	21	48	48	6
2	150±2.5	75-10	13	27	58	58	6
3	150±2.5	75-10	14	33	67	67	6

Biztosítóaljzatok

TRACON			A (mm)	B (mm)	C (mm)	D (mm)	E (mm)	F (mm)	G (mm)	H (mm)	K (mm)	M (mm)
	NTA-00C-00	00C, 00	120	100	25	8	30	25	60	56	–	8
	NTA-0	0	170	150	25	8	35	30	64	74	–	8
	NTA-1	1	200	175	25	12	49	32	85	80	30	10
	NTA-2	2	224	200	25	12	49	32	86	80	30	10
	NTA-3	3	235	210	25	12	49	32	88	80	30	12
	NTA-00/3	00C, 00	132	100	–	8	100	24	58	56,5	70	8

TRACON



NTA-00C-00 ... NTA-3:

magas hőállóságú, önkioltó műanyag alaptestre rögzített érintkező és csatlakozókapocs egységből állnak.

NTA-00/3:



NTA-00C-00, NTA-0



NTA-1, NTA-2



NTA-3



NTA-00/3

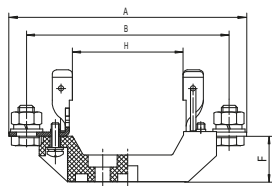

NTA-00C-00

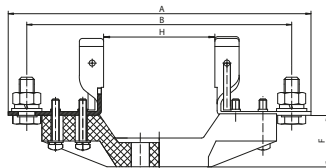
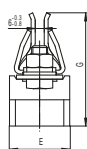

NTA-1

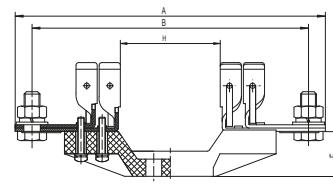
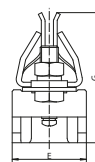

NTA-3

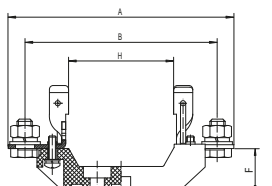
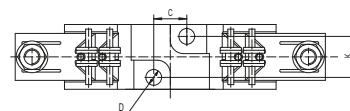
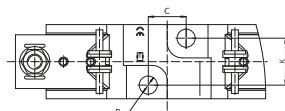
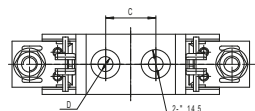
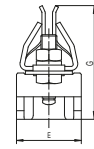

NTA-0

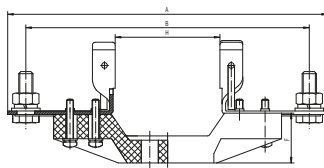
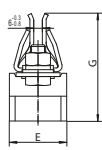

NTA-2

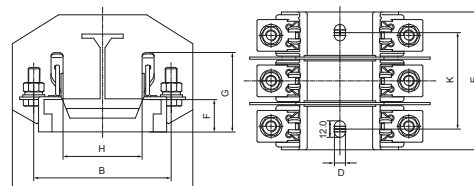
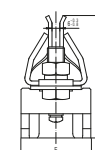

NTA-00/3

Rövidrezáró kések

TRACON		a (mm)	b (mm)	c (mm)	d (mm)
NTR00	00C, 00	45	15	45±1.5	78±1.5
NTR0	0	46	15	62±3	125±2.5
NTR1	1	51	20	62±3	135±2.5
NTR2	2	56	25	62±3	150±2.5
NTR3	3	62	32	65±3	150±2.5

A rövidrezáró kések elsősorban nullavezeték bontók kialakítására alkalmazhatóak.

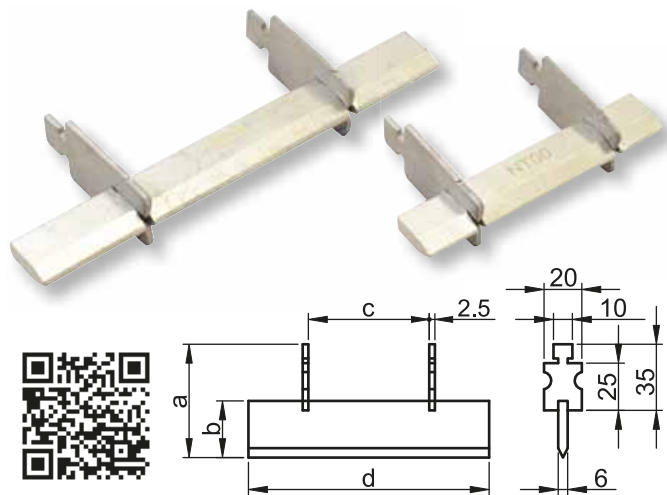

Kezelő fogó

TRACON		
NTK	1000 V	00C...3

A kezelő fogó alkalmazásával a késes biztosítóbetéteket – terhelésmentes állapotban – egyszerűen lehet az aljzatokba behelyezni és az aljzatokból eltávolítani. Így azok szakaszolóként is használhatók, mivel teljes biztonsággal és jól látható módon bontják az áramkört.

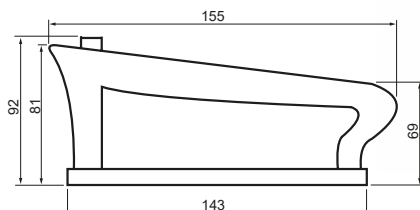
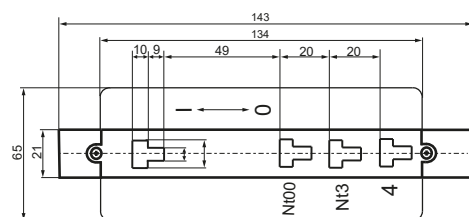

EDSS

ELOSZTÓDOBOZOK



H/4

Szakaszolókapcsoló-biztosító hengeres biztosítóhoz



230/400 V AC	IP 20	35×7.5	T _a -25...+55°C	U _i 690 V	V0 UL94	50/60 Hz	2000 m
-----------------	-----------------	--------	-------------------------------	-------------------------	------------	----------	--------



- Kétoldali betáplálás választás szerint fentről vagy lentől
- gG (normál) és aM (motor) jelleggörbéjű hengeres biztosítókhoz
- Szegecselts ház
- Többfázisú kivitelben
- Névleges zárlati megszakítóképesség AC 500 V; 100 kA
AC 690 V; 50 kA
- Ház anyaga: Önkioltó műanyag
- EN 60269 sorozat
- Maszkolható minden méret

RELEVANT STANDARD
EN60269-1

RELEVANT STANDARD
HD60269-2

TRACON	xP	I _n (A)	mm ²		
HBA-1P-20	1P	20 A	1,5-6	8 × 32 mm	
HBA-2P-20	2P	20 A	1,5-6	8 × 32 mm	
HBA-3P-20	3P	20 A	1,5-6	8 × 32 mm	
HBA-1P-32	1P	32 A	1,5-6	10 × 38 mm	
HBA-2P-32	2P	32 A	1,5-6	10 × 38 mm	
HBA-3P-32	3P	32 A	1,5-6	10 × 38 mm	
HBA-1P-50	1P	50 A	1,5-25	14 × 51 mm	
HBA-2P-50	2P	50 A	1,5-25	14 × 51 mm	
HBA-3P-50	3P	50 A	1,5-25	14 × 51 mm	
HBA-1P-100	1P	100 A	1,5-25	22 × 58 mm	
HBA-2P-100	2P	100 A	1,5-25	22 × 58 mm	
HBA-3P-100	3P	100 A	1,5-25	22 × 58 mm	

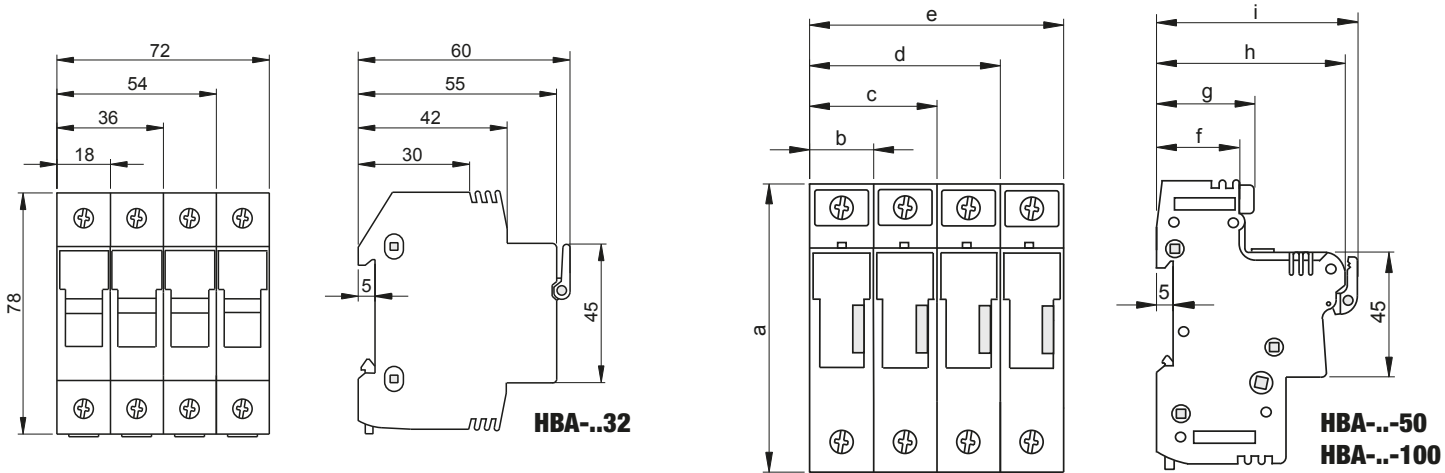
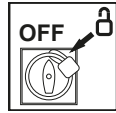

	a (mm)	b (mm)	c (mm)	d (mm)	e (mm)	f (mm)	g (mm)	h (mm)	i (mm)
HBA...-50	107	27	54	81	108	31	39	72.5	77.5
HBA...-100	113	35.5	71	106.5	142	31	39	72.5	77.5

Hengeres biztosító

8x32 mm

TRACON		I _n
gG	aM	
HB-8x32-2	HBM-8x32-2	2 A
HB-8x32-4	HBM-8x32-4	4 A
HB-8x32-6	HBM-8x32-6	6 A
HB-8x32-8	HBM-8x32-8	8 A
HB-8x32-10	HBM-8x32-10	10 A
HB-8x32-16	HBM-8x32-16	16 A

14x51 mm

TRACON		I _n
gG	aM	
HB-14x51-2	HBM-14x51-2	2 A
HB-14x51-4	HBM-14x51-4	4 A
HB-14x51-6	HBM-14x51-6	6 A
HB-14x51-8	HBM-14x51-8	8 A
HB-14x51-10	HBM-14x51-10	10 A
HB-14x51-16	HBM-14x51-16	16 A
HB-14x51-20	HBM-14x51-20	20 A
HB-14x51-25	HBM-14x51-25	25 A
HB-14x51-32	HBM-14x51-32	32 A
HB-14x51-40	HBM-14x51-40	40 A
HB-14x51-50	HBM-14x51-50	50 A

	D (mm)	L (mm)
8x32	8,5	31,5
10x38	10,3	38
14x51	14,3	51
22x58	22,2	58

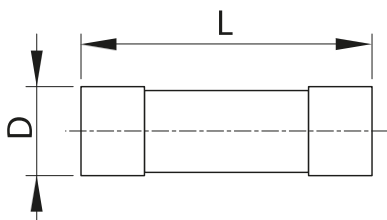

RELEVANT STANDARD
EN 60269-1

RELEVANT STANDARD
HD 60269-2

10x38 mm

TRACON		I _n
gG	aM	
HB-10x38-1	HBM-10x38-1	1 A
HB-10x38-2	HBM-10x38-2	2 A
HB-10x38-4	HBM-10x38-4	4 A
HB-10x38-6	HBM-10x38-6	6 A
HB-10x38-8	HBM-10x38-8	8 A
HB-10x38-10	HBM-10x38-10	10 A
HB-10x38-16	HBM-10x38-16	16 A
HB-10x38-20	HBM-10x38-20	20 A
HB-10x38-25	HBM-10x38-25	25 A
HB-10x38-32	HBM-10x38-32	32 A

22x58 mm

TRACON		I _n
gG	aM	
HB-22x58-10	HBM-22x58-10	10 A
HB-22x58-16	HBM-22x58-16	16 A
HB-22x58-20	HBM-22x58-20	20 A
HB-22x58-25	HBM-22x58-25	25 A
HB-22x58-32	HBM-22x58-32	32 A
HB-22x58-40	HBM-22x58-40	40 A
HB-22x58-50	HBM-22x58-50	50 A
HB-22x58-63	HBM-22x58-63	63 A
HB-22x58-80	HBM-22x58-80	80 A
HB-22x58-100	HBM-22x58-100	100 A



OLVASSA BE A KÓDOT!

- Nézze meg újdonságainkat
- Legyen naprakész

Kínálatunk gyorsan és folyamatosan fejlődik!
Katalógusunk a 2021. áprilisi állapotot tükrözi.
Naprakész információért
látogasson el honlapunkra!

Vízszintes szakaszolókapcsoló-biztosítók szerelőlapra

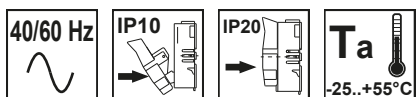

A Jean Müller gyártmányú KETO késes biztosítós szakaszolókapcsolók és a COSMO® gyűjtősínrendszerek, valamint ezek kiegészítő eszközeinek részletes műszaki adatait és méreteit megtalálja a TRACON kivonat katalógusában vagy a TRACON Webáruházban. A késes biztosítós szakaszolókapcsolók méreteit, részletes műszaki adatait a www.traconelectric.com honlapon találja!

- csavaros (A) vagy szorítókapcsos (B) csatlakozás
- 1-, 2-, 3-, 4-pólusú kivitel
- 4 méret nagyság, 00, 1, 2 és 3 méretű késes biztosítókhoz
- Utólag is felszerelhető, univerzális csatlakozási módok
- Vízszintes beépítés esetén redukciós faktor: 0,8

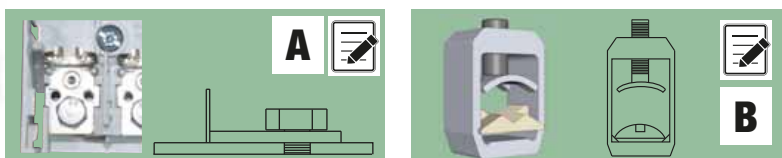

TRACON	I_n			mm ²	L (mm)	W (mm)	H (mm)	U_i	U_e
KETO-00-1/F	160	00		max. 95, M10	204	50	84	800 VAC	690 VAC, 440 VDC
KETO-00-1/R95				1,5-95	204	50	84	800 VAC	690 VAC, 440 VDC
KETO-1-1/F	250	1		max. 150, M10	306	69	117	800 VAC	690 VAC, 440 VDC
KETO-3-1/F				max. 300, M10	306	91	143	800 VAC	690 VAC, 440 VDC
KETO-00-3/F	160 A	00		max. 95, 1×M8/2×M5	204	106	84	800 VAC	690 VAC, 440 VDC
KETO-00-3/R95				1,5-95	204	106	84	800 VAC	690 VAC, 440 VDC
KETO-1-3/F	250 A	1		max. 150, M10	306	184	117	800 VAC	690 VAC, 440 VDC
KETO-1-3/R150				35-150	306	184	117	800 VAC	690 VAC, 440 VDC
KETO-2-3/F	400 A	2		max. 240, M10	306	210	117	800 VAC	690 VAC, 440 VDC
KETO-2-3/R300				95-300	306	210	117	800 VAC	690 VAC, 440 VDC
KETO-3-3/F	630 A	3		max. 300, M10	306	250	117	800 VAC	690 VAC, 440 VDC
KETO-3-3/R300				95-300	306	250	117	800 VAC	690 VAC, 440 VDC

KERESSE KETO KATALÓGUSUNKAT ÜGYFÉLSZOLGÁLATUNKON VAGY KÉRJE ÜZLETKÖTŐJÉTŐL!



TELJES TÍPUSVÁLASZTÉK!

- Csatlakozó kapcsok
- Sorolósínek 00
- Érintésvédelmi burkolatok
- Kalapsín adapterek, 00-1
- Lakatoló elemek, 00-3
- Állásjelzők
- Biztosító felügyelet
- Áramlopás védelem
- Műszaki adatok
- Méretrajzok

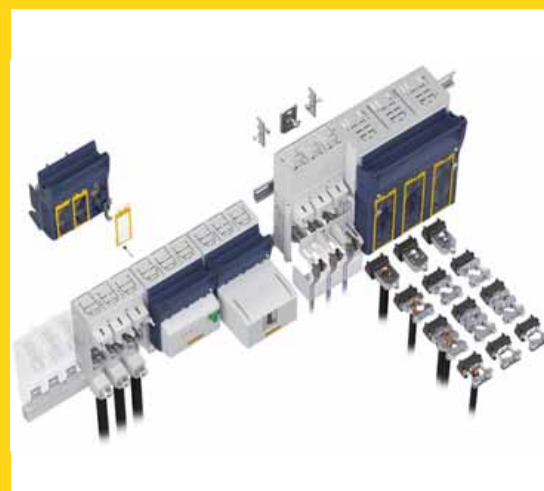

Vízszintes szakaszolókapcsoló-biztosítók, gyűjtősínre szerelhető kivitel

A már kiépített, 60 és 100 mm sínközéptávolságú, hárompólusú gyűjtősínrendszerhez utólagosan is könnyedén felszerelhetők. A sínek mögött elhelyezett rögzítőelemek a készülék hátlapján található csatlakozási áramvezető felületet a gyűjtősínhez szorítják, ezzel biztosítva az üzembiztos rögzítést felül a szakaszoló betáplálását is.

- 3 pólusú, gyűjtősínes/csavaros/szorítókapcsos csatlakozás
- 60 mm-es és 100 mm-es sínközéptávolság
- 5-10 mm-es sínvastagság
- 00, 1, 2 és 3 méretnagyságú késes biztosítókhoz



TRACON		I_n		$a \times b$		mm ²	L (mm)	W (mm)	H (mm)	
KETO-00-3/60/A0U/F		60 mm	160 A	00	20-30 × 5-10		max. 95, 1×M8/2×M5	204	106	109
KETO-00-3/60/A0U/R95		60 mm	160 A	00	20-30 × 5-10		1,5-95	204	106	109
KETO-00-3/60/A0U/R95T*		60 mm	160 A	00	20-30 × 5-10		1,5-95	204	106	109
KETO-1-3/60/A0U/F		60 mm	250 A	1	20-30 × 5-10		max. 150, M10	306	184	117
KETO-1-3/60/A0U/R150		60 mm	250 A	1	20-30 × 5-10		35-150	306	184	117
KETO-2-3/60/A0U/F		60 mm	400 A	2	20-30 × 5-10		max. 240, M10	306	210	135
KETO-2-3/60/A0U/R300		60 mm	400 A	2	20-30 × 5-10		95-300	306	210	135
KETO-3-3/60/A0U/F		60 mm	630 A	3	20-30 × 5-10		max. 300, M10	306	250	143
KETO-3-3/60/A0U/R300		60 mm	630 A	3	20-30 × 5-10		95-300	306	250	143
KETO-1-3/100/A0U/F		100 mm	250 A	1	20-50 × 5-10		max. 150, M10	306	184	146
KETO-2-3/100/A0U/F		100 mm	400 A	2	20-50 × 5-10		max. 240, M10	306	210	144
KETO-3-3/100/A0U/F		100 mm	630 A	3	20-50 × 5-10		max. 300, M10	306	250	152

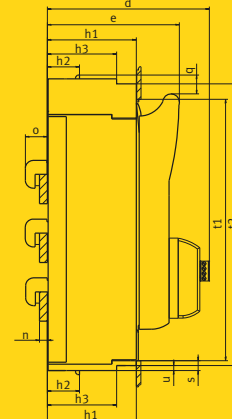
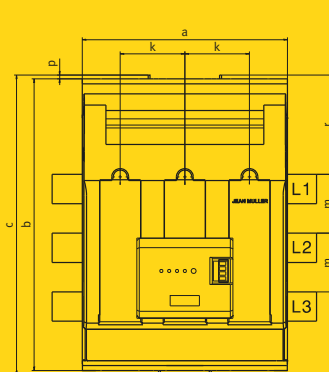

A Jean Müller cég 1897 óta meghatározó szerepet tölt be az erőáramú kapcsolókészülékek piacán. Megbízható, jó minőségű termékeik az egész világon elismertek, ezt a minőséget most Ön is megtapasztalhatja.

Függőleges szakaszolókapcsoló-biztosítók 185 mm sínközéptávolságú gyűjtősínrendszerhez

500/690
V AC220/400
V DC40/60 Hz
 U_i
1 kVIP10
IP20
T_a
-25..+55°C











Piktogramok

I/O











Főbb jellemzők

A felső vagy alsó kábelcsatlakozást a készülék 180 fokos megfordításával lehet megválasztani. Feszültségmérés céljára kialakított vizsgálófuratok a kapcsolófedélben.

Pólusonként szakaszolható kivitel

TRACON	I _n		 mm ²	L (mm)	W (mm)	H (mm)	
SL00-3X/185/F	160 A	00	Max. 95	662	50	135,5	
SL00-3X/185/KU00	160 A	00	10 – 95	662	50	135,5	
SL1-3X/3A	250 A	1	25 – 150	762	99	194	
SL1-3X/9/KM2G-F	250 A	1	25 – 240	762	99	194	
SL2-3X/3A	400 A	2	25 – 240	762	99	194	
SL2-3X/9/KM2G-F	400 A	2	25 – 240	762	99	194	
SL3-3X/3A	630 A	3	25 – 300	762	99	194	
SL3-3X/9/KM2G-F	630 A	3	25 – 240	762	99	194	

Egyszerre három pólusban szakaszolható kivitel

TRACON	I _n		 mm ²	L (mm)	W (mm)	H (mm)	
SL00-3X3/185/F	160 A	00	Max. 95	662	50	150	
SL00-3X3/185/KU00	160 A	00	10 – 95	662	50	150	
SL1-3X3/3A	250 A	1	25 – 150	762	99	202	
SL1-3X3/9/KM2G-F	250 A	1	25 – 240	762	99	202	
SL2-3X3/3A	400 A	2	25 – 240	762	99	202	
SL2-3X3/9/KM2G-F	400 A	2	25 – 240	762	99	202	
SL3-3X3/3A	630 A	3	25 – 300	762	99	202	
SL3-3X3/9/KM2G-F	630 A	3	25 – 240	762	99	202	

Kapcsolókar

- Hosszú kapcsolókar a biztonságos és gyors kapcsoláshoz
- Bármelyik pólus lakatolható BE vagy KI állásban is (pólusonként szakaszolható kivitel esetében)

Mérés és ellenőrzés

- Biztonságos feszültségmérés a vizsgálófuratokon keresztül a biztosítóaljzat érintkezőjéről

Szerelés

- Biztonságos szerelés feszültség alatt is a véletlen érintés ellen kialakított érintkező védőburkolatnak köszönhetően
- Felcserélhető rögzítőfülek a gyűjtősínre való rögzítéshez



100 és 185 mm sínközéptávolságú gyűjtősínrendszerek kiépítéséhez használható kiegészítők

SH100/185

Gyűjtősínrögzítő (100 és 185 mm sínközéptávolságú rendszerekhez)



A gyűjtősínartó alkalmas 100 és 185 mm-es sínközéptávolságú gyűjtősínek rögzítésére, segítségükkel optimális gyűjtősínrendszer alakítható ki a függőleges biztosítós szakaszolókapcsolók számára is. A külön rendelhető sínartó elemekkel kiegészítve egy érintésvédelmileg teljesen védett sínrendszer hozható létre.

Műszaki adatok:

- Pólusszám: 3
- Rögzítő csavar mérete: M12
- Gyűjtősín szélesség: 100 mm
- Sínközéptávolság: 100 ill. 185 mm
- Befoglaló méret: 38×442×25 mm (szélesség × magasság × vastagság)

H-SL123/662

Gyűjtősínartó, csavaros (185 mm sínközéptávolságú rendszerekhez)



A függőleges, mellső gyűjtősínartó segítségével a 185 mm sínközéptávolságú, 3 fázisú gyűjtősínrendszer sínjeinek érintésvédelmi szempontból nem védett részeinek mellső, kezelőoldal felőli elszigetelése valósítható meg.

Műszaki adatok:

- Pólusszám: 3
- Rögzítő csavarok: műanyag, rögzítőfüllel
- Gyűjtősín szélesség: 100 mm
- Sínközéptávolság: 185 mm
- Befoglaló méret: 100×662×2 mm (szélesség × magasság × vastagság)

H-RF

Gyűjtősínartó, pattintható (100 és 185 mm sínközéptávolságú rendszerekhez)



A csavaros gyűjtősínartóval egyező funkcióval rendelkezik, csak a szerelés módja eltérő. A takaró a gyűjtősínre egyszerűen felpattintható.

A szereléshez szerszám használata nem szükséges.

Műszaki adatok:

- Pólusszám: 3
- Rögzítő csavarok: műanyag, rögzítőfüllel
- Gyűjtősín szélesség: 100 mm
- Sínközéptávolság: 100 ill. 185 mm
- Befoglaló méret: 99×572×36 mm (szélesség × magasság × vastagság)

HW-SH/185

Gyűjtősínartó oldalsó burkolat (185 mm sínközéptávolság)



Segítségével az SH100/185 típusú gyűjtősínartó oldalának elszigetelése valósítható meg. Az oldalsó burkolat és a csavaros vagy pattintható mellső sínartóval kiegészítve az SH100/185 sínartóval szerelt 185 mm széles gyűjtősínrendszerek a kezelőoldal felől teljesen burkolttá tehetők.

Műszaki adatok:

- Pólusszám: 3
- Rögzítő csavarok: műanyag, rögzítőfüllel
- Sínközéptávolság: 185 mm
- Befoglaló méret: 25×442×38 mm (szélesség × magasság × vastagság)

Függőleges 185 mm sínközéptávolságú szakaszolókapcsoló-biztosítókhoz használható kiegészítők



AL-SL00/42

Adapter 00, 00C méretnagyságú készülékek kiemelésére

Segítségével a 00, 00C méretű készülék kiemelhető a síkból, így az 1-2-3-as méretnagyságú készülékekkel azonos magasságba kerül. Ezzel az elosztószekrény belső szerkezete esztétikusabbá, a beépített készülékek kezelése egyszerűbbé válik.

Műszaki adatok:

- Pólusszám: 3
- Készülék mérete: 00, 00C
- Rögzítő csavar mérete: M12
- Gyűjtősín szélesség: 100 mm
- Sínközéptávolság: 185 mm
- Befoglaló méret: 99×450×42 mm (szélesség × magasság × vastagság)



SK-L/SL00/15

Gyűjtősínkapocs 00, 00C méretnagyságú készülékekhez

SK-L/SL123/10

Gyűjtősínkapocs SL00, 1, 2, 3 méretnagyságú készülékekhez

Segítségükkel gyorsabban lehet az SL00, 00C, 1, 2, 3 méretnagyságú készülékeket a gyűjtősínre rögzíteni.

Műszaki adatok:

- Anyag: ózozott réz
- Készülék mérete: 00, 00C, 1, 2, 3
- Rögzítő csavar mérete: M12
- Sín vastagság: 5-10 mm



COSMO 60 mm-es gyűjtősínrendszer



Komplett megoldás 60 mm sínközéptávolságú gyűjtősínrendszer kiépítéséhez, a lenti elemek használatával.

Főbb jellemzők

- Széles körű felhasználás
- Rövid installációs idő
- Kevesebb huzalozás
- Könnyű szerelhetőség
- Egységesített méretek



Gyűjtősíntartók és burkolataik (60 mm sínközéptávolság)



TRACON	Kivitel
SST-60/1	Gyűjtősíntartó, 1p
SST-60/3	Gyűjtősíntartó, 3p
SST-60/4	Gyűjtősíntartó, 4p
A-SST-60/3	Oldalsó burkolat 3 pólusú gyűjtősínhez
A-SST-60/4	Oldalsó burkolat 4 pólusú gyűjtősínhez
SAD60/3	Mellső burkolat 3 pólusú gyűjtősínhez
SAD60/4	Mellső burkolat 4 pólusú gyűjtősínhez

A síntartók két részből álló, szigetelőanyagból készített egységek, beépített távtartóval, 5 és 10 mm vastagságú, 20-30 mm szélességű gyűjtősínre beépítéséhez. A burkolatok mindhárom fázist lefedik és minimális erővel a sínre pattinthatók. Egymást átfedve is mozgathatók, így könnyen változtatható szélességű burkolatot eredményez vágás nélkül.

Leágazó modulok (60 mm sínközéptávolság)

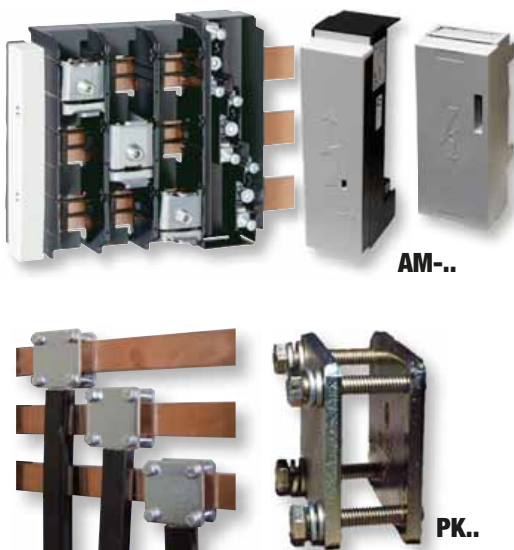

TRACON	Kivitel, leágazás (szélesség x vastagság)
AM-60/250/3	250 A-ig, 1,5 mm ² - 70 mm ²
AM-60/250/3/120-5	250 A-ig, 16 mm ² -120 mm ² , 5 mm vastag sínhez
AM-60/250/3/120-10	250 A-ig, 16 mm ² -120 mm ² , 10 mm vastag sínhez
AM-60/630/3	630 A-ig, 70 mm ² -300 mm ² , 5/10 mm vastag sínhez
PK30/34X10	30 mm széles sínre, 34×10 mm-es lemezsínhez
PK40/34X10	40 mm széles sínre, 34×10 mm-es lemezsínhez
PK50/34X10	50 mm széles sínre, 34×10 mm-es lemezsínhez
PK50/54X10	50 mm széles sínre, 54×10 mm-es lemezsínhez
PK60/34X10	60 mm széles sínre, 34×10 mm-es lemezsínhez
PK60/54X10	60 mm széles sínre, 54×10 mm-es lemezsínhez





Alkalmasak a gyűjtősínre betáplálására és a kábelek leágaztatására is. Az AM... modulok az érintésvédelmi burkolatot is tartalmazzák, kábelek gyűjtősínre történő leágaztatására használhatók. A PK... modulok burkolat nélküli kivitelek, amelyek szorítócsavarjai a leágazás gyűjtősínjét a fősínhez szorítják.

Leágazó kapcsok



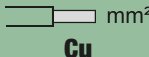

TRACON		
5 mm	10 mm	mm ²
LAK5/1,5-16	LAK10/1,5-16	1,5-16 mm ²
LAK5/1,5-35	LAK10/1,5-35	1,5-35 mm ²
LAK5/1,5-50	LAK10/1,5-50	1,5-50 mm ²
LAK5/16-70	LAK10/16-70	16-70 mm ²
LAK5/16-120	LAK10/16-120	16-120 mm ²
LAK5/16-185	LAK10/16-185	16-185 mm ²

Szorítócsatlakozó

TRACON	 mm ² Cu	 a x b a x b	X 	
S00	6-50	9x5 mm, Cu	2 x M5	00 KETO, SL..
S1	25-150	18x10 mm, Cu	2 x M6	1 KETO
S2	25-240	19x10 mm, Cu	2 x M8	2 KETO
S3	–	21x15 mm, Cu	2 x M8	3 KETO



Prizma-kapocs

TRACON	 mm ² Cu/Al	X 	
P0070	1x10 - 70	2 x M5	00 KETO, SL..
P0095	1x10 - 95	2 x M5	1 KETO, SL..
P1	1x70 - 150	2 x M6	1 KETO
P2	1x120 - 240	2 x M8	2 KETO
P3	1x120 - 300	2 x M8	3 KETO
P12	2x70 - 95	2 x M6	1 KETO
P22	2x120 - 150	2 x M8	2 KETO
P32	2x120 - 240	2 x M8	3 KETO





P..



P..2

V-szorítókapocs

TRACON	 mm ² Cu/Al	 a x b a x b	
KM2G-F	25-240 mm ² Cu/Al	–	1, 2, 3 L/SL..
KM2G	25-300 mm ² Cu/Al	–	1, 2, 3 L/SL..
KM2G-F/A30-40	25-240 mm ² Cu/Al	30-40 mm	1, 2, 3 L/SL..
KM2G/A30-40	25-300 mm ² Cu/Al	30-40 mm	1, 2, 3 L/SL..





KM2G../A30-40



KM2G..

U-szorítókapocs

TRACON	 mm ² Cu/Al	 a x b a x b	
KU00/1/2X/A30-40*	2x10-95 mm ² Cu/Al	30-40 mm	00 L/SL..
KU00	10-95 mm ² Cu/Al	–	00 L/SL..
KU00/2	1x95/2x50 mm ² Cu/AL	–	00 L/SL..

* Csatlakozófüllel ellátott kivitel, sínre szerelhető



KU00/1/2x30-40



KU00

Minden Jean Müller szakaszolókapcsoló speciálisan kialakított késérintkezővel van ellátva a villamosenergia-rendszer megbízható, üzembiztos működése érdekében.

Az érintkező kialakítása az optimális ívterelés segítségével megrövidíti a villamos ívelés időtartamát, és ezzel csökkenti az érintkező felület erodálódását.

Az érintkező közepének egyenes felülete a megfelelő érintkező felületet biztosítja a teljesítményvesztés alacsony tartása érdekében. Az érintkező aljának kialakítása pedig a rövidzáras alatt történő kapcsolás során fellépő érintkező behégedés ellen védi a készüléket, így a szakaszolókapcsoló névleges zárlati megszakítóképessége akár 110 kA is lehet!



Ipari kézikapcsolók



U_i
690 V

50/60 Hz

U_{imp}
6 kV

T_a
-5...+55 °C



		TK-20	TK-25	TK-32	TK-63	TK-125	TK-160	
I_{th} (A)		20	25	32	63	125	160	
P_e (kW)	400 V~	AC-23A	7,5	11	15	30	45	75
		AC-2	7,5	11	15	30	45	55
		AC-3	5,5	7,5	11	18,5	30	37
		AC-4	1,5	3	5,5	7,5	12	15
I_e (A)	400 V~	AC-21A	20	25	32	63	100	150
		AC-22A	20	25	32	63	100	150
		AC-23A	15	22	30	37	90	135
		AC-2	15	22	30	37	90	135
		AC-3	11	15	22	36	75	95
		AC-4	3,5	6,5	11	15	30	55
		AC-15	4	5	6	-	-	-
	240 V =	DC-13	1	1,5	4	-	-	
⚡ (×10 ⁵)		5	5	3	1,5	1,5	1,5	
⚡ (×10 ⁵)		3	3	1,2	1	1	1	
ON-OFF-ON... sc/h		200	150	100	60	30	30	
mm ²		1×2,5	1×4,0	1×6,0	1×25	1×50	1×70	
		2×1,5	2×1,5	2×4,0	2×10	2×25	2×35	
		1×2,5	1×4,0	1×4,0	1×16	1×35	1×50	
		2×1,5	2×1,5	2×2,5	2×6	2×10	2×16	
I_{cw} (1s, A)		200	250	400	600	600	800	
I_{cw} (A)		20	25	32	63	125	160	

Méretrajzok és felerősítési furatok

TK..., TKV..., TKB..., TKM..., TKU..., TKI-F

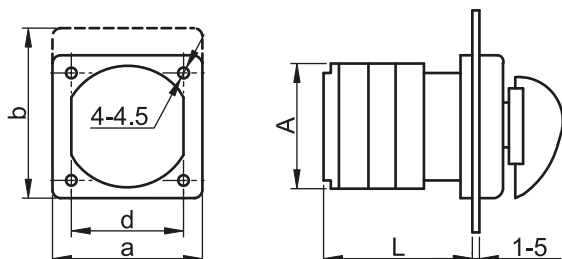

TKF..., TKFL...

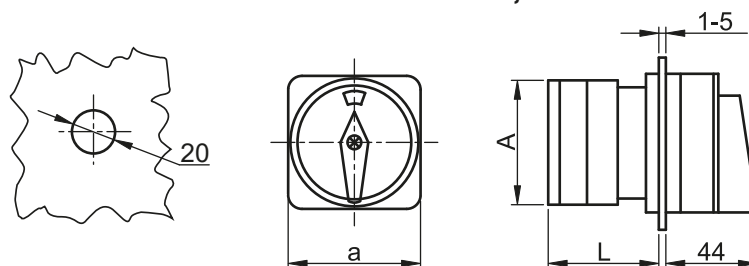

Méreteket lásd a választéktáblázatban! (I/22-I/27.)



OLVASSA BE A KÓDOT!

- Nézze meg újdonságainkat
- Legyen naprakész

Kínálatunk gyorsan és folyamatosan fejlődik!
Katalógusunk a 2021. áprilisi állapotot tükrözi.
Naprakész információért
látogasson el honlapunkra!

Tokozatok

TRACON		D (mm)	W (mm)	H (mm)	a×b (mm)	C (mm)	d (mm)		IP..
TK/T1+F1/		68	68	64	48 × 48	25	9,5	2 × MG-20	IP 44
TK/T2+F1/		68	68	72	48 × 48	25	9,5	2 × MG-20	IP 44
TK/T2+F2/		68	68	80	48 × 48	32	22	2 × MG-20	IP 44
TK/T3+F3/		112	112	108	64 × 64	35	11,5	2 × MG-25 2 × MG-32	IP 44
TK/T3+F3S/		112	112	108	64 × 64	35	11,5	2 × MG-25 2 × MG-32	IP 44
TKTS-01		110	83	69	48 × 48/ 64 × 64	22	9,5	2 × (2 × MG-20)	IP 65
TKTS-02		120	113	87	48 × 48/ 64 × 64	25	9,5	2 × (2 × MG-25)	IP 65
TKTS-03		200	140	109	64 × 64/ 88 × 88	30	11,5	2 × MG-25 2 × MG-32	IP 65

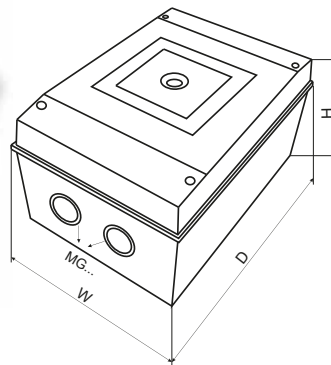
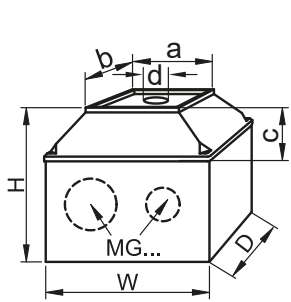

RELEVANT STANDARD
EN 60947-3

Tömítőkészletek

TRACON	
TKT-65	TK-20.., TK-25.., TKV-20.., TKV-25.., TKB-20.., TKB-25.., TKM-20.., TKM-25.., TKF-20.., TKF-25..
TKT-65/2	TK-32.., TK-63.., TKV-32.., TKV-63.., TKB-32.., TKB-63.., TKM-32.., TKM-63.., TKF-32.., TKF-63..
TKT-65/3	TKFL-..
TKT-65/4	TKFK-..



IP
65

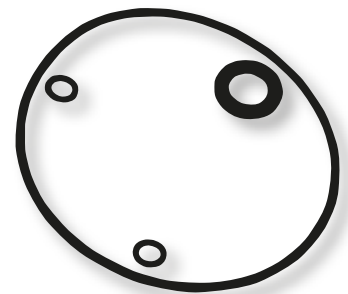

Adapter

TRACON	
TKA	TK-20.., TK-25.., TKV-20.., TKV-25.., TKB-20.., TKB-25.., TKM-20.., TKM-25.., TKF-20.., TKF-25..



RELEVANT STANDARD
EN 60947-3

TRACON

IP 42



+



+



Általános BE-KI kapcsolók

TK-206/2	TK-206/2T	TK-206/2T65	20 A / 2P	TK/T1+F1/
TK-256/2	TK-256/2T	TK-256/2T65	25 A / 2P	TK/T1+F1/
TK-209/2	TK-209/2T	TK-209/2T65	20 A / 2P	TK/T1+F1/
TK-259/2	TK-259/2T	TK-259/2T65	25 A / 2P	TK/T1+F1/
TK-206/3	TK-206/3T	TK-206/3T65	20 A / 3P	TK/T1+F1/
TK-256/3	TK-256/3T	TK-256/3T65	25 A / 3P	TK/T2+F1/
TK-326/3	TK-326/3T	TK-326/3T65	32 A / 3P	TK/T3+F3/
TK-636/3	TK-636/3T	TK-636/3T65	63 A / 3P	TK/T3+F3/
TK-126/3	-	TK-126/3T65	125 A / 3P	TKTS-03
TK-166/3	-	TK-166/3T65	160 A / 3P	TKTS-03
TK-209/3	TK-209/3T	TK-209/3T65	20 A / 3P	TK/T1+F1/
TK-259/3	TK-259/3T	TK-259/3T65	25 A / 3P	TK/T2+F1/
TK-329/3	TK-329/3T	TK-329/3T65	32 A / 3P	TK/T3+F3/
TK-639/3	TK-639/3T	TK-639/3T65	63 A / 3P	TK/T3+F3/
TK-129/3	-	TK-129/3T65	125 A / 3P	TKTS-03
TK-169/3	-	TK-169/3T65	160 A / 3P	TKTS-03
TK-206/4	TK-206/4T	TK-206/4T65	20 A / 4P	TK/T1+F1/
TK-256/4	TK-256/4T	TK-256/4T65	25 A / 4P	TK/T2+F1/
TK-326/4	TK-326/4T	TK-326/4T65	32 A / 4P	TK/T3+F3/
TK-636/4	TK-636/4T	TK-636/4T65	63 A / 4P	TK/T3+F3/
TK-126/4	-	TK-126/4T65	125 A / 4P	TKTS-03
TK-166/4	-	TK-166/4T65	160 A / 4P	TKTS-03
TK-209/4	TK-209/4T	TK-209/4T65	20 A / 4P	TK/T1+F1/
TK-259/4	TK-259/4T	TK-259/4T65	25 A / 4P	TK/T2+F1/
TK-329/4	TK-329/4T	TK-329/4T65	32 A / 4P	TK/T3+F3/
TK-639/4	TK-639/4T	TK-639/4T65	63 A / 4P	TK/T3+F3/
TK-129/4	-	TK-129/4T65	125 A / 4P	TKTS-03
TK-169/4	-	TK-169/4T65	160 A / 4P	TKTS-03

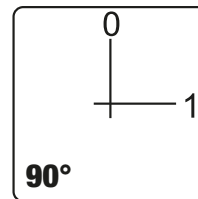
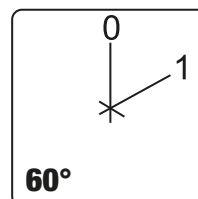
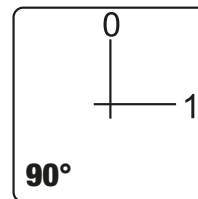
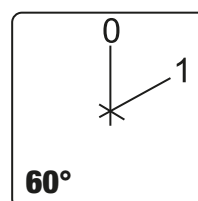
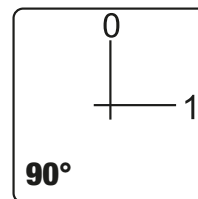
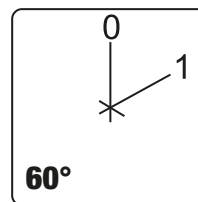

Választókapcsolók

TKV-206/3	TKV-206/3T	TKV-206/3T65	20 A / 2×3P	TK/T2+F1/
TKV-256/3	-	TKV-256/3T65	25 A / 2×3P	TKTS-02
TKV-326/3	TKV-326/3T	TKV-326/3T65	32 A / 2×3P	TK/T3+F3/
TKV-636/3	-	TKV-636/3T65	63 A / 2×3P	TKTS-03
TKV-126/3	-	-	125 A / 2×3P	-
TKV-166/3	-	-	160 A / 2×3P	-
TKV-206/4	-	TKV-206/4T65	20 A / 2×4P	TKTS-01
TKV-256/4	-	TKV-256/4T65	25 A / 2×4P	TKTS-02
TKV-326/4	TKV-326/4T	TKV-326/4T65	32 A / 2×4P	TK/T3+F3/
TKV-636/4	-	-	63 A / 2×4P	-
TKV-126/4	-	-	125 A / 2×4P	-
TKV-166/4	-	-	160 A / 2×4P	-

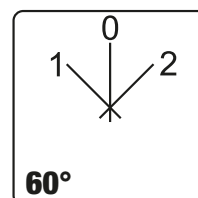
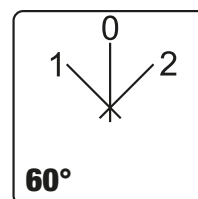

					L	A	a	b	d				
0°	60°				(mm)	(mm)	(mm)	(mm)	(mm)				
1-2	×												
3-4	×												
					28	43,5	48	48	36				
					28	43,5	48	48	36				
0°	90°												
1-2	×												
3-4	×												
					33	45,3	48	48	36				
					33	45,3	48	48	36				
0°	60°												
1-2	×				41,2	43	48	48	36				
3-4	×				48,6	45,2	48	48	36				
5-6	×				54,8	58	64	64	48				
					72,2	66	64	64	48				
					84	84	88	88	68				
					97	88	88	88	68				
0°	90°												
1-2	×				41,2	43	48	48	36				
3-4	×				48,6	45,2	48	48	36				
5-6	×				54,8	58	64	64	48				
					72,2	66	64	64	48				
					84	84	88	88	68				
					97	88	88	88	68				
0°	60°												
1-2	×				41,2	43	48	48	36				
3-4	×				48,6	45,2	48	48	36				
5-6	×				54,8	58	64	64	48				
					72,2	66	64	64	48				
					84	84	88	88	68				
					97	88	88	88	68				
0°	90°												
1-2	×				41,2	43	48	48	36				
3-4	×				48,6	45,2	48	48	36				
5-6	×				54,8	58	64	64	48				
7-8	×				72,2	66	64	64	48				
					84	84	88	88	68				
					97	88	88	88	68				
-60°	0°	60°											
1-2	×					50,8	43	48	48	36			
3-4		×				61,4	45,2	48	48	36			
5-6	×					67,6	58	64	64	48			
7-8			×			93,7	66	64	64	48			
9-10	×					110	84	88	88	68			
11-12			×			130	88	88	88	68			
-60°	0°	60°	-60°	0°	60°								
1-2	×		9-10	×		60,4	43	48	48	36			
3-4		×	11-12		×	74,2	45,2	48	48	36			
5-6	×		13-14	×		80,4	58	64	64	48			
7-8		×	15-16		×	115,2	66	64	64	48			
						136	84	88	88	68			
						163	88	88	88	68			



TRACON

IP 42



+



+











Választókapcsolók

TKV-209/3	TKV-209/3T	TKV-209/3T65	20 A / 2×3P	TK/T2+F1/	<p>90°</p>	
TKV-259/3	-	TKV-259/3T65	25 A / 2×3P	TKTS-02		
TKV-329/3	TKV-329/3T	TKV-329/3T65	32 A / 2×3P	TK/T3+F3/		
TKV-639/3	-	TKV-639/3T65	63 A / 2×3P	TKTS-03		
TKV-129/3	-	-	125 A / 2×3P	-		
TKV-169/3	-	-	160 A / 2×3P	-		
TKV-209/4	-	TKV-209/4T65	20 A / 2×4P	TKTS-01		<p>90°</p>
TKV-259/4	-	TKV-259/4T65	25 A / 2×4P	TKTS-02		
TKV-329/4	TKV-329/4T	TKV-329/4T65	32 A / 2×4P	TK/T3+F3/		
TKV-639/4	-	-	63 A / 2×4P	-		
TKV-129/4	-	-	125 A / 2×4P	-		
TKV-169/4	-	-	160 A / 2×4P	-		
TKB-206/3	TKB-206/3T	TKB-206/3T65	20 A / 2×3P	TK/T2+F1/	<p>60°</p>	
TKB-256/3	-	TKB-256/3T65	25 A / 2×3P	TKTS-02		
TKB-326/3	TKB-326/3T	TKB-326/3T65	32 A / 2×3P	TK/T3+F3/		
TKB-636/3	-	TKB-636/3T65	63 A / 2×3P	TKTS-03		
TKB-126/3	-	-	125 A / 2×3P	-		
TKB-166/3	-	-	160 A / 2×3P	-		
TKB-206/4	-	TKB-206/4T65	20 A / 2×4P	TKTS-01		<p>60°</p>
TKB-256/4	-	TKB-256/4T65	25 A / 2×4P	TKTS-02		
TKB-326/4	TKB-326/4T	TKB-326/4T65	32 A / 2×4P	TK/T3+F3/		
TKB-636/4	-	-	63 A / 2×4P	-		
TKB-126/4	-	-	125 A / 2×4P	-		
TKB-166/4	-	-	160 A / 2×4P	-		
TKB-209/3	TKB-209/3T	TKB-209/3T65	20 A / 2×3P	TK/T2+F1/	<p>90°</p>	
TKB-259/3	-	TKB-259/3T65	25 A / 2×3P	TKTS-02		
TKB-329/3	TKB-329/3T	TKB-329/3T65	32 A / 2×3P	TK/T3+F3/		
TKB-639/3	-	TKB-639/3T65	63 A / 2×3P	TKTS-03		
TKB-129/3	-	-	125 A / 2×3P	-		
TKB-169/3	-	-	160 A / 2×3P	-		
TKB-209/4	-	TKB-209/4T65	20 A / 2×4P	TKTS-01		<p>90°</p>
TKB-259/4	-	TKB-259/4T65	25 A / 2×4P	TKTS-02		
TKB-329/4	TKB-329/4T	TKB-329/4T65	32 A / 2×4P	TK/T3+F3/		
TKB-639/4	-	-	63 A / 2×4P	-		
TKB-129/4	-	-	125 A / 2×4P	-		
TKB-169/4	-	-	160 A / 2×4P	-		

Motorkapcsolók

TKM-20/Q	TKM-20/QT	TKM-20/QT65	5,5 kW	TK/T1+F1/		<p>60°</p>	
TKM-25/Q	TKM-25/QT	TKM-25/QT65	7,5 kW	TK/T2+F1/			
TKM-32/Q	TKM-32/QT	TKM-32/QT65	11 kW	TK/T3+F3/			
TKM-63/Q	TKM-63/QT	TKM-63/QT65	18,5 kW	TK/T3+F3/			
TKM-12/Q	-	TKM-12/QT65	30 kW	TKTS-03			
TKM-16/Q	-	TKM-16/QT65	37 kW	TKTS-03			
TKM-20/N	TKM-20/NT	TKM-20/NT65	5,5 kW	TK/T2+F1/			<p>60°</p>
TKM-25/N	-	TKM-25/NT65	7,5 kW	TKTS-02			
TKM-32/N	TKM-32/NT	TKM-32/NT65	11 kW	TK/T3+F3/			
TKM-63/N	-	TKM-63/NT65	18,5 kW	TKTS-03			
TKM-12/N	-	-	30 kW	-			
TKM-16/N	-	-	37 kW	-			

<table border="1" style="display: inline-table; vertical-align: middle;"> <tr><td>1</td><td>0</td><td>2</td></tr> <tr><td>x</td><td>x</td><td>x</td></tr> <tr><td>2</td><td>x</td><td>x</td></tr> <tr><td>3</td><td>x</td><td>x</td></tr> </table>			1	0	2	x	x	x	2	x	x	3	x	x	L	A	a	b	d	<table border="1" style="display: inline-table; vertical-align: middle;"> <tr><td>1</td><td>3</td><td>5</td><td>7</td></tr> <tr><td>2</td><td>4</td><td>6</td><td>8</td></tr> </table>			1	3	5	7	2	4	6	8
1	0	2																												
x	x	x																												
2	x	x																												
3	x	x																												
1	3	5	7																											
2	4	6	8																											
-90°	0°	90°	(mm)	(mm)	(mm)	(mm)	(mm)																							
1-2	x		50,8	43	48	48	36	2	4	6	8	10	12																	
3-4		x	61,4	45,2	48	48	36																							
5-6	x		67,6	58	64	64	48																							
7-8		x	93,7	66	64	64	48																							
9-10	x		110	84	88	88	68	1	3	5	7	9	11																	
11-12		x	130	88	88	88	68	L1	L2	L3																				
	-90°	0°	90°		-90°	0°	90°																							
1-2	x			9-10	x		60,4	43	48	48	36																			
3-4		x		11-12		x	74,2	45,2	48	48	36	2	4	6		8	10	12	14	16										
5-6	x			13-14	x		80,4	58	64	64	48																			
7-8		x		15-16		x	115,2	66	64	64	48																			
							136	84	88	88	68	L1	L2	L3		N														
							163	88	88	88	68																			
	-60°	0°	60°																											
1-2	x			9-10	x		60,4	43	48	48	36																			
3-4		x		11-12		x	74,2	45,2	48	48	36	2	4	6		8	10	12												
5-6	x			13-14	x		80,4	58	64	64	48																			
7-8		x		15-16		x	115,2	66	64	64	48																			
							136	84	88	88	68	L1	L2	L3																
							163	88	88	88	68																			
	-60°	0°	60°																											
1-2	x			9-10	x		60,4	43	48	48	36																			
3-4		x		11-12		x	74,2	45,2	48	48	36	2	4	6		8	10	12	14	16										
5-6	x			13-14	x		80,4	58	64	64	48																			
7-8		x		15-16		x	115,2	66	64	64	48																			
							136	84	88	88	68	L1	L2	L3		N														
							163	88	88	88	68																			
	-90°	0°	90°																											
1-2	x			9-10	x		60,4	43	48	48	36																			
3-4		x		11-12		x	74,2	45,2	48	48	36	2	4	6		8	10	12												
5-6	x			13-14	x		80,4	58	64	64	48																			
7-8		x		15-16		x	115,2	66	64	64	48																			
							136	84	88	88	68	L1	L2	L3																
							163	88	88	88	68																			
	-90°	0°	90°																											
1-2	x			9-10	x		60,4	43	48	48	36																			
3-4		x		11-12		x	74,2	45,2	48	48	36	2	4	6		8	10	12	14	16										
5-6	x			13-14	x		80,4	58	64	64	48																			
7-8		x		15-16		x	115,2	66	64	64	48																			
							136	84	88	88	68	L1	L2	L3		N														
							163	88	88	88	68																			
	0	60°																												
1-2	x						41,2	43	48	48	36																			
3-4	x						48,6	45,2	48	48	36																			
5-6	x						54,8	58	64	64	48																			
							72,2	66	64	64	48																			
							84	84	88	88	68																			
							97	88	88	88	68																			
	-60°	0°	60°																											
1-2	x		x				50,8	43	48	48	36																			
3-4	x		x				61,4	45,2	48	48	36																			
5-6	x						67,6	58	64	64	48																			
7-8			x				93,7	66	64	64	48																			
9-10			x				111	84	88	88	68																			
11-12	x						130	88	88	88	68																			

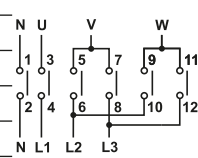
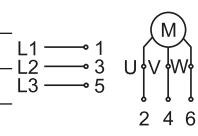

TRACON									
IP 42			+		+				
Motorkapcsolók	TKM-20/C	-		TKM-20/CT65	-	Y-Δ 5,5 kW	TKTS-01		
	TKM-25/C	-		TKM-25/CT65	-	Y-Δ 7,5 kW	TKTS-02		
	TKM-32/C	TKM-32/CT		TKM-32/CT65	-	Y-Δ 11 kW	TK/T3+F3/		
	TKM-63/C	-		-	-	Y-Δ 18,5 kW	-		
	TKM-12/C	-		-	-	Y-Δ 30 kW	-		
	TKM-16/C	-		-	-	Y-Δ 37 kW	-		
	TKM-20/D	-		TKM-20/DT65	-	Dahlander 5,5 kW	TKTS-01		
	TKM-25/D	-		TKM-25/DT65	-	Dahlander 7,5 kW	TKTS-02		
	TKM-32/D	TKM-32/DT		TKM-32/DT65	-	Dahlander 11 kW	TK/T3+F3/		
	TKM-63/D	-		-	-	Dahlander 18,5 kW	-		
	TKM-12/D	-		-	-	Dahlander 30 kW	-		
	TKM-16/D	-		-	-	Dahlander 37 kW	-		
Műszerátkapcsolók	TKU-F	-		-	-	Voltmérő-átkapcsoló fázisfeszültségre	-		
	TKU-V	-		-	-	Voltmérő-átkapcsoló vonali feszültségre	-		
	TKU-K	-		-	-	Voltmérő-átkapcsoló vonali és fázisfeszültségre	-		
	TKI-F	-		-	-	Árammérő-átkapcsoló fázisáramra	-		
Főkapcsolók	TKF-20	TKF-20T		TKF-20T65			20 A / 4P	TK/T3+F3/	
	TKF-25	TKF-25T		TKF-25T65			25 A / 4P	TK/T3+F3/	
	TKF-32	TKF-32T		TKF-32T65			32 A / 4P	TK/T3+F3/	
	TKF-63	TKF-63T		TKF-63T65			63 A / 4P	TK/T3+F3/	
	TKFK-20	TKFK-20T		TKFK-20T65			20 A / 4P	TK/T2+F2/	
	TKFK-25	-		-			25 A / 4P	-	
	TKFK-32 *	-		-			32 A / 4P	-	
	TKFK-63 *	-		-			63 A / 4P	-	
	TKFL-20	TKFL-20TS		TKFL-20T65S			20 A / 4P	TK/T3+F3S/	
	TKFL-25	TKFL-25TS		TKFL-25T65S			25 A / 4P	TK/T3+F3S/	
	TKFL-32	TKFL-32TS		TKFL-32T65S			32 A / 4P	TK/T3+F3S/	
	TKFL-63	TKFL-63TS		TKFL-63T65S			63 A / 4P	TK/T3+F3S/	

* A kapcsoló két elemből áll: felül karos kapcsoló + alul kulcsos zárszerkezet

<table border="1"> <tr><td>1</td><td>0</td><td>2</td></tr> <tr><td>x</td><td>x</td><td>x</td></tr> <tr><td>2</td><td>x</td><td>x</td></tr> <tr><td>3</td><td>x</td><td>x</td></tr> </table>			1	0	2	x	x	x	2	x	x	3	x	x	L	A	a	b	d	<table border="1"> <tr><td>1</td><td>3</td><td>5</td><td>7</td></tr> <tr><td>2</td><td>4</td><td>6</td><td>8</td></tr> </table>		1	3	5	7	2	4	6	8
1	0	2																											
x	x	x																											
2	x	x																											
3	x	x																											
1	3	5	7																										
2	4	6	8																										
-60°	0°	60°	-60°	0°	60°	(mm)	(mm)	(mm)	(mm)	(mm)																			
1-2	x	x	9-10	x		57	44	48	48	36																			
3-4	x	x	11-12	x		70	46	48	48	36																			
5-6		x	13-14		x	78	58	64	64	48																			
7-8		x	15-16		x	112	66	64	64	48																			
						138	84	88	88	68																			
						163	88	88	88	68																			
-60°	0°	60°	-60°	0°	60°																								
1-2		x	9-10		x	57	44	48	48	36																			
3-4		x	11-12		x	70	46	48	48	36																			
5-6	x		13-14	x		78	58	64	64	48																			
7-8	x		15-16	x		112	66	64	64	48																			
						138	84	88	88	68																			
						163	88	88	88	68																			
0	A	B	C																										
1-2	x																												
3-4			x																										
5-6		x																											
9-10	x	x	x	50,8	43	48	48	36																					
0	AB	BC	CA																										
1-2	x	x																											
5-6			x																										
7-8	x																												
11-12		x	x	50,8	43	48	48	36																					
CA	BC	AB	0	A	B	C																							
1-2		x				x																							
3-4	x																												
5-6						x																							
7-8		x	x				50,8	43	48	48	36																		
9-10	x		x		x																								
11-12				x	x	x																							
0	A	B	C																										
1-2	x	x	x																										
5-6	x	x	x																										
7-8	x	x	x																										
9-10		x		60,4	43	48	48	36																					
13-14	x																												
15-16			x																										
0°	90°																												
1-2	x																												
3-4	x	41,2	43	64	64	48																							
5-6	x	48,6	45,2	64	64	48																							
7-8	x	54,8	58	64	64	48																							
		72,2	66	64	64	48																							
0°	90°																												
1-2	x																												
3-4	x	41,2	43	48	48	36																							
5-6	x	48,6	45,2	48	48	36																							
7-8	x	75	58/105	64	64/112	48/96																							
		93	66/105	64	64/122	48/96																							
0°	90°																												
1-2	x																												
3-4	x	44,2	43	64	64	48																							
5-6	x	52,1	45,2	64	64	48																							
7-8	x	54,8	58	64	64	48																							
		72,2	66	64	64	48																							



Szakaszolókapcsolók

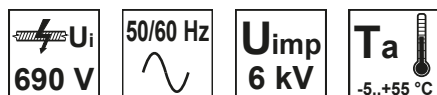

		TS-20	TS-32	TS-40	TS-63	TS-80	TS-100
I_{th} (A)		20	32	40	63	80	100
P_e (kW), 400 V~	AC-23A	7,5	11	15	22	30	37
	AC-3	5,5	7,5	11	18,5	22	30
($\times 10^5$)		5	5	3	1,5	1,5	1,5
($\times 10^5$)		3	3	1,2	1	1	1
		200	150	100	60	30	30
mm ²		1×2,5	1×4,0	1×6,0	1×25	1×50	1×70
		2×1,5	2×1,5	2×4,0	2×10	2×25	2×35
		1×2,5	1×4,0	1×4,0	1×16	1×35	1×50
		2×1,5	2×1,5	2×2,5	2×6	2×10	2×16
I_{cw} (1s, A)		180	264	360	516	684	840
		20 A gG	35 A gG	50 A gG	63 A gG	80 A gG	100 A gG

3P Kapcsolási ábra 4P

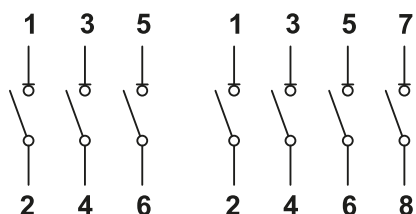

Előlap

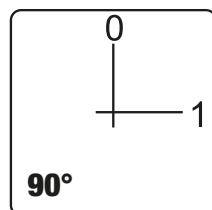

Főbb jellemzők







- alkalmas terhelés alatti be- és kikapcsolásra valamint leválasztásra
- lehet alkalmazni motorkapcsolóként, főkapcsolóként, szakaszolóként, biztonsági kapcsolóként
- nagy villamos és mechanikai élettartam
- kettős megszakítású érintkezők
- kézi működtetéstől független kapcsolási gyorsaság
- a feszültség alatt álló részek véletlen érintés ellen védettek
- a kapcsolótörzs önkioltó (UL94-V0), nagy mechanikai szilárdságú szigetelő anyagból



RELEVANT STANDARD
EN 60947-3



Szakaszolókapcsoló

TRACON						L	A	B	a	d	c
IP 42						(mm)	(mm)	(mm)	(mm)	(mm)	(mm)
TS-20/3	TS-20/3T	TS-20/3T65	20 A / 3P	TK/T3+F3/		61	54	42	64	48	4.2
TS-32/3	TS-32/3T	TS-32/3T65	32 A / 3P			61	54	42	64	48	4.2
TS-40/3	TS-40/3T	TS-40/3T65	40 A / 3P			67	64	50	64	48	4.2
TS-63/3	TS-63/3T	TS-63/3T65	63 A / 3P			67	64	50	64	48	4.2
TS-80/3	-	TS-80/3T65	80 A / 3P	TKTS-03		82	80	70	64	48	4.2
TS-10/3	-	TS-10/3T65	100 A / 3P	TKTS-03		82	80	70	88	68	5.2
TS-20/4	TS-20/4T	TS-20/4T65	20 A / 4P	TK/T3+F3/		61	54	55.5	64	48	4.2
TS-32/4	TS-32/4T	TS-32/4T65	32 A / 4P			61	54	55.5	64	48	4.2
TS-40/4	TS-40/4T	TS-40/4T65	40 A / 4P			67	64	66	64	48	4.2
TS-63/4	TS-63/4T	TS-63/4T65	63 A / 4P			67	64	66	64	48	4.2
TS-80/4	-	-	80 A / 4P	-		82	80	92.5	64	48	4.2
TS-10/4	-	-	100 A / 4P	-		82	80	92.5	88	68	5.2

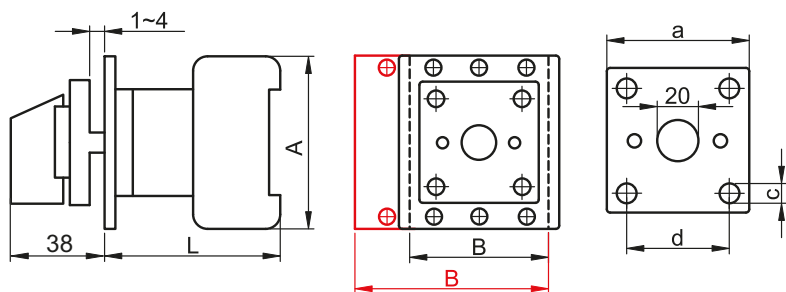

Szakaszolókapcsoló ajtókuplunggal

TRACON		L	A	B	a	d	c	x	y
		(mm)	(mm)	(mm)	(mm)	(mm)	(mm)	(mm)	(mm)
TS-20/3K	20 A / 3P	50	54	42	64	48	4.2	22	62
TS-32/3K	32 A / 3P	50	54	42	64	48	4.2	22	62
TS-40/3K	40 A / 3P	61	64	50	64	48	4.2	25	70
TS-63/3K	63 A / 3P	61	64	50	64	48	4.2	25	70
TS-80/3K	80 A / 3P	68	80	70	64	48	4.2	25	90
TS-10/3K	100 A / 3P	68	80	70	88	68	5.2	25	90
TS-20/4K	20 A / 4P	50	54	55.5	64	48	4.2	22	62
TS-32/4K	32 A / 4P	50	54	55.5	64	48	4.2	22	62
TS-40/4K	40 A / 4P	61	64	66	64	48	4.2	25	70
TS-63/4K	63 A / 4P	61	64	66	64	48	4.2	25	70
TS-80/4K	80 A / 4P	68	80	92.5	64	48	4.2	25	90
TS-10/4K	100 A / 4P	68	80	92.5	88	68	5.2	25	90

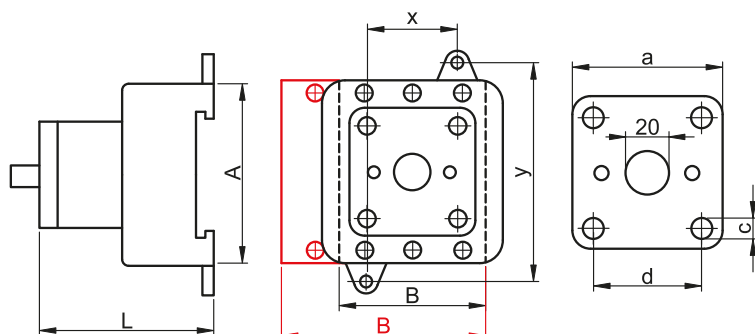

Az ajtókuplung biztonsági reteszeltést hoz létre az elosztószekrény ajtajánál; az ajtó csak a kapcsoló „0”, azaz „KI” állásában nyitható!

Az ajtókuplung tengelyének hossza: 150 mm

300 mm hosszúságú tengely is rendelhető.

Hátsó felerősítésű, 2 db csavarral rögzíthető vagy 35/7,5 mm-es EN 50022 szerinti kalapsínre pattintható.

Biztonsági szakaszolókapcsoló

TRACON					L (mm)	A (mm)	B (mm)	a (mm)	d (mm)	c (mm)
IP 42										
TSS-20/3	TSS-20/3T	TSS-20/3T65S	20 A / 3P	TK/T3+F3/	61	54	42	64	48	4.2
TSS-32/3	TSS-32/3T	TSS-32/3T65S	32 A / 3P		61	54	42	64	48	4.2
TSS-40/3	TSS-40/3T	TSS-40/3T65S	40 A / 3P	TK/T3+F3S/	67	64	50	64	48	4.2
TSS-63/3	TSS-63/3T	TSS-63/3T65S	63 A / 3P		67	64	50	64	48	4.2
TSS-80/3	-	TSS-80/3T65	80 A / 3P	TKTS-03	82	80	70	64	48	4.2
TSS-10/3	-	TSS-10/3T65	100 A / 3P	TKTS-03	82	80	70	88	68	5.2
TSS-20/4	TSS-20/4T	TSS-20/4T65S	20 A / 4P		61	54	55.5	64	48	4.2
TSS-32/4	TSS-32/4T	TSS-32/4T65S	32 A / 4P	TK/T3+F3S/	61	54	55.5	64	48	4.2
TSS-40/4	TSS-40/4T	TSS-40/4T65S	40 A / 4P		67	64	66	64	48	4.2
TSS-63/4	TSS-63/4T	TSS-63/4T65S	63 A / 4P	TK/T3+F3/	67	64	66	64	48	4.2
TSS-80/4	-	-	80 A / 4P	-	82	80	92.5	64	48	4.2
TSS-10/4	-	-	100 A / 4P	-	82	80	92.5	88	68	5.2

A tokozatok sárga fedéllel is rendelhetőek.

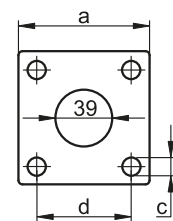
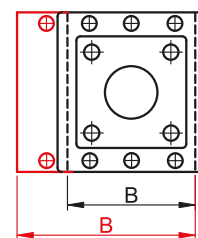
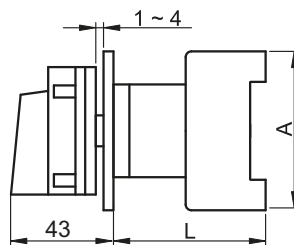

A szakaszolókapcsoló kikapcsolt "OFF" állapotban lakatolható.

Biztonsági lakatolható szakaszolókapcsoló ajtókuplunggal

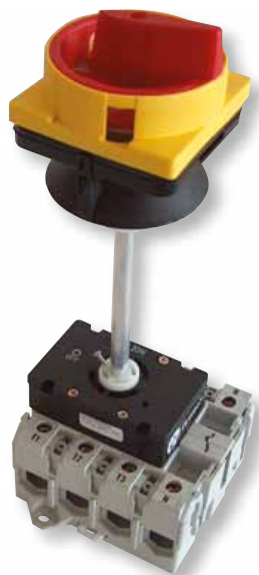

TRACON		L (mm)	A (mm)	B (mm)	a (mm)	d (mm)	c (mm)	x (mm)	y (mm)
TSS-20/3K	20 A / 3P	50	54	42	64	48	4.2	22	62
TSS-32/3K	32 A / 3P	50	54	42	64	48	4.2	22	62
TSS-40/3K	40 A / 3P	61	64	50	64	48	4.2	25	70
TSS-63/3K	63 A / 3P	61	64	50	64	48	4.2	25	70
TSS-80/3K	80 A / 3P	68	80	70	64	48	4.2	25	90
TSS-10/3K	100 A / 3P	68	80	70	88	68	5.2	25	90
TSS-20/4K	20 A / 4P	50	54	55.5	64	48	4.2	22	62
TSS-32/4K	32 A / 4P	50	54	55.5	64	48	4.2	22	62
TSS-40/4K	40 A / 4P	61	64	66	64	48	4.2	25	70
TSS-63/4K	63 A / 4P	61	64	66	64	48	4.2	25	70
TSS-80/4K	80 A / 4P	68	80	92.5	64	48	4.2	25	90
TSS-10/4K	100 A / 4P	68	80	92.5	88	68	5.2	25	90

Az ajtókuplung biztonsági reteszeltet hoz létre az elosztószekrény ajtajánál; az ajtó csak a kapcsoló „0”, azaz „KI” állásában nyitható!

Az ajtókuplung tengelyének hossza: 300 mm

Hátsó felerősítésű, 2 db csavarral rögzíthető vagy 35/7,5 mm-es EN 50022 szerinti kalapsínre pattintható.

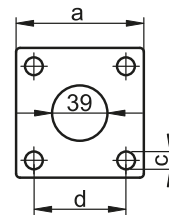
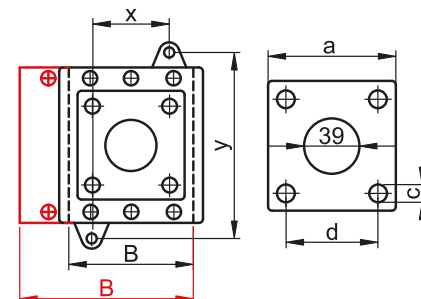
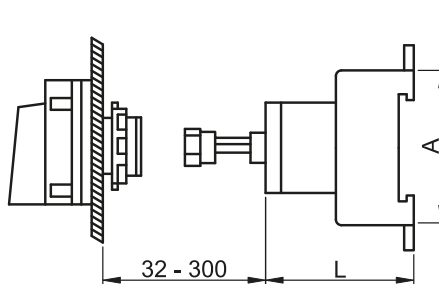

Sorolható lakatolható szakaszolókapcsoló

TRACON		L (mm)	A (mm)	B (mm)	x (mm)	y (mm)
TSM-20/3	20 A / 3P	50	54	42	22	62
TSM-32/3	32 A / 3P	50	54	42	22	62
TSM-20/4	20 A / 4P	50	54	55.5	22	62
TSM-32/4	32 A / 4P	50	54	55.5	22	62

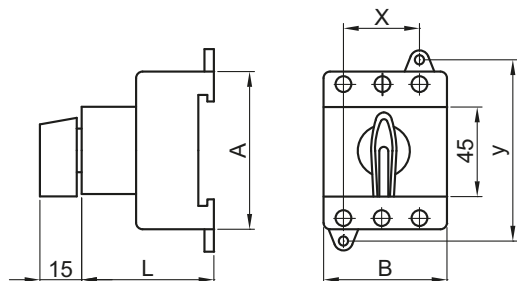

RELEVANT STANDARD
EN 60947-3

45 mm-es szabványos előlap kivágásba illeszkedő, hátsó felerősítésű, 2 db csavarral rögzíthető vagy EN 50022 szabvány szerinti kalapsínre pattintható.

A kapcsolókar KI (OFF) állásban lakatolható.









EVOMS sorolható, lakatolható szakaszolókapcsoló

TRACON	Ith (40 °C)
EVOMS16/3	16 A/3P
EVOMS20/3	20 A/3P
EVOMS25/3	25 A/3P
EVOMS40/3	40 A/3P
EVOMS80/3	80 A/3P
EVOMS100/3	100 A/3P
EVOMS125/3	125 A/3P



F/25

Tartozékok

TRACON		W (mm)	H (mm)	D (mm)		IP..
TK/T3+F3/	 + 	112	108	112	2 × MG-25 2 × MG-32	IP 44
TK/T3+F3S/	 + 	112	108	112	2 × MG-25 2 × MG-32	IP 44
TKTS-03	 + 	140	109	200	2 × MG-25 2 × MG-32	IP 44

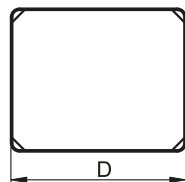
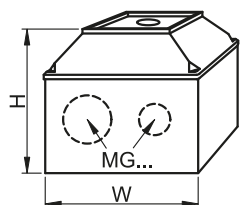

Tömítőkészlet

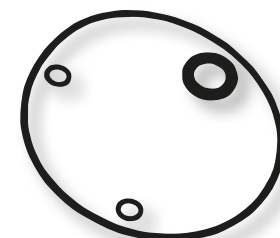

TRACON	
TKT-65/2	TS-20/3, TS-32/3, TS-40/3, TS-63/3, TS-20/4, TS-32/4, TS-40/4, TS-63/4
TKT-65/3	TSS-20/3, TSS-32/3, TSS-40/3, TSS-63/3, TSS-20/4, TSS-32/4, TSS-40/4, TSS-63/4



Kontaktorok

230/400 V AC	T _a -25...+55°C	max. ±30°	AC 1	AC 3	AC 4	AC 15	AC 6b
-----------------	-------------------------------	--------------	---------	---------	---------	----------	----------



TRACON			
	TR1K..	TR1D..	TR1E..
U_m	AC-1, AC-3, AC-15 24 V AC, 48 V AC, 110 V AC, 230 V AC, 400 V AC	AC-1, AC-3, AC-4 24 V AC, 48 V AC, 110 V AC, 230 V AC, 400 V AC	AC-1, AC-3, AC-4 24 V AC, 48 V AC, 230 V AC, 400 V AC
I_e	6...12 A/AC-3	9...95 A/AC-3	115...620 A/AC-3
			

A kontaktor önállóan vagy védelemmel (pl. hőrelé) kiegészítve villamos motorok vagy más kisfeszültségű villamos berendezések távvezérelt működtetésére, kapcsolására alkalmas. A készülékek különféle érzékelőelemekkel kiegészítve számos automatizálási feladatra is alkalmassá tehetők. Homlokoldalukra segédérintkező és időzítőegység szerelhető, valamint oldalsó segédérintkezővel is elláthatóak. Segítségükkel jelző és/vagy reteszelési feladatok segédáramköri megoldása lehetséges.

A kontaktorok csak váltakozófeszültségű működtetőtekerccsel készülnek 5 típusváltozatban. A kontaktorokat felhasználási céljuknak és az alkalmazási kategóriának (lásd: FÜGGELÉK) megfelelően kell kiválasztani.

A kontaktor csak szinuszos váltakozó, egyenáramú összetevővel nem rendelkező feszültséggel működtethető. Elektronikus vezérlő- és szabályozó áramkörökben való alkalmazás vagy magas felharmonikus tartalmú működtető feszültség esetén ennek megfelelő szűréséről még a kontaktor üzembe helyezése előtt gondoskodni kell.

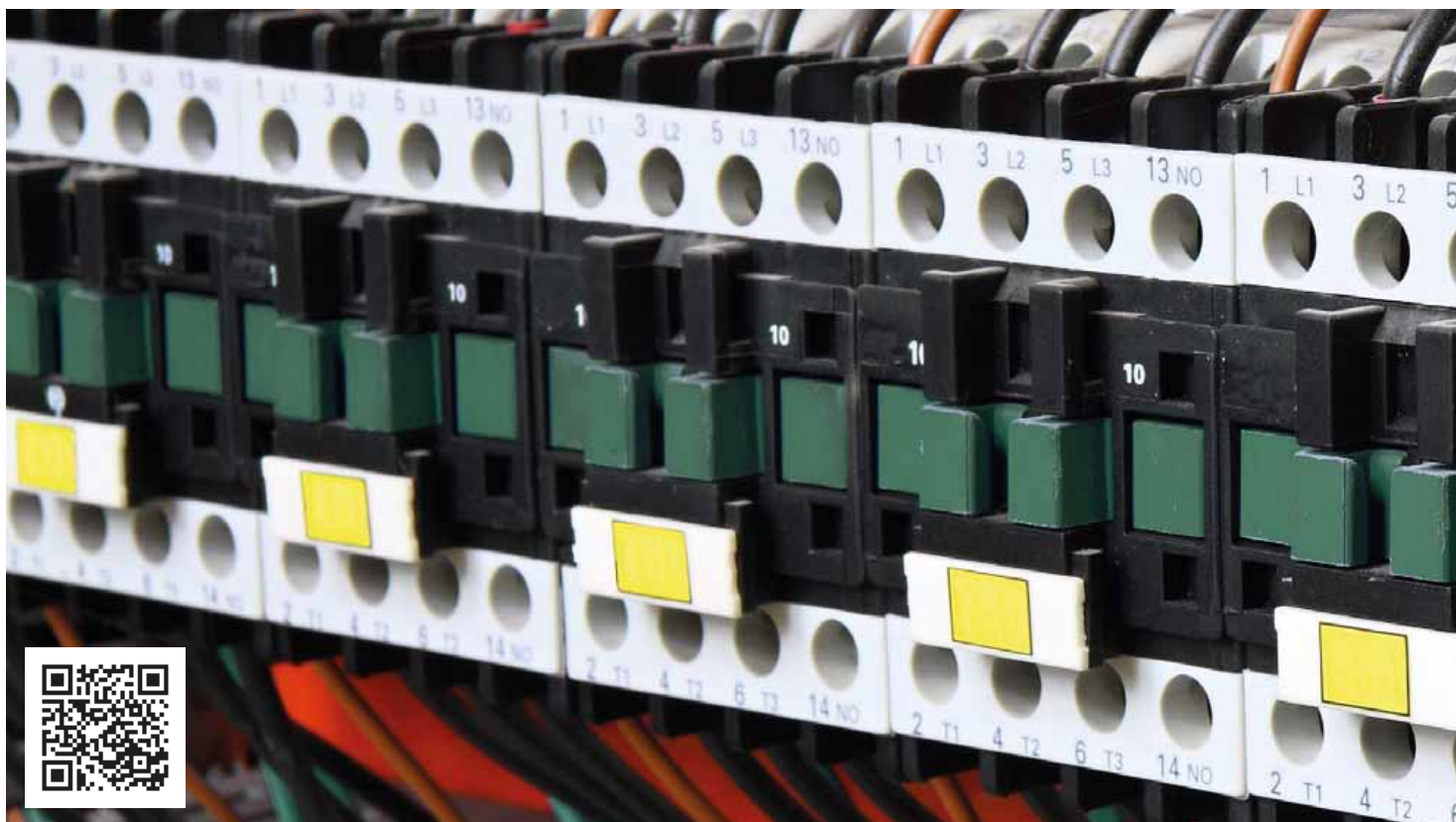

Segédkontaktorok (6 A...12 A)

230/400 V AC	U_i 690 V	U_e 660 V	I_{th} 20 A	ON-OFF-ON... sc/h x4.800	3×10^6	$\times 10^6$	$[mm^2]$ 1-4	P_{ON} 30 VA	P_{HOLD} 4,5 VA	35x7.5	T_a -25...+55°C	max. ± 30	IP 20
-----------------	----------------	----------------	------------------	--------------------------------	-----------------	---------------	-----------------	-------------------	----------------------	--------	----------------------	---------------	-----------------

	U_m	TRACON			
		6A/AC-3	9A/AC-3	12A/AC-3	
	24 V~ 48 V~ 110 V~ 230 V~ 400 V~	- - - - -	TR1K0904B7 TR1K0904E7 TR1K0904F7 TR1K0904 TR1K0904V7	TR1K1204B7 TR1K1204E7 TR1K1204F7 TR1K1204 TR1K1204V7	
	24 V~ 48 V~ 110 V~ 230 V~ 400 V~	TR1K0610B7 TR1K0610E7 TR1K0610F7 TR1K0610 TR1K0610V7	TR1K0910B7 TR1K0910E7 TR1K0910F7 TR1K0910 TR1K0910V7	TR1K1210B7 TR1K1210E7 TR1K1210F7 TR1K1210 TR1K1210V7	
	24 V~ 48 V~ 110 V~ 230 V~ 400 V~	TR1K0601B7 TR1K0601E7 TR1K0601F7 TR1K0601 TR1K0601V7	TR1K0901B7 TR1K0901E7 TR1K0901F7 TR1K0901 TR1K0901V7	TR1K1201B7 TR1K1201E7 TR1K1201F7 TR1K1201 TR1K1201V7	
	24 V~ 48 V~ 110 V~ 230 V~ 400 V~	- - - - -	TR1K0908B7 TR1K0908E7 TR1K0908F7 TR1K0908 TR1K0908V7	- - - - -	
I_e (A)	AC-1 AC-3 AC15	20 6 2	20 9 3	20 12 4	
P_e (kW)	220/230 V	AC-3	1,5	2,2	3
	380/400 V	AC-3	2,2	4	5,5
	415 V	AC-3	2,2	4	5,5
	500 V, 660/690 V	AC-3	3	4	4
			10 A aM	10 A aM	16 A aM

Méretrajzok és felerősítési furatok

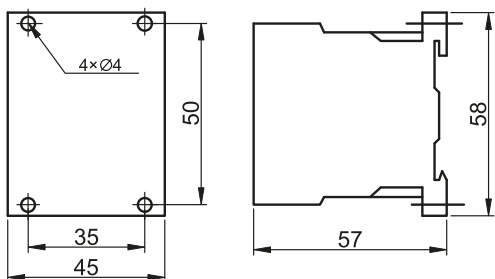

Szerelőlapra szerelve

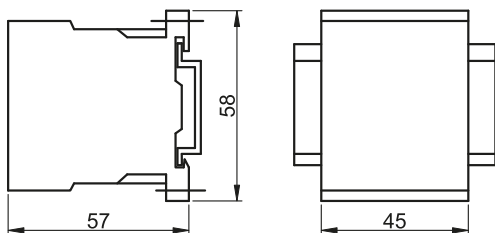

Sínre szerelve (35x7,5 mm)



RELEVANT STANDARD
EN 60947-4-1

RELEVANT STANDARD
EN 60947-1

TR1D típusú általános felhasználású kontaktorok (9 A ... 32 A)

230/400 V AC	U_i 660 V	U_e 660 V	ON-OFF-ON... sc/h x3.600	3x10⁶	x10⁶	AUX (mm ²) 1-4	T_a -25...+55°C	IP 20	Piktogramok	I/O
-----------------	-------------------------------	-------------------------------	--------------------------------	-------------------------	------------------------	-------------------------------	-------------------------------------	--------------	--------------------	------------

		TRACON					
		U _m	9A/AC-3	12A/AC-3	18A/AC-3	25A/AC-3	32A/AC-3
	24 V~		TR1D0910B7	TR1D1210B7	TR1D1810B7	TR1D2510B7	TR1D3210B7
	48 V~		TR1D0910E7	TR1D1210E7	TR1D1810E7	TR1D2510E7	TR1D3210E7
	110 V~		TR1D0910F7	TR1D1210F7	TR1D1810F7	TR1D2510F7	TR1D3210F7
	230 V~		TR1D0910	TR1D1210	TR1D1810	TR1D2510	TR1D3210
	400 V~		TR1D0910V7	TR1D1210V7	TR1D1810V7	TR1D2510V7	TR1D3210V7
	24 V~		TR1D0901B7	TR1D1201B7	TR1D1801B7	TR1D2501B7	TR1D3201B7
	48 V~		TR1D0901E7	TR1D1201E7	TR1D1801E7	TR1D2501E7	TR1D3201E7
	110 V~		TR1D0901F7	TR1D1201F7	TR1D1801F7	TR1D2501F7	TR1D3201F7
	230 V~		TR1D0901	TR1D1201	TR1D1801	TR1D2501	TR1D3201
	400 V~		TR1D0901V7	TR1D1201V7	TR1D1801V7	TR1D2501V7	TR1D3201V7
I_e (A)	AC-1		25	25	32	40	50
	AC-3		9	12	18	25	32
P_e (kW)	AC-4		3,5	5	7,7	8,5	12
	220/230 V	AC-3	2,2	3	4	5,5	7,5
	380/400 V	AC-3	4	5,5	7,5	11	15
	380/400 V	AC-4	4	2,5	3	3,7	4,5
	415 V	AC-3	4	5,5	9	11	15
500 V, 660/690 V	AC-3	5,5	7,5	10	15	18,5	
I_{aux} (A)			5	5	5	5	5
			10 A aM	16 A aM	20 A aM	32 A aM	40 A aM
mm ²			4	4	6	10	10
			60 VA	60 VA	60 VA	90 VA	90 VA
			7 VA	7 VA	7 VA	7,5 VA	7,5 VA

Méretrajzok és felerősítési furatok

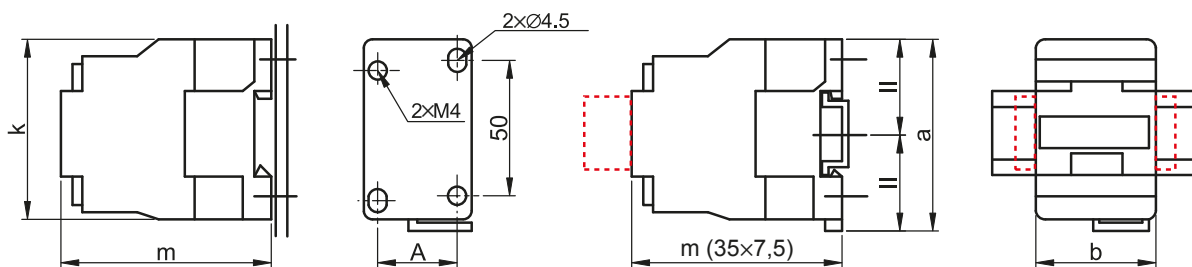

Szerelőlapra szerelve

Sínrre szerelve



TRACON	TR1D09..	TR1D12..	TR1D18..	TR1D25..	TR1D32..
m (mm)	80	80	85	93	98
A (mm)	35	35	35	44	44
k (mm)	71	71	71	80	80
a (mm)	74	74	74	84	84
b (mm)	46	46	47	57	57
m (35x7,5)	82	82	87	95	100

TR1D típusú általános felhasználású kontaktorok (40 A ... 95 A)

230/400 V AC	U_i 660 V	U_e 660 V	ON-OFF-ON... sc/h x3.600	3×10^6	$\times 10^6$	AUX (mm ²) 1-4	T_a -25...+55°C	max. $\pm 30^\circ$	IP 20	Piktogramok	I/O
-----------------	----------------	----------------	--------------------------------	-----------------	---------------	-------------------------------	----------------------	---------------------	----------	-------------	-----

		TRACON					
		U_m	40A/AC-3	50A/AC-3	65A/AC-3	80A/AC-3	95A/AC-3
		24 V~	TR1D4011B7	TR1D5011B7	TR1D6511B7	TR1D8011B7	TR1D9511B7
		48 V~	TR1D4011E7	TR1D5011E7	TR1D6511E7	TR1D8011E7	TR1D9511E7
		110 V~	TR1D4011F7	TR1D5011F7	TR1D6511F7	TR1D8011F7	TR1D9511F7
		230 V~	TR1D4011	TR1D5011	TR1D6511	TR1D8011	TR1D9511
		400 V~	TR1D4011V7	TR1D5011V7	TR1D6511V7	TR1D8011V7	TR1D9511V7
		I_e (A)	AC-1	60	80	80	125
	AC-3	40	50	65	80	95	
	AC-4	18,5	24	28	37	44	
P_e (kW)	220/230 V	AC-3	11	15	18,5	22	25
	380/400 V	AC-3	18,5	22	30	37	45
	380/400 V	AC-4	5,5	7,5	9	10	15
	415 V	AC-3	22	25	37	45	45
	500 V	AC-3	22	30	37	55	55
	660/690 V	AC-3	30	33	37	45	45
	1000 V	AC-3	-	30	37	45	45
I_{aux} (A)		5	5	5	5	5	
		50 A aM	50 A aM	63 A aM	80 A aM	100 A aM	
mm ²		25	25	25	50	50	
P_{ON} 		200 VA	200 VA	200 VA	200 VA	200 VA	
P_{HOLD} 		20 VA	20 VA	20 VA	20 VA	20 VA	

Méretreajzok és felerősítési furatok

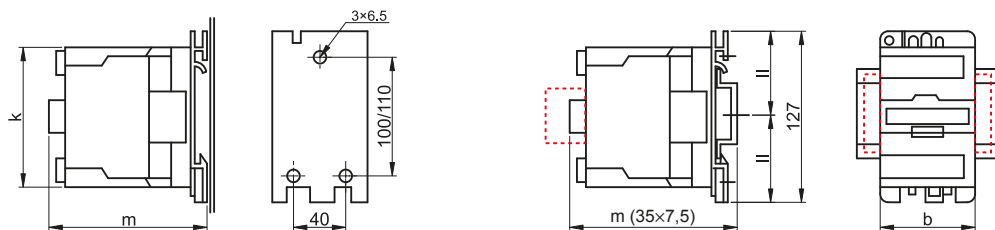

Szerelőlapra szerelve



Sínre szerelve



TRACON	TR1D40..	TR1D50..	TR1D65..	TR1D80..	TR1D95..
m (mm)	114	114	114	125	125
k (mm)	107	107	107	123	123
b (mm)	75	75	75	85	85
m (35x7,5)	116	116	116	127	127



TEMS Tokozott motorvédő kapcsoló kombinációk

TRACON	P_e (kW), AC-3*	I_e (A), AC-3*	U_m			
TEMS1-091	1,5	3,5	400 V~	9 A / AC-3	2,5 – 4 A	6 A aM
TEMS1-092	2,2	5	400 V~	9 A / AC-3	4 – 6 A	10 A aM
TEMS1-093	3	6,3	400 V~	9 A / AC-3	5,5 – 8 A	10 A aM
TEMS1-094	4	8,5	400 V~	9 A / AC-3	7 – 10 A	16 A aM
TEMS1-121	5	11,5	400 V~	12 A / AC-3	9 – 13 A	16 A aM
TEMS1-181	7,5	15,5	400 V~	18 A / AC-3	12 – 18 A	20 A aM
TEMS2-251	11	22	400 V~	25 A / AC-3	17 – 25 A	25 A aM
TEMS2-321	15	30	400 V~	32 A / AC-3	23 – 32 A	40 A aM
TEMS3-401	18,5	37	400 V~	40 A / AC-3	30 – 40 A	40 A aM
TEMS3-501	22	44	400 V~	50 A / AC-3	37 – 50 A	63 A aM
TEMS3-651	25	57	400 V~	65 A / AC-3	48 – 65 A	80 A aM
TEMS3-801	37	72,5	400 V~	80 A / AC-3	55 – 70 A	80 A aM
TEMS3-802	37	72,5	400 V~	80 A / AC-3	63 – 80 A	80 A aM
TEMS3-951	45	85	400 V~	95 A / AC-3	80 – 93 A	100 A aM

* Az adatok háromfázisú, deltakapcsolásban üzemeltetett kalickás motorra vonatkoznak.

A készülék egy vezérlő kontaktorból, egy termikus túláramvédelmi reléből, egy zöld BE, egy piros KI gombból és egy - két részből álló - műanyag, illetve acéllemez házból áll. A kontaktor és a túláramvédelmi relé műszaki paraméterei határozzák meg, hogy milyen teljesítményű motort lehet a kombinációval indítani. A termikus túláramvédelmi relével beállítható a védendő motor műszaki paramétereire illeszkedő áramvédelmi szint. A BE/KI nyomógombokkal végezhető el a motor be- és kikapcsolása. Amennyiben a hőrelé működése miatt áll le a motor, akkor a visszakapcsolás előtt meg kell nyomni a KI gombot a reteszelés oldásához! A ház egyszerűen a felületre szerelhető az alján lévő rögzítő furatok segítségével. A kábel bevezetését kiüthető kábelnyílások segítik a tokozat tetején, alján és a hátoldalon. A működtető kör elő van kábelezve, a kontaktor és a hőrelé össze van építve. A készülék a csatlakozó kábelek bekötése után működésre kész. A készülékeket el kell látni külső zárlatvédelemmel!

A TEMS1 típus műszaki adatai és típusválasztéka

TRACON	TEMS1-091	TEMS1-092	TEMS1-093	TEMS1-094	TEMS1-121	TEMS1-181
I_e (A), AC-3	400 V 660 V	3,5	5	6,3	8,5	11,5 15,5
I_{th} (A)	400 V	25	25	25	25	32
P_e (kW), AC-3	400 V 660 V	1,5	2,2	3	4	5,5 7,5 10
AUX I_{th} (A)		6	6	6	6	6
P_m (VA)	AC-15	300	300	300	300	300
	DC-13	30	30	30	30	30

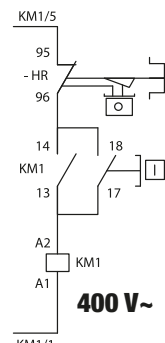
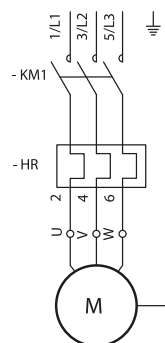
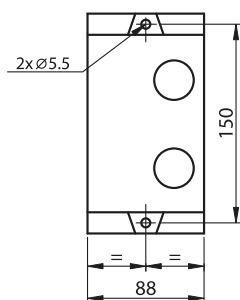
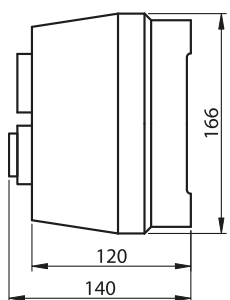

A betápláló kábelek bevezetésére a műanyag ház alsó részének a tetején 2 db **PG-13,5**; alsó részén 1 db **PG-16** és 1 db **PG-13,5**-ös tömítőszelencéhez méretezett, könnyen kitörhető nyílás található.

A TEMS2 típus műszaki adatai és típusválasztéka

400 V AC	U_i 660 V	3×10^6	8×10^5	T_a 0..+55 °C	IP 55
-----------------	-----------------------	-----------------	-----------------	--------------------	--------------



Piktogramok I/O

TRACON	TEMS2-251	TEMS2-321	
I_e (A), AC-3	400 V 660 V	22 18	30 21,3
I_{th} (A)	400 V	40	50
P_e (kW), AC-3	400 V 660 V	11 15	15 18,5
I_{th} (A)		6	6
P_m (VA)	AC-15	300	300
	DC-13	30	30

RELEVANT STANDARD
EN 60529

RELEVANT STANDARD
EN 60695-2-1

RELEVANT STANDARD
EN 60439



A betápláló kábelek bevezetésére a műanyag ház alsó részének a tetején 2 db **PG-16**; alsó részén 1 db **PG-13,5** és 1 db **PG-16**-os tömítőszelencéhez méretezett, könnyen kitörhető, menetes nyílás található.

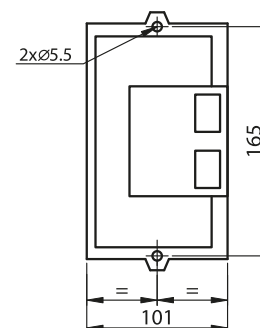
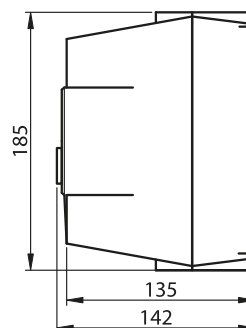
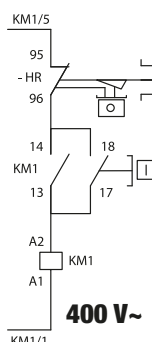
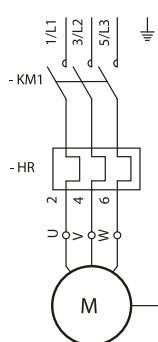

A TEMS3 típus műszaki adatai és típusválasztéka

400 V AC	U_i 660 V	3×10^6	6×10^5	T_a 0..+55 °C	IP 55
-----------------	-----------------------	-----------------	-----------------	--------------------	--------------

Piktogramok I/O



TRACON	TEMS3-401	TEMS3-501	TEMS3-651	TEMS3-801	TEMS3-802	TEMS3-951	
I_e (A), AC-3	400 V 660 V	37 34,6	44 39	60 42	72,5 49	72,5 49	85 49
I_{th} (A)	400 V	60	80	80	125	125	125
P_e (kW), AC-3	400 V 660 V	18,5 30	22 33	30 37	37 45	37 45	45 55
I_{th} (A)		6	6	6	6	6	6
P_m (VA)	AC-15	300	300	300	300	300	300
	DC-13	30	30	30	30	30	30



A fém tokozattal ellátott kiviteli változat kontaktorán található 1 db nyitó segédérintkező további jelzési és vezérlési feladatokra is felhasználható. A betápláló kábelek bevezetésére a ház alsó részének a tetején 1 db **PG-29** és 1 db **PG-13,5**; alsó részén 2 db **PG-29** és 1 db **PG-13,5**-es tömítő szelencéhez méretezett, záródugóval ellátott nyílás található. A fém tokozat I. év. o., üzembe helyezés előtt földelni kell!

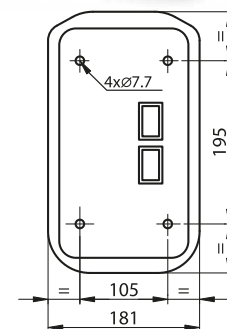
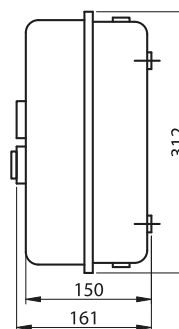
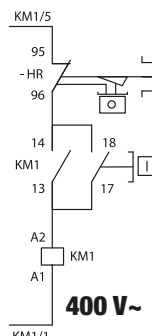
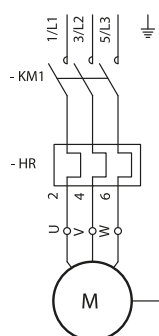

Nagyáramú kontaktorok (115 A...620 A)

400 V AC	660 V	U_e 660 V	AUX (mm²) 1-4	T_a -25...+55°C	max. ±30°	IP 20
-----------------	--------------	----------------------------	---------------------------------	----------------------------------	------------------	--------------



		TRACON			
		U _m	115A/AC-3	150A/AC-3	170A/AC-3
		24 V~	TR1E115B7	-	TR1E170B7
		48 V~	TR1E115E7	TR1E150E7	TR1E170E7
		230 V~	TR1E115	TR1E150	TR1E170
		400 V~	TR1E115V7	TR1E150V7	TR1E170V7
I_e (A)	AC-1	250	250	250	
	AC-3	115	150	170	
P_e (kW)	AC-4	40	50	60	
	220/230 V	30	40	55	
	380/400 V	55	75	90	
	415 V	59	80	100	
	500 V	75	90	110	
	660/690 V	80	100	110	
		1000 V	65	65	100
mm ²		95	120	150	
		× 1800	× 1800	× 1800	
		30 / 6	30 / 6	30 / 6	
		550 / 45	550 / 45	805 / 55	



		TRACON						
		U _m	205A/AC-3	245A/AC-3	300A/AC-3	410A/AC-3	475A/AC-3	620A/AC-3
		24 V~	-	TR1E245B7	-	TR1E410B7	TR1E475B7	TR1E620B7
		48 V~	TR1E205E7	TR1E245E7	TR1E300E7	TR1E410E7	TR1E475E7	TR1E620E7
		230 V~	TR1E205	TR1E245	TR1E300	TR1E410	TR1E475	TR1E620
		400 V~	TR1E205V7	TR1E245V7	TR1E300V7	TR1E410V7	TR1E475V7	TR1E620V7
I_e (A)	AC-1	275	315	400	500	700	1000	
	AC-3	205	245	300	410	475	620	
P_e (kW)	AC-4	70	80	100	140	160	210	
	220/230 V	63	75	100	110	147	200	
	380/400 V	110	132	160	200	250	335	
	415 V	110	132	180	220	280	375	
	500 V	129	160	200	257	355	400	
	660/690 V	129	160	220	280	335	450	
		1000 V	100	147	160	185	335	450
mm ²		185	240	240	2×150	2×240	2×60×5 mm	
		× 1800	× 1800	× 1800	× 900	× 900	× 900	
		30 / 5	30 / 5	30 / 5	10 / 3	10 / 3	10 / 2	
		805 / 55	700 / 8	700 / 8	1150 / 12	1150 / 16	1730 / 20	

A TR1E típusú kontaktorok túláramvédelme az I/45. oldalon található!

Méretrajzok

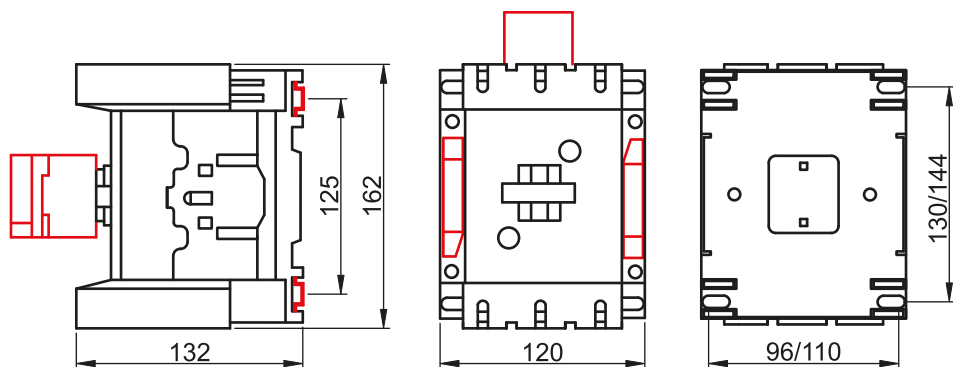

TR1E115 ... TR1E170

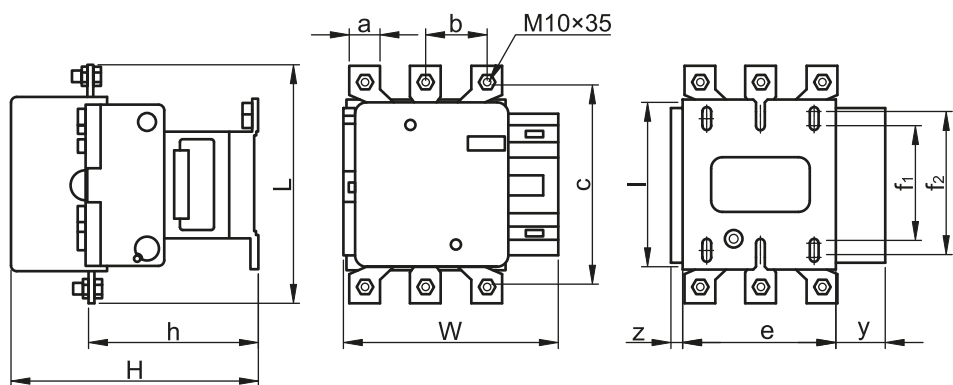

TR1E205 ... TR1E300

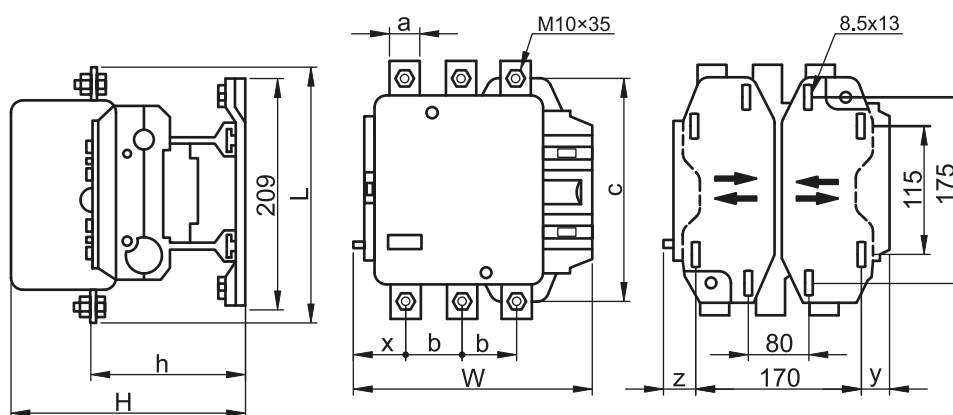

TR1E410, TR1E475

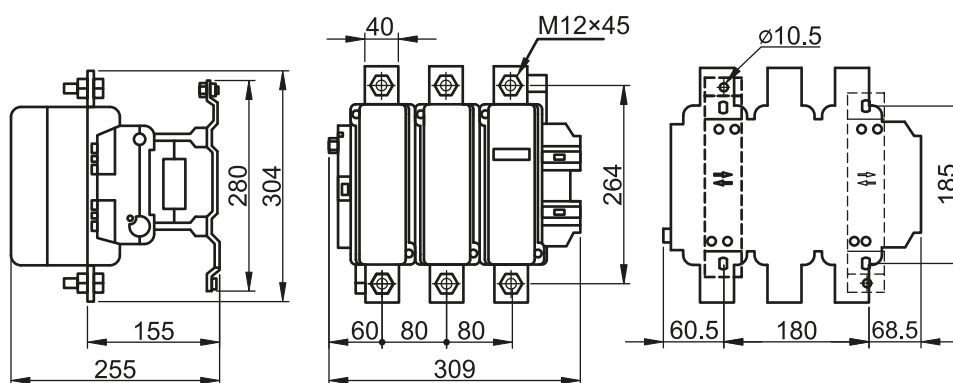

TR1E620



TRACON	W (mm)	H (mm)	L (mm)	a (mm)	b (mm)	c (mm)	l (mm)	e (mm)	x (mm)	f1 (mm)	f2 (mm)	h (mm)	y (mm)	z (mm)
TR1E205	170	181	175	20	40	156	137	80	-	106	120	114	44	15
TR1E245	170	182	196	25	48	172	137	80	-	106	120	113	44	15
TR1E300	215	217	205	25	48	180	145	96	-	110	122	145	38	20,5
TR1E410	215	222	205	25	48	180	-	-	45	-	-	148	23,5	15
TR1E475	235	225	235	30	55	210	-	-	43	-	-	140	44	15

Segédérintkező egységek

U_i 690 V	U_e 660 V	I_{th} 10 A	I_e 2 A	$\times 10^7$	AC 15	[mm ²] 1x1-2x2,5	10 A G	T_a -25...+50°C	IP 20
-------------------------------	-------------------------------	-------------------------------	-----------------------------	---------------	--------------	---------------------------------	--------	-------------------------------------	--------------

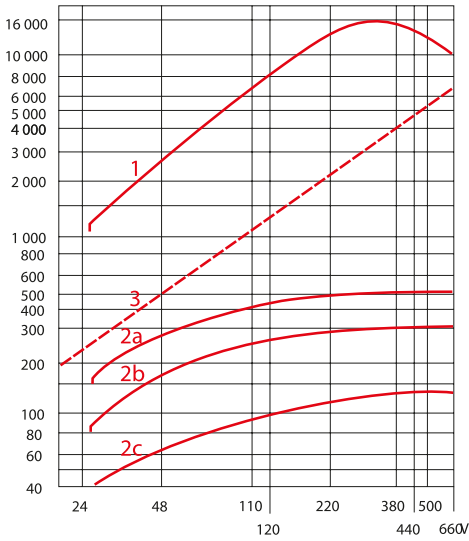

Villamos élettartam a kapcsolható teljesítmény függvényében (AC15)

	U _e						
	24 V	48 V	110 V 127 V	220 V 230 V	380 V 400 V	440 V	600 V
10⁶	150 VA	300 VA	400 VA	480 VA	500 VA	500 VA	500 VA
3×10⁶	80 VA	170 VA	250 VA	290 VA	320 VA	320 VA	320 VA
10⁷	30 VA	65 VA	90 VA	120 VA	130 VA	130 VA	130 VA

Jelmagyarázat

- 1: megszakítóképesség határa
- 2a: 10⁶ működési ciklus
- 2b: 3×10⁶ működési ciklus
- 2c: 10⁷ működési ciklus
- 3: melegedési határ

Homlokoldali segédérintkezők

TR1K kontaktorokhoz

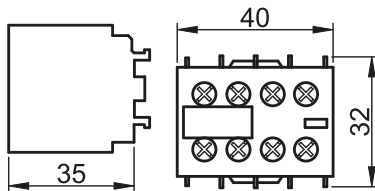

TRACON

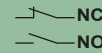

TR5KN02	2 × NC
TR5KN04	4 × NC
TR5KN11	1 × NO + 1 × NC
TR5KN13	1 × NO + 3 × NC
TR5KN20	2 × NO
TR5KN22	2 × NO + 2 × NC
TR5KN31	3 × NO + 1 × NC
TR5KN40	4 × NO



TR1D és TR1E kontaktorokhoz

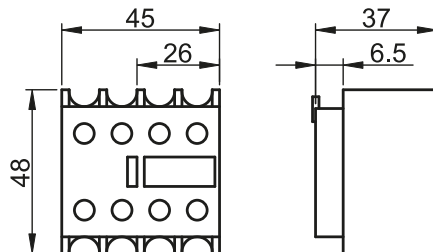

TRACON

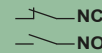

TR6DN02	2 × NC
TR6DN04	4 × NC
TR6DN11	1 × NO + 1 × NC
TR6DN13	1 × NO + 3 × NC
TR6DN20	2 × NO
TR6DN22	2 × NO + 2 × NC
TR6DN31	3 × NO + 1 × NC
TR6DN40	4 × NO



TR6-DN40
TR5-KN40

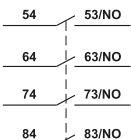

TR6-DN31
TR5-KN31

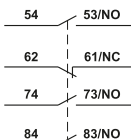

TR6-DN22
TR5-KN22

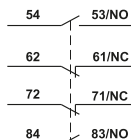

TR6-DN13
TR5-KN13

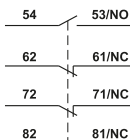

TR6-DN04
TR5-KN04

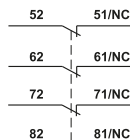

TR6-DN20
TR5-KN20

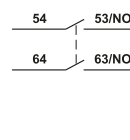

TR6-DN11
TR5-KN11

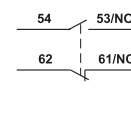

TR6-DN02
TR5-KN02

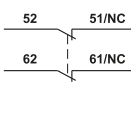

Oldalsó segédérintkező egységek TR1D09 ... TR1D65 és TR1E115..170 kontaktorokhoz

TRACON

NC
NO

TR8-DN20	2 × NO
TR8-DN11	1 × NC + 1 × NO

TR8-DN20

54 — 53/NO

64 — 63/NO

TR8-DN11

54 — 53/NO

62 — 61/NC



Időzítőegységek TR1D/E kontaktorokhoz

TRACON

NC
NO

on toff

TR7DT2	1 × NC + 1 × NO	0.1-30 s
TR7DR2	1 × NC + 1 × NO	0.1-30 s

TR7DR2

58 — 57/NO

66 — 65/NC

TR7DT2

56 — 55/NC

68 — 67/NO



Mechanikus reteszelő

TRACON

TR9-D09978	9-32 A
TR9-D50978	40-95 A

Két kontaktor közé építve megakadályozza azok egyidejű behúzását. Villamos reteszelés nélküli irányváltókban, segédkapcsolóval ellátott biztonsági kapcsolásban és csillag-háromszög összeállításban is alkalmazható.



TR9-D09978

9-32A-ig a két összekapcsolandó kontaktor közötti stabil kapcsolatot biztosító távtartóval érhetjük el, ami a kontaktor oldalán található horgonyzatba csúsztatható.

TR9-D50978

40-95A-ig a kontaktor alján lévő szerelőlapra csavarokkal rögzíthető segédcsín és az arra patintható távtartó biztosít megbízható kapcsolatot.

Termikus túláramvédelmi relék

A relé érintkezők villamos adatai

Piktogramok I/O

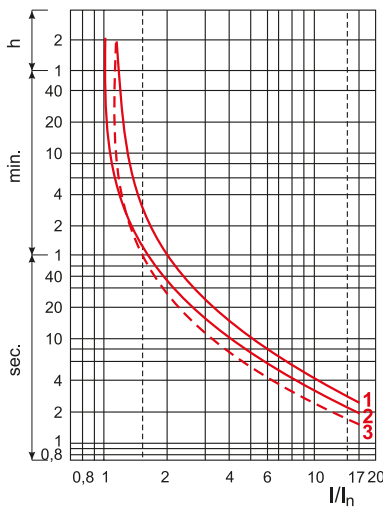

	U _e				
	24 V	48 V	110 V	230 V	400 V
P _e	100 VA	200 VA	400 VA	600 VA	600 VA

Jelmagyarázat

- 1:** 3 fázisú terhelés, hideg állapotból indulva
- 2:** 2 fázisú terhelés, hideg állapotból indulva
- 3:** 3 fázisú terhelés, hosszú időn keresztül tartó folyamatos terhelés esetén (meleg állapot)

A különféle villamos berendezésekben alkalmazott villamos motorok túlterhelés elleni védelmének korszerű eszköze a termikus túláramvédelmi relé (vagy hőrelé). A készülék működése ún. inverz jellegű, azaz minél nagyobb a motor áramkörében folyó áram, annál rövidebb idő alatt következik be a lekapcsolás.

A védőrelé bemenetétől szolgáló kör keresztmetszetű réz csapokat a kontaktor 2T1; 4T2 és 6T3 jelű csatlakozókapcsaihoz kell csatlakoztatni.

A hőrelé beállítását a homlokoldalon lévő - szükség esetén ólomzárolható - átlátszó takarólemez alatt elhelyezett beállító gombbal lehet végrehajtani. Ugyanitt helyezkedik el a reléáramkör megfelelő működésének ellenőrzésére szolgáló TEST nyomógomb, valamint a relé kézi- vagy automatikus visszaállításának kiválasztására szolgáló beállító szerv. A relé kikapcsolására használható vörös színű STOP gomb a fedélen kívül található.

A termikus túláramvédelmi relé egy nyitó (NC) és egy ettől villamosan független záró (NO) érintkezővel, továbbá a kioldott állapot jelzésére szolgáló optikai állásjelzővel is rendelkezik.

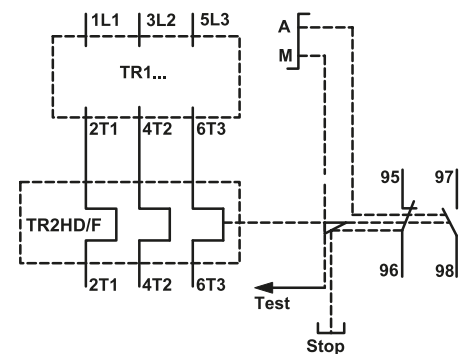

A: Automatikus visszaállítás
M: Kézi visszaállítás

TR1K kontaktorhoz

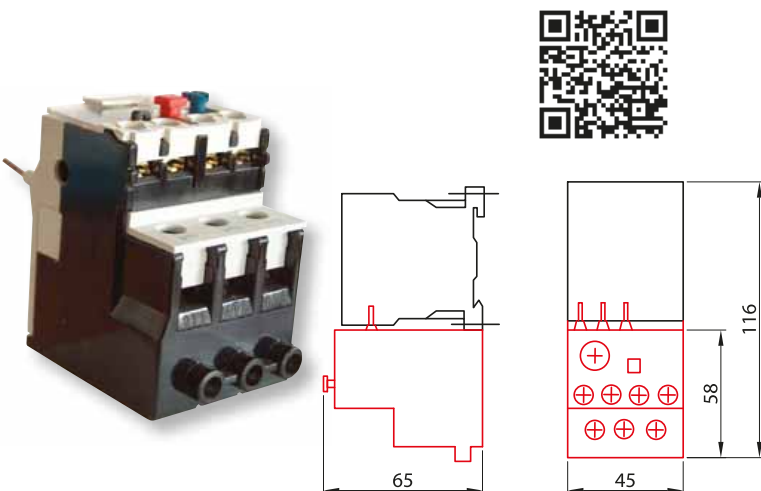

Piktogramok I/O



TRACON	l _{th}	mm ²	
TR2HK0301	0.1 – 0.16 A		
TR2HK0302	0.16 – 0.25 A		
TR2HK0303	0.25 – 0.4 A		
TR2HK0304	0.4 – 0.63 A		
TR2HK0305	0.63 – 1 A		
TR2HK0306	1 – 1.6 A		
TR2HK0307	1.6 – 2.5 A		
TR2HK0308	2.5 – 4 A		
TR2HK0310	4 – 6 A		
TR2HK0312	5.5 – 8 A		
TR2HK0314	7 – 10 A		
TR2HK0316	9 – 13 A		

1.5 – 4

TR1D kontaktorhoz

TRACON I_{th}  

TR2HD1304	0,4 – 0,63 A	2,5 – 10
TR2HD1305	0,63 – 1 A	
TR2HD1306	1 – 1,6 A	
TR2HD1307	1,6 – 2,5 A	
TR2HD1308	2,5 – 4 A	
TR2HD1310	4 – 6 A	
TR2HD1312	5,5 – 8 A	
TR2HD1314	7 – 10 A	
TR2HD1316	9 – 13 A	
TR2HD1321	12 – 18 A	
TR2HD1322	17 – 25 A	4 – 35
TR2HF2353	23 – 32 A	
TR2HF2355	28 – 36 A	
TR2HD3353	23 – 32 A	
TR2HD3355	30 – 40 A	
TR2HD3357	37 – 50 A	
TR2HD3359	48 – 65 A	
TR2HD3361	55 – 70 A	
TR2HD3363	63 – 80 A	
TR2HD3365	80 – 93 A	



U_i
690 V

U_{imp}
6 kV

0-400 Hz

T_a
-30...+55°C

IP
20

Class I_r
10A

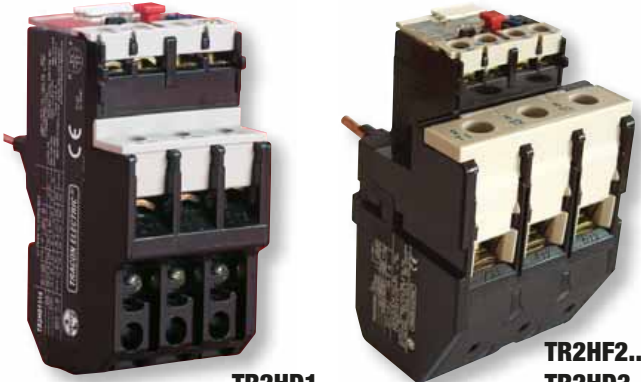
TR2HD1.. **TR2HF2..**
TR2HD3..

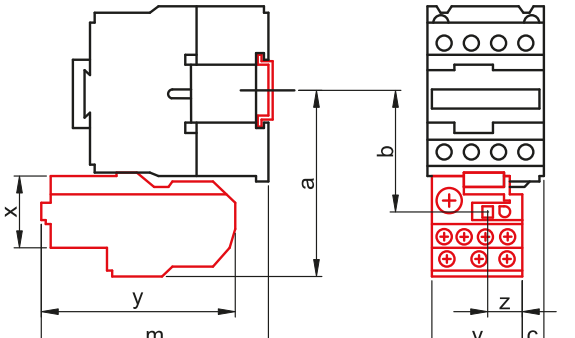

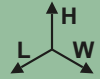

Diagram showing dimensions: x , y , m , a , b , v , z , c .

TRACON	a (mm)	b (mm)	c (mm)	m (mm)	x (mm)	y (mm)	v (mm)	z (mm)
TR1D09...D18	81	50	0	98	47	92	44	17
TR1D25	86	55	10.7	108	47	92	44	17
TR1D32	86	55	8.1	109	47	92	44	17
TR1D40...D65	111	72.4	4.5	119	54	109	70	30
TR1D80...D95	115.5	76.9	9.5	124	54	109	70	30

Adapter hőrelékhez

TRACON  

TR2AD1	TR2HD13..	46×78×86 mm
TR2AD3	TR2HF23.., TR2HD33..	73×103×120 mm

RELEVANT STANDARD
EN 60947-1

RELEVANT STANDARD
EN 60947-4-1

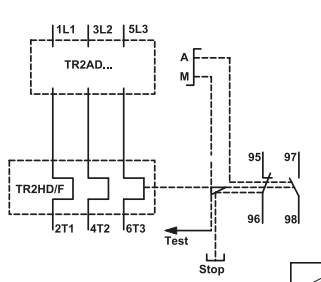

35×7.5



A: Automatikuss visszaállítás
M: Kézi visszaállítás

EVOHK Installációs kontaktorok





F/27



Kontaktorok és hőrelék összerendelése

Az alábbi táblázatok segédletet nyújtanak a védendő motorhoz használt kontaktornak és hőrelének a motor üzemi adatai alapján történő kiválasztásához és ezek kölcsönös összerendeléséhez. A táblázatban szereplő motorteljesítmény- és áram értékek a háromfázisú motor deltakapcsolásban való működtetésére vonatkoznak. Alkalmazási kategória: AC-3

TR1K segédkontaktor és hőrelé összerendelése

Pe (kW)	Ie (A)			I _{th}		
					aM	gG (gL)
–	0,1	TR1K06	TR2HK0301	0,1 – 0,16	1	2
0,06	0,16	TR1K06	TR2HK0302	0,16 – 0,25	1	2
0,08	0,25	TR1K06	TR2HK0303	0,25 – 0,4	1	2
0,1	0,4	TR1K06	TR2HK0304	0,4 – 0,63	2	4
0,3	1,0	TR1K06	TR2HK0305	0,63 – 1	2	4
0,4	1,0	TR1K06	TR2HK0306	1 – 1,6	2	4
0,8	2,0	TR1K06	TR2HK0307	1,6 – 2,5	4	6
1,1	2,6	TR1K06	TR2HK0308	2,5 – 4	6	10
1,5	3,5	TR1K06	TR2HK0308	2,5 – 4	6	10
2,2	5,0	TR1K06	TR2HK0310	4 – 6	10	16
3,0	6,3	TR1K06	TR2HK0312	5,5 – 8	10	16
4,0	8,5	TR1K09	TR2HK0314	7 – 10	10	20
5,0	11	TR1K12	TR2HK0316	9 – 13	16	25

TR1D kontaktor és hőrelé összerendelése

Pe (kW)	Ie (A)			I _{th}		
					aM	gG (gL)
0,1	0,4	TR1D09	TR2HD1304	0,4-0,63	2	4
0,3	1,0	TR1D09	TR2HD1305	0,63-1	2	4
0,4	1,0	TR1D09	TR2HD1306	1-1,6	2	4
0,8	2,0	TR1D09	TR2HD1307	1,6-2,5	4	6
1,1	2,6	TR1D09	TR2HD1308	2,5-4,0	6	10
1,5	3,5	TR1D09	TR2HD1308	2,5-4,0	6	10
2,2	5,0	TR1D09	TR2HD1310	4,0-6,0	10	16
3,0	6,3	TR1D09	TR2HD1312	5,5-8	10	16
4,0	8,5	TR1D09	TR2HD1314	7,0-10,0	10	20
5,0	11,0	TR1D12	TR2HD1316	9-13,0	16	25
7,5	15,5	TR1D18	TR2HD1321	12,0-18,0	20	35
9,0	18,0	TR1D18	TR2HD1321	12,0-18,0	25	35
11,0	22,0	TR1D25	TR2HD1322	17,0-25,0	25	50
15,0	32,0	TR1D32	TR2HF2353	23,0-32,0	40	63
15,0	32,0	TR1D32	TR2HF2355	28,0-36	50	63
18,0	40,0	TR1D40	TR2HD3353	23,0-32,0	40	63
18,0	40,0	TR1D40	TR2HD3355	30-40,0	50	63
22,0	44,0	TR1D50	TR2HD3357	37,0-50,0	63	80
25,0	57,0	TR1D65	TR2HD3359	48-65,0	80	100
30,0	60,0	TR1D65	TR2HD3361	55,0-70,0	80	100
37,0	72,0	TR1D80	TR2HD3363	63,0-80,0	80	125
45,0	93,0	TR1D95	TR2HD3365	80-93,0	100	125

Motorindító kombináció

A TR1D- ... - típusú kontaktorok, segédérintkezők, időzítő vagy időrelé, valamint hőrelé felhasználásával különböző kombinációk alakíthatók ki, így pl. a csillag-delta automata motorkapcsoló ill. motorindító. A rövid ismertető (FÜGGELÉK) tervezési segédletet nyújt a szükséges elemek összerendeléséhez, kapcsolási rajzuk, huzalozásuk, bekötési kialakításhoz.

A csillag-delta motorindító 3 kontaktorból, 2 segédérintkezőből, 1 időzítőegységből és 1 hőreléből áll.

Nagyáramú kontaktorokkal vezérelt villamos berendezések túláramvédelme

Ipari jellegű felhasználásra szánt, nagyáramú kontaktorokkal vezérelt villamos berendezések megbízható túláramvédelme rendszerint ún. túláramvédelmi kombináció segítségével, közvetett módon oldható meg. A túláramvédelmi kombináció érzékelő-működtető szerve fázisonként egy-egy 0-5 A áramtartományban állítható áramnövekedési védőrelé, amelyek áramérzékelő bemenetére az adott fázisba épített áramváltó szekunder tekercsét csatlakoztatjuk. Ha a fázisonkénti áramnövekedési védőrelék megfelelő segédérintkezői sorba vannak kapcsolva és bármely fázisáram értéke a beállított érték fölé emelkedik, a hibás fázis védőreléje gerjesztett állapotba kerül és bontja a nagyáramú kontaktor vezérlőáramkörét, biztosítva ezzel a berendezés túlárammal szembeni védelmét. Megjegyezzük, hogy ez a megoldás a motorvédelem szokásos jelleggörbéjét nem követi.

Csatlakozó kiosztás

L,N	Tápfeszültség
k;l	Áramváltó csatlakozói
1	NO záró érintkező
2	CO közös kontaktus
3	NC nyitó érintkező



Túláramvédelmi kombináció elemei

TRACON	Megnevezés	Darabszám	Oldal
TFKV-AKA05	Áramnövekedési védőrelé	3 db (fázisonként 1 db)	J/21
AVBS, AV...-SH	5A szekunder áramú kifestültségű áramváltó	3 db (fázisonként 1 db)	L/26

Megjegyzés

- A védőkészülék a motor bekapcsolásával járó indítási áramcsúcsot 0,5-8 s beállítható időtartományon belül nem veszi figyelembe.
- Ha a mért áramérték a beállított értéktől eltérő nagyságú, akkor a relé kimenete a beállított késleltetési idő végén állapotot fog váltani. Ha az áramváltó szekunder áramának értéke a beállított 0,5-15 s késleltetési időn belül visszaáll a beállított áramvédelmi szintre, akkor a relé kimenetének állapota nem változik meg.
- A háromfázisú hálózat egyéne fázisaihoz illeszkedő védőrelék időkésleltetés értékeit azonos értékre célszerű beállítani!

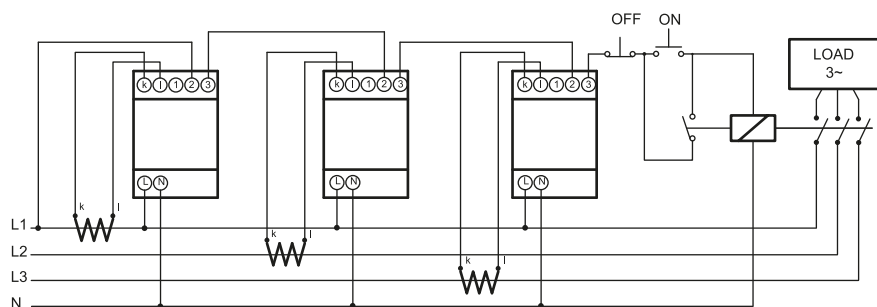

n	TRACON	I _{th} min	I _{th} max	I _{th} (A)					
				0,5	1	2	3	4	5
-	-	0,5 A	5 A	0,5 A	1 A	2 A	3 A	4 A	5 A
100/5A	TR1E115	10 A	100 A	10 A	20	40	60	80	100 A
120/5A	TR1E115	12 A	120 A	12 A	24	48	72	96	120 A
125/5A	TR1E150	12,5 A	125 A	12,5 A	25	50	75	100	125 A
150/5A	TR1E170	15 A	150 A	15 A	30	60	90	120	150 A
200/5A	TR1E205	20 A	200 A	20 A	40	80	120	160	200 A
250/5A	TR1E245	25 A	250 A	25 A	50	100	150	200	250 A
300/5A	TR1E300	30 A	300 A	30 A	60	120	180	240	300 A
400/5A	TR1E410	40 A	400 A	40 A	80	160	240	320	400 A
500/5A	TR1E475	50 A	500 A	50 A	100	200	300	400	500 A
600/5A	TR1E620	60 A	600 A	60 A	120	240	360	480	600 A
750/5A	-	75 A	750 A	75 A	150	300	450	600	750 A
800/5A	-	80 A	800 A	80 A	160	320	480	640	800 A
1000/5A	-	100 A	1000 A	100 A	200	400	600	800	1000 A
1500/5A	-	150 A	1500 A	150 A	300	600	900	1200	1500 A
2000/5A	-	200 A	2000 A	200 A	400	800	1200	1600	2000 A
2500/5A	-	250 A	2500 A	250 A	500	1000	1500	2000	2500 A
3000/5A	-	300 A	3000 A	300 A	600	1200	1800	2400	3000 A
4000/5A	-	400 A	4000 A	400 A	800	1600	2400	3200	4000 A
5000/5A	-	500 A	5000 A	500 A	1000	2000	3000	4000	5000 A

Kéziműködtetésű motorvédőkapcsolók

400 V AC	U_i 690 V	U_{imp} 6 kV	50/60 Hz	$\times 10^5$	$\times 10^5$	ON-OFF-ON... sc/h $\times 25$	AC 3		IP 20	T_a -25...+55°C	[mm²] 2x1-2x6	Class Ir 10A	P_m 2,5 VA AC
-----------------	-------------------------------	--------------------------------	----------	---------------	---------------	-------------------------------------	-------------	--	--------------	-------------------------------------	------------------------------------	-------------------------------	-----------------------------------

TRACON	I _e	P _e	I _m		
				aM (A)	gG (A)
TGV2-01	0,1 - 0,16 A	–	1,5 A	–	1
TGV2-02	0,16 - 0,25 A	0,06 kW	2,4 A	–	1
TGV2-03	0,25 - 0,4 A	0,09 kW	5 A	1	2
TGV2-04	0,4 - 0,63 A	0,18 kW	8 A	1	2
TGV2-05	0,63 - 1 A	0,37 kW	13 A	1	2
TGV2-06	1 - 1,6 A	0,55 kW	22,5 A	2	4
TGV2-07	1,6 - 2,5 A	0,75 kW	33,5 A	4	6
TGV2-08	2,5 - 4 A	1,5 kW	51 A	6	10
TGV2-10	4 - 6,3 A	2,2 kW	78 A	10	16
TGV2-14	6 - 10 A	4 kW	138 A	10	20
TGV2-16	9 - 14 A	5,5 kW	170 A	16	25
TGV2-20	13 - 18 A	7,5 kW	223 A	20	32
TGV2-21	17 - 23 A	11 kW	327 A	25	50
TGV2-22	20 - 25 A	11 kW	327 A	25	50
TGV2-32	24 - 32 A	15 kW	416 A	40	63

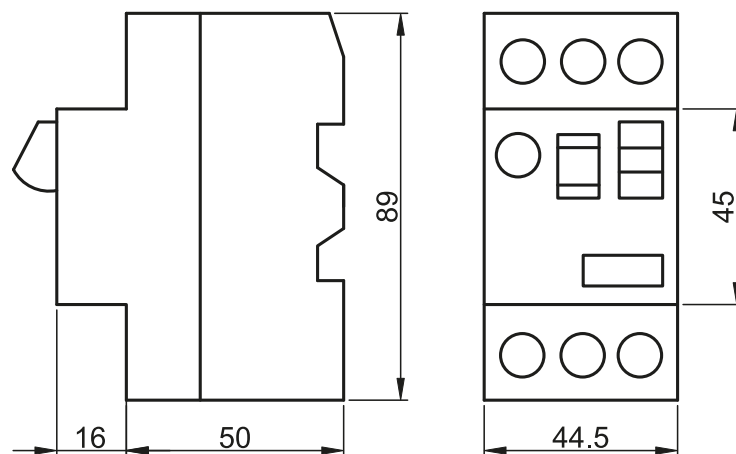

RELEVANT STANDARD
EN 60947-4-1

RELEVANT STANDARD
EN 60947-1



A készülékek háromfázisú terhelések, elsősorban egyedi villamos motorok be- és kikapcsolására, valamint túlterhelés elleni védelmére szolgálnak. A kioldás történhet mágneses működésű zárlati kioldóval vagy termikus túlterhelési kioldóval. Normál, kézzel működtethető mechanikus szerkezettel kapcsolható be-ki, és ki állásban lakatolható, egy a kapcsolókarból kihúzható műanyag retesszel. A védendő motor névleges üzemi áramát a készülék beállítási tartományán belül a homlokoldalon található forgatógombbal folyamatosan lehet állítani.

A motorvédőkapcsolók különböző tartozékokkal kiegészítve (hibajelzők, segédérintkezők, kioldók, tokozatok, stb.) távműködtetésre és különböző vezérlőberendezésekben történő felhasználásra tehetők alkalmassá.

Kioldási jelleggörbe

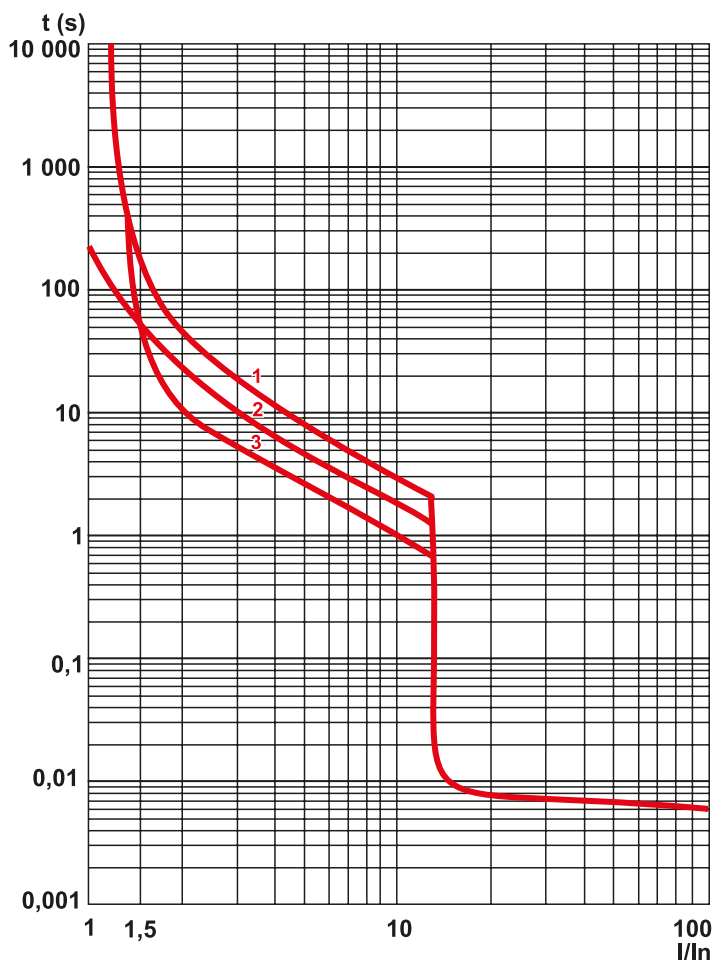

Jelmagyarázat

- 1:** 3 pólus hideg állapotból indulva
- 2:** 2 pólus hideg állapotból indulva
- 3:** 3 pólus meleg állapotból indulva

Áramkorlátozási jelleggörbe

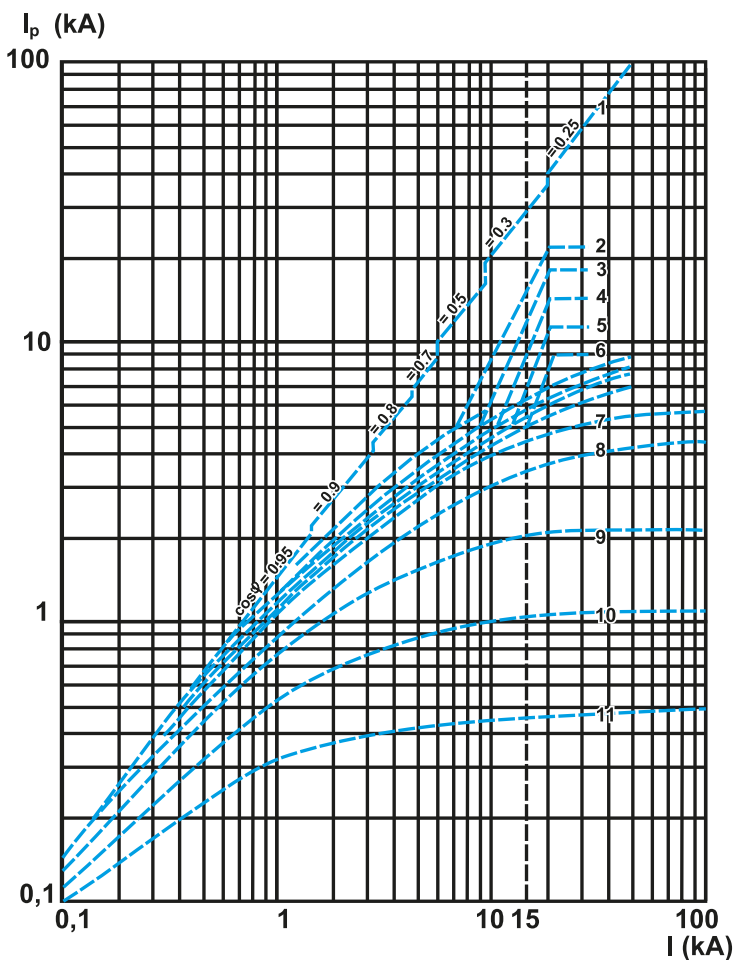

Jelmagyarázat

- | | | |
|----------------------|-------------------|----------------------|
| 1: I_{pmax} | 5: 13-18 A | 9: 2.5-4 A |
| 2: 24-32 A | 6: 9-14 A | 10: 1.6-2.5 A |
| 3: 20-25 A | 7: 6-10 A | 11: 1-1.6 A |
| 4: 17-23 A | 8: 4-6.3 A | |

Tartozékok

U_i 690 V	10 A gG	50/60 Hz	$\times 10^5$	P_m 5 VA	[mm ²] 0,75-2,5	P_m 5 VA AC
----------------	---------	----------	---------------	---------------	--------------------------------	------------------

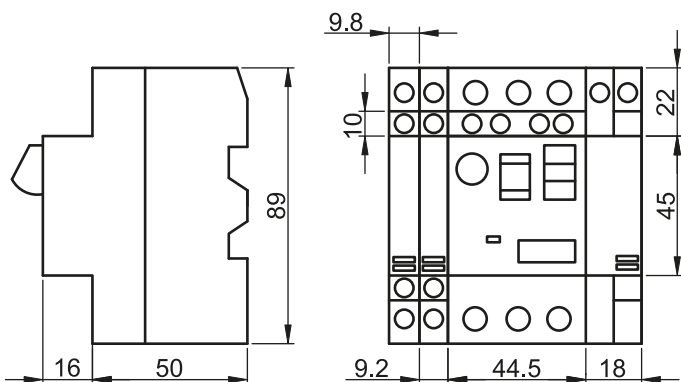

A motorvédőkapcsolók különböző tartozékokkal kiegészítve (hibajelzők, segédérintkezők, kioldók, tokozatok, stb.) távműködtetésre és különböző vezérlőberendezésekben történő felhasználásra tehető alkalmassá. A tokozatok használatával a motorvédőkapcsoló önálló alkalmazása is lehetséges, így védettségi fokozata IP 41, ill. IP 55-re növelhető.



Homlokoldali segédérintkezők

U_e (V)		24	48	60	230
I_e (A)	AC15	2	1,25	–	0,5
	DC13	1	0,3	0,15	–
I_{th} (A)		2,5 A			

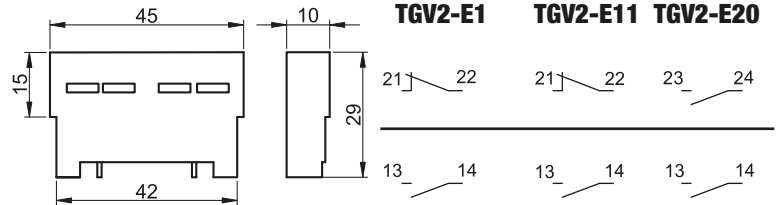
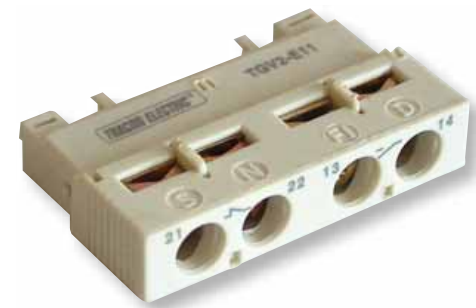

* Az érintkező nyitó vagy záró jellege az érintkezőegység behelyezésétől függ.

A motorvédőkapcsoló be- ill. kikapcsolt állapotáról adnak tájékoztatást. Segítségükkel lehetőség nyílik vezérlési, jelzési funkciók elvégzésére. A homlokoldali segédérintkező a készüléken található takarólemez eltávolítása után illeszthető a helyére.

Oldalsó segédérintkezők



U_e (V)		24	48	110	230	400
I_e (A)	AC15	–	6	4,5	3	2
	DC13	6	5	1,3	0,5	–
I_{th} (A)		6 A				

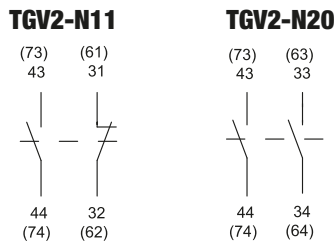

A motorvédőkapcsoló be- ill. kikapcsolt állapotáról adnak tájékoztatást. Segítségükkel lehetőség nyílik vezérlési, jelzési funkciók elvégzésére.

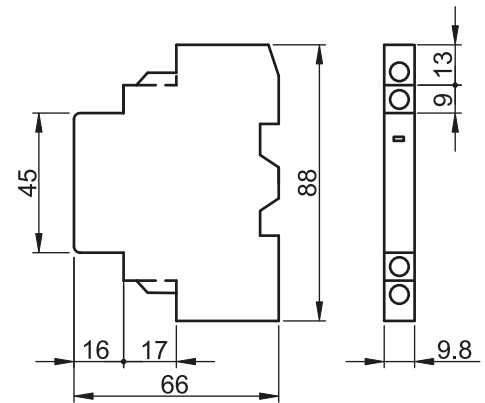

Zárlati kioldásjelző



U_e (V)		24	48	60
I_e (A)	AC15	1,5	1	–
	DC13	1	0,3	0,15
I_{th} (A)		2,5 A		

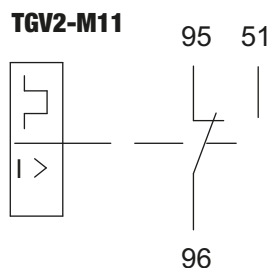

TRACON	
TGV2-M11	1×CO

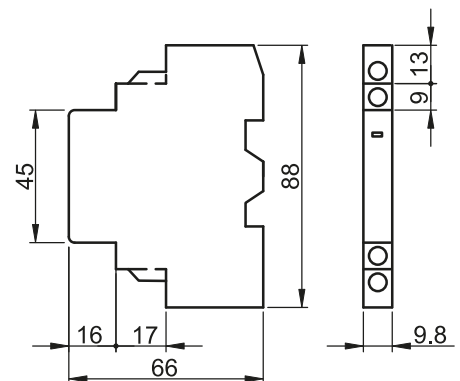

A védett motor meghibásodása esetén a hiba jellegéről (zárlat, túláram) adnak tájékoztatást.

Túlterhelési kioldásjelzők

TRACON	AUX	
TGV2-D1010	1×NO	1×NO
TGV2-D1001	1×NC	1×NO
TGV2-D0110	1×NO	1×NC
TGV2-D0101	1×NC	1×NC

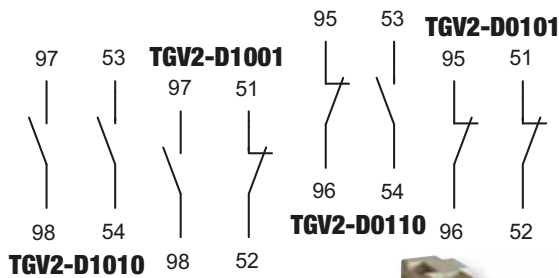

	AUX 						
U _e (V)	24	48	60	24	48	230	400
I _e (A)	AC15	1.5	1	-	-	6	3
	DC13	1	0.3	0.15	6	5	0.5
I _{th} (A)	2,5 A			6 A			

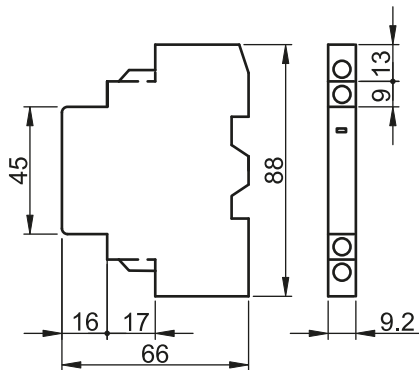

Feszültségcsökkenési kioldók (UVR)

TRACON	U _m	P _m
TGV2-U225	220-240 V AC	max. 5 VA
TGV2-U385	400-415 V AC	max. 5 VA

A feszültségcsökkenési kioldó a védőkapcsolót kioldja és visszakapcsolását megakadályozza, ha működtető feszültségének értéke a névleges érték 35 - 70 %-a közé csökken.

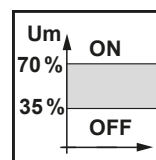
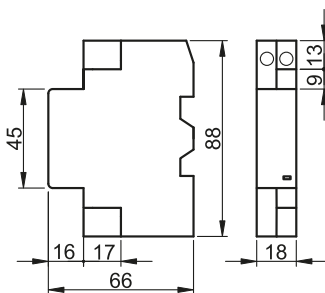
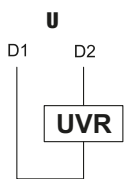

Munkaáramú kioldók (SHT)

TRACON	U _m	P _m
TGV2-S225	220-240 V AC	max. 5 VA
TGV2-S385	400-415 V AC	max. 5 VA

A munkaáramú (shunt) kioldó a védőkapcsoló kioldását idézi elő, ha tekercsére a névleges működtető feszültségének 70 - 110 %-át kapcsoljuk. Ezáltal teljesíti távműködtetési funkcióját.

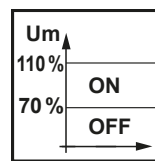
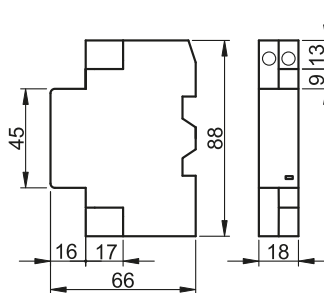
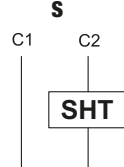

Tokozatok

TRACON	IP..
TGV2-T1	IP 41
TGV2-T2	IP 55

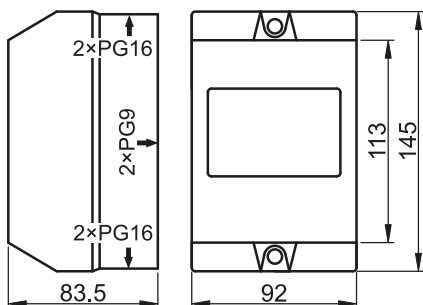

TGV2-T1

TGV2-T2

Táblázat fejlécek piktogramjai

U_m 	Névleges működtető feszültség	I_{up} 	Felső áramvédelmi szint	U_h 	Hiszterézis feszültség	I_e 	Névleges üzemi áram
U_{up} 	Felső feszültségvédelmi szint	A 	Beállítási tartomány (asszimétriá)	U_{down} 	Alsó feszültségvédelmi szint	I_{down} 	Alsó áramvédelmi szint
L1 L2 L3 	Fázissorrend figyelés	xP 	Pólusszám	m 	Tömeg		
	Reléfoglalat	VDC VAC A 	Érintkezők villamos adatai				

Műszaki adatok piktogramjai

U_{test} 1min 1,5 kV	Próbafezültség	 U_i 400 V	Névleges szigetelési feszültség	I_e (AC 1, 230 V) 10 A	Névleges üzemi áram	P_m 4 VA AC	Saját teljesítményfelvétel
TEST 	Teszt gomb	0 10  ha %	Pontossági osztály	 x10⁵	Villamos élettartam	 x10⁶	Mechanikus élettartam
	Forgókapcsoló	R_{OFF} PTC 1600-2000 Ω	Kikapcsolási ellenállás (PTC)	R_{ON} PTC 1000-1400 Ω	Bekapcsolási ellenállás (PTC)	 2xCO	Segédérintkezők
R max. 50 mΩ	Ellenállás	T_o  -20..+80°C	Üzemi hőmérséklet	T_a  -5..+40 °C	Környezeti hőmérséklet	IP 20	Védettségi fokozat
[mm²]  1-2,5	Beköthető vezeték	 35x7.5	Szerelősínre szerelhető				

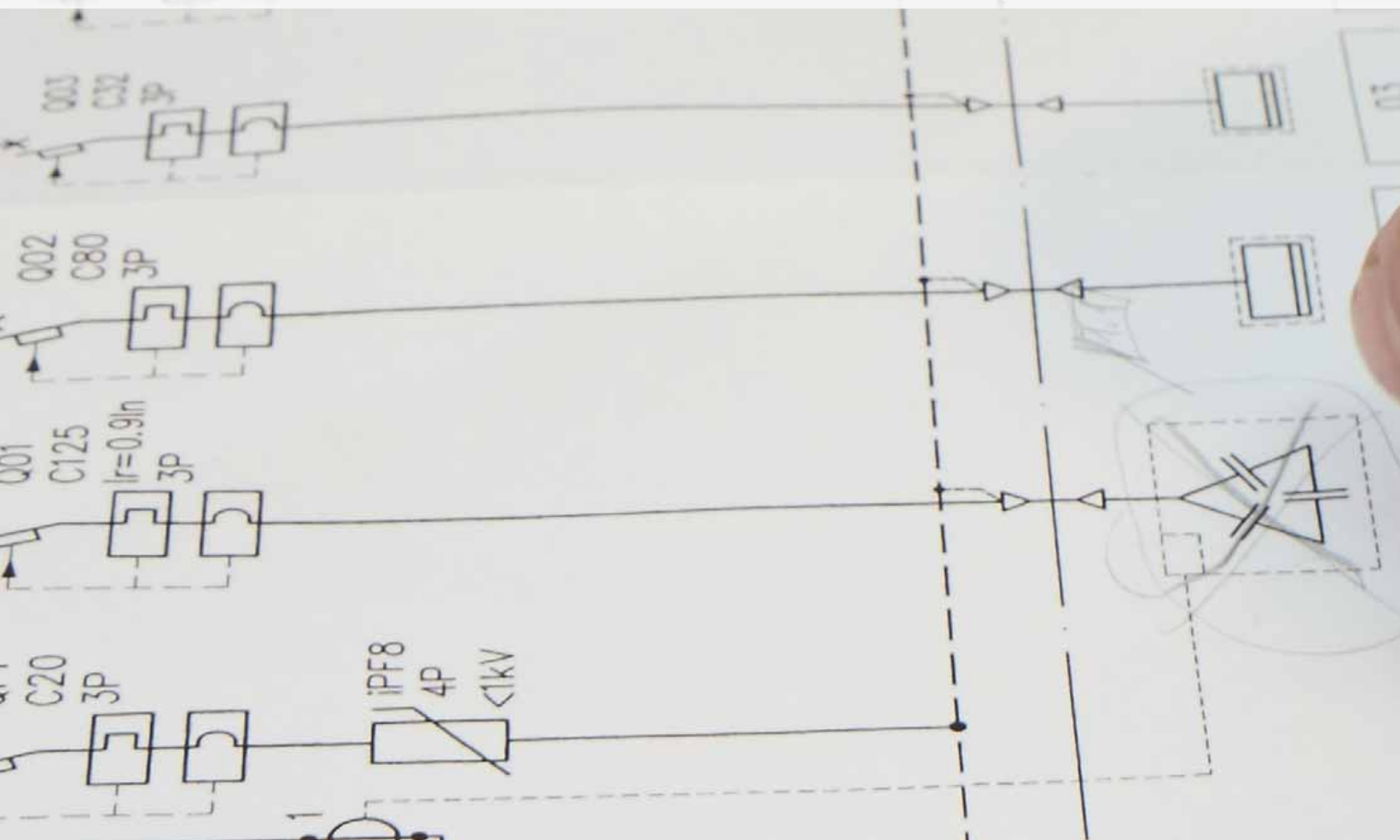



Ipari automatizálási relék **2**



Miniatúr relék **3**



Ipari teljesítményrelék **4**



Nagyteljesítményű relék **5**



Miniatúr teljesítményrelék **6**



Print relék **7**

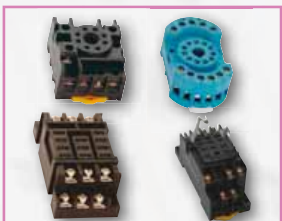

Reléfoglalatok **8**



Egyfunkciós (meghúzás-késleltetési) időrelé **11**



Egyfunkciós (elengedés-késleltetési) időrelé **11**



Elegendéskésleltetési tápfeszültség vezérelt időrelé **12**



Csillag-delta időrelé **12**



Multifunkciós időrelé (10 funkció) **13**



Lépcsőházi időkapcsoló **14**



Feszültségfigyelő relé **15**



Feszültségfigyelő relé 1 fázisra **16**



Feszültségfigyelő relé 3 fázisra **17**



Feszültségfigyelő relé 3 fázisra, beállítható aszimmetriával és túlmegengedés elleni védelemmel **18**



Feszültségfigyelő relé 3 fázisra, nullavezető nélküli hálózatokban **19**



Kompakt feszültségfigyelő relé beállítható időkésleltetéssel **20**



Áramcsökkenés és áramnövekedés elleni védelmi relék **21**



Ipari automatizálási relék

I_e (AC 1, 230 V) 3 A	P_m 2,5 VA AC	P_m 1,5 W DC	U_{test} 1min 1,5 kV	U_i 400 V	R max. 50 mΩ	x10⁷	x10⁵	TEST	T_a -40...+55°C	Piktogramok	J/0
--	-----------------------------------	----------------------------------	--	--------------------------------------	---------------------------	------------------------	------------------------	-------------	-------------------------------------	--------------------	------------

2 váltóérintkezős (2 × C0)

TRACON	U _m	VDC VAC	A		
RM08-240AC	AC 230 V				
RM08-110AC	AC 110 V				
RM08-48AC	AC 48 V				
RM08-24AC	AC 24 V		3 A		
RM08-12AC	AC 12 V	230 V AC		75 g	RS90.22
RM08-110DC	DC 110 V	28 V DC			
RM08-48DC	DC 48 V				
RM08-24DC	DC 24 V				
RM08-12DC	DC 12 V				

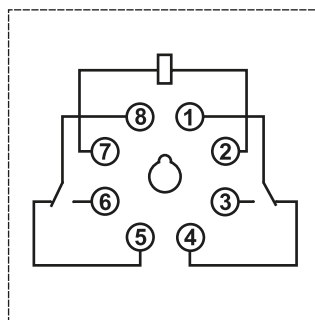

RM08

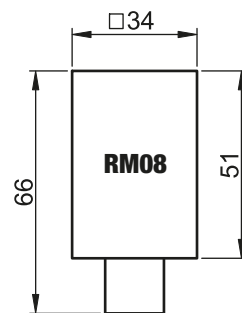

RELEVANT STANDARD
EN 61810

3 váltóérintkezős (3 × C0)

TRACON	U _m	VDC VAC	A		
RM11-220AC	AC 230 V				
RM11-110AC	AC 110 V				
RM11-48AC	AC 48 V				
RM11-24AC	AC 24 V		3 A		
RM11-12AC	AC 12 V	230 V AC		75 g	PF11-3A
RM11-110DC	DC 110 V	28 V DC			RS90.23
RM11-48DC	DC 48 V				
RM11-24DC	DC 24 V				
RM11-12DC	DC 12 V				

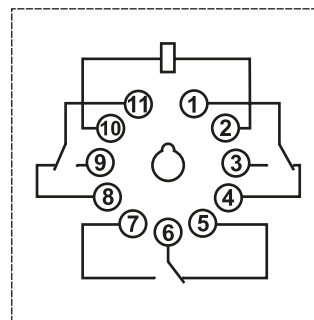

RM11

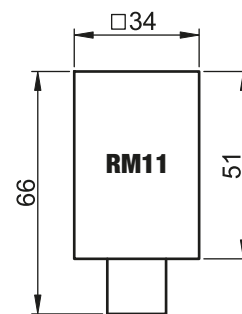

RM08

RM11

A relék átlátszó porvédő burával védettek, dugaszolható kivitelűek. 2 vagy 3 váltóérintkezővel rendelkeznek, csatlakozásuk körben elhelyezett 8 vagy 11 lábás dugaszoló csatlakozóval – a megadott reléfoglalatokkal – lehetséges. Rendelkeznek „TEST” gombbal, amelynek segítségével az érintkezők által kapcsolni kívánt áramkörök megfelelő működése ellenőrizhető.

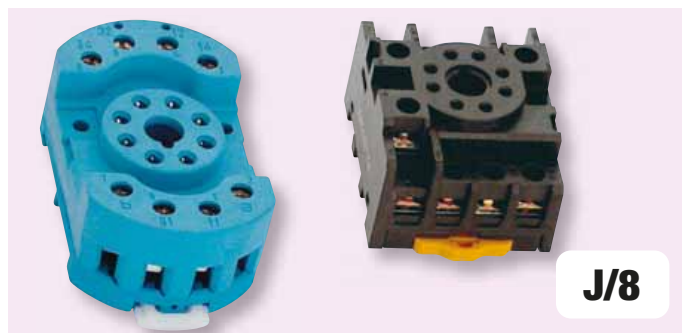

J/8



OLVASSA BE A KÓDOT!

- Nézze meg újdonságainkat
- Legyen naprakész

**Kínálatunk gyorsan és folyamatosan fejlődik!
Katalógusunk a 2021. áprilisi állapotot tükrözi.**

**Naprakész információért
látogasson el honlapunkra!**

Miniatúr relék

I_e (AC 1, 230 V)
3 A

P_m
1,2 VA AC

P_m
0,9 W DC

U_{test}
1min
1,5 kV

U_i
250 V

R
max.
50 mΩ

TEST
x10⁷

TEST
x10⁵

TEST

T_a
-40...+55°C



Piktogramok

J/0

2 váltóérintkezős (2 × C0)

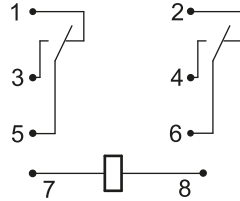
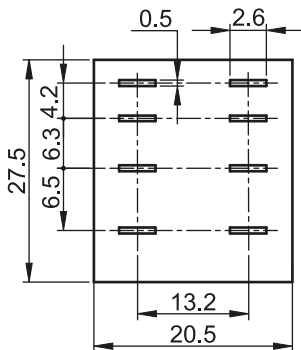

TRACON	U _m	VDC VAC	A	m	
RM09-240AC	AC 230 V				
RM09-110AC	AC 110 V				
RM09-48AC	AC 48 V				
RM09-24AC	AC 24 V				
RM09-12AC	AC 12 V	3 A	230 V AC	35 g	RSPYF-08A
RM09-110DC	DC 110 V		28 V DC		
RM09-48DC	DC 48 V				
RM09-24DC	DC 24 V				
RM09-12DC	DC 12 V				

3 váltóérintkezős (3 × C0)

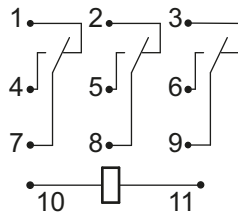
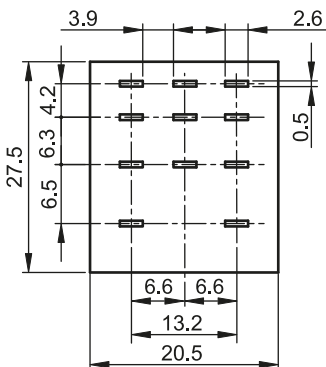

TRACON	U _m	VDC VAC	A	m	
RM12-240AC	AC 230 V				
RM12-110AC	AC 110 V				
RM12-48AC	AC 48 V				
RM12-24AC	AC 24 V				
RM12-12AC	AC 12 V	3 A	230 V AC	35 g	RSPYF-11A
RM12-110DC	DC 110 V		28 V DC		
RM12-48DC	DC 48 V				
RM12-24DC	DC 24 V				
RM12-12DC	DC 12 V				

4 váltóérintkezős (4 × C0)

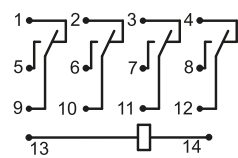
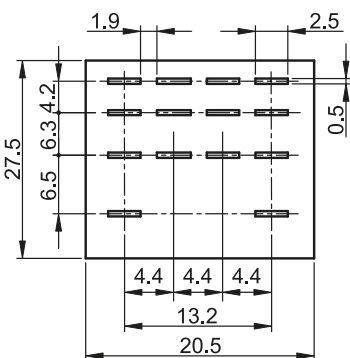

TRACON	U _m	VDC VAC	A	m	
RM14-220AC	AC 230 V				
RM14-110AC	AC 110 V				
RM14-48AC	AC 48 V				
RM14-24AC	AC 24 V				
RM14-12AC	AC 12 V	3 A	230 V AC	35 g	PYF14A RSPMF-14
RM14-110DC	DC 110 V		28 V DC		
RM14-48DC	DC 48 V				
RM14-24DC	DC 24 V				
RM14-12DC	DC 12 V				

A relék két, három vagy négy váltóérintkezőjűek, csatlakozásuk 8, 11 vagy 14 lábás dugaszoló csatlakozóval – a megadott reléfoglalatokkal – lehetséges. Ezek a kivitelek „TEST” gombbal rendelkeznek, amelynek működtetésével az érintkezők által kapcsolni kívánt áramkörök megfelelő működése ellenőrizhető.

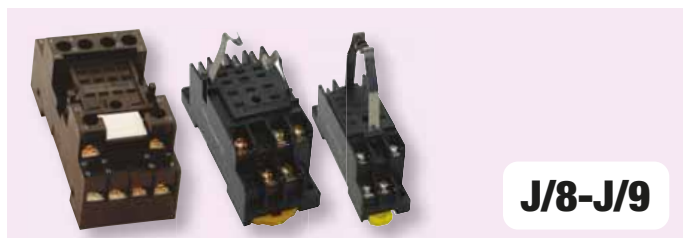

J/8-J/9

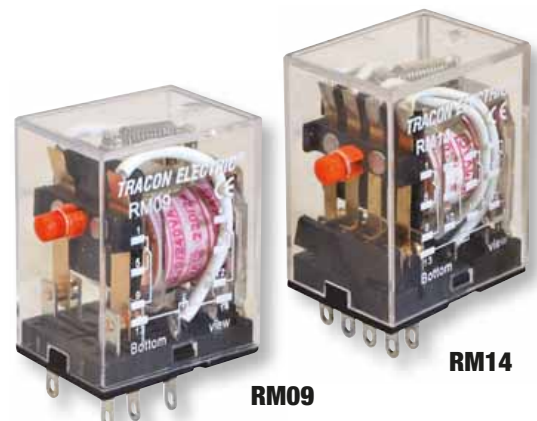
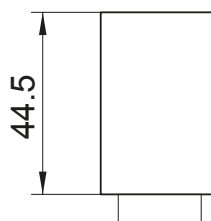

RM09

RM14

Ipari teljesítményrelék

I_e (AC 1, 230 V) 10 A	P_m 3,5 VA AC	P_m 2 W DC	U_{test} 1min 1,5 kV	U_i 400 V	R max. 50 mΩ	x10⁷	x10⁵	TEST	T_a -40..+55°C	Piktogramok	J/0
---	-----------------------------------	--------------------------------	--	--------------------------------------	---------------------------	------------------------	------------------------	-------------	------------------------------------	--------------------	------------

2 váltóérintkezős (2 × C0)

TRACON	U _m	VDC VAC	A	m	
RT08-240AC	AC 230 V				
RT08-110AC	AC 110 V				
RT08-48AC	AC 48 V				
RT08-24AC	AC 24 V		10 A		
RT08-12AC	AC 12 V	230 V AC		80 g	RS90.22
RT08-110DC	DC 110 V	28 V DC			
RT08-48DC	DC 48 V				
RT08-24DC	DC 24 V				
RT08-12DC	DC 12 V				

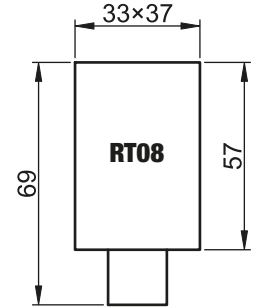
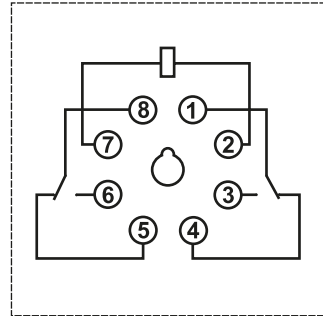

RT08

3 váltóérintkezős (3 × C0)

TRACON	U _m	VDC VAC	A	m	
RT11-240AC	AC 230 V				
RT11-110AC	AC 110 V				
RT11-48AC	AC 48 V				
RT11-24AC	AC 24 V		10 A		
RT11-12AC	AC 12 V	230 V AC		80 g	RS90.23
RT11-110DC	DC 110 V	28 V DC			PF11-3A
RT11-48DC	DC 48 V				
RT11-24DC	DC 24 V				
RT11-12DC	DC 12 V				

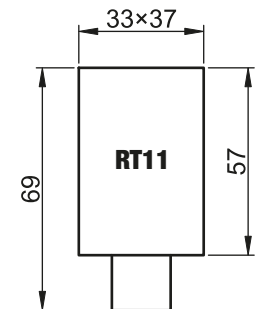
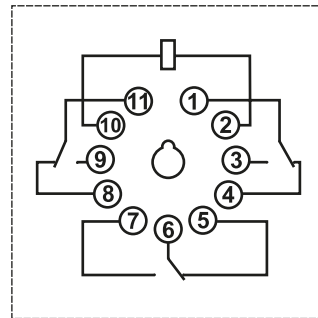

RT11



RT08



RT11



RELEVANT STANDARD
EN 61810-1

A relék két vagy három váltóérintkezővel, valamint LED diódás és mechanikus állásjelzővel rendelkeznek. A LED dióda a működtető-tekerccs gerjesztett állapotát, a mechanikus állásjelző az érintkezők átváltott (bekapcsolt) állapotát jelzi. A relé homloklapján található „TEST” kar segítségével az érintkezők a tekerccs gerjesztett állapotának megfelelő helyzetbe állíthatók. A kar az RM típusok „TEST” gombjával ellentétben, bekapcsolt állapotban tartja az érintkezőket mindaddig, amíg a kart alaphelyzetbe vissza nem állítjuk. A működtető tekerccsel párhuzamosan kapcsolt ellenállás-LED-dióda tag a tekerccs áramkörének kikapcsolásakor az esetlegesen fellépő feszültségcsúcsokat eltünteti, hogy azok ne okozzanak működési zavarokat az elektronikus működtető áramkörben.

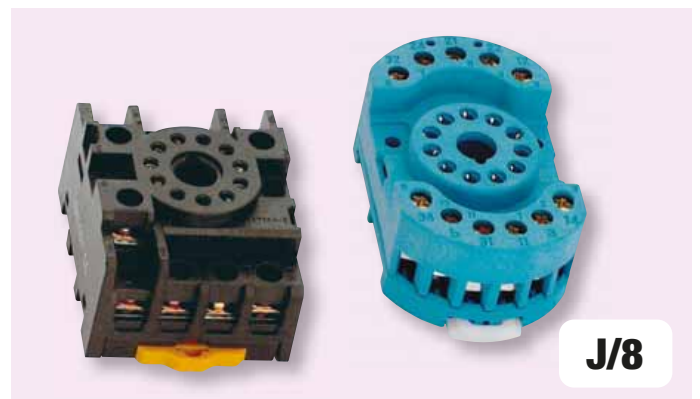

J/8

Nagyteljesítményű relék

I_e (AC 1, 230 V)
30 A

P_m
4 VA AC

P_m
2,5 W DC

U_{test}
1 min
2,5 kV

U_i
400 V

R
max.
50 mΩ

⚡
×10⁶

⚡
×10⁵

T_a
-40...+55°C

6,3×0,8 mm

Piktogramok **J/0**

2 váltóérintkezős (2 × C0)

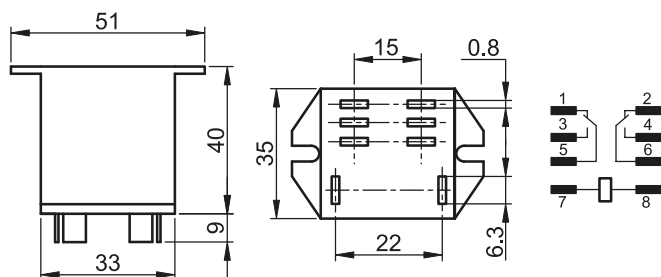

TRACON	U _m	VDC VAC	A	m	
RJ08-240AC	AC 230 V				
RJ08-110AC	AC 110 V				
RJ08-48AC	AC 48 V				
RJ08-24AC	AC 24 V				
RJ08-12AC	AC 12 V				
RJ08-110DC	DC 110 V				
RJ08-48DC	DC 48 V				
RJ08-24DC	DC 24 V				
RJ08-12DC	DC 12 V				
		30 A	230 V AC	130 g	-
		25 A	28 V DC		

3 váltóérintkezős (3 × C0)

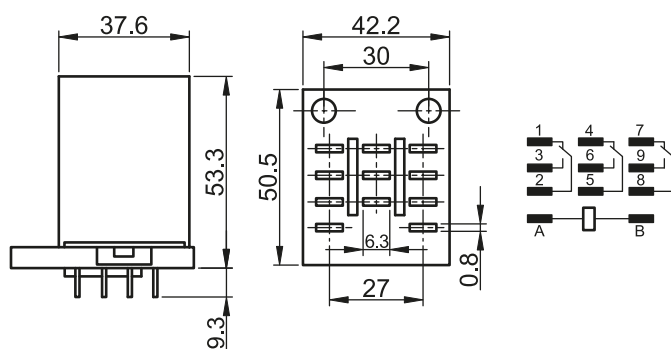

TRACON	U _m	VDC VAC	A	m	
RJ11-240AC	AC 230 V				
RJ11-110AC	AC 110 V				
RJ11-48AC	AC 48 V				
RJ11-24AC	AC 24 V				
RJ11-12AC	AC 12 V				
RJ11-110DC	DC 110 V				
RJ11-48DC	DC 48 V				
RJ11-24DC	DC 24 V				
RJ11-12DC	DC 12 V				
		40 A	120 V AC	130 g	RSJQX-38FS
		30 A	230 V AC		
		25 A	28 V DC		

Az RJ típusú nagyteljesítményű relék két vagy három váltóérintkezővel vannak szerelve. A nagyméretű érintkezők nagy áramok vezetésére és kapcsolására teszik a készüléket alkalmassá. A három érintkezős változat a csavaros csatlakozókapcsokkal rendelkező RSJQX-38FS rendelési kódú reléaljzatba dugaszolható, vagy 6,3×0,8 mm méretű rátolható hüvellyel húzalozható. Ekkor az alaplemezbe sajtolt menetek felhasználásával, M4 csavarokkal lehet a relét a szerelőlapon készített kivágásnál rögzíteni (ld. méretrajz).

A kétérintkezős változatot csavarokkal lehet a szerelőlapra rögzíteni, a húzalozásra 6,3×0,8 mm-es rátolható csatlakozó hüvelyeket kell használni.



J/9

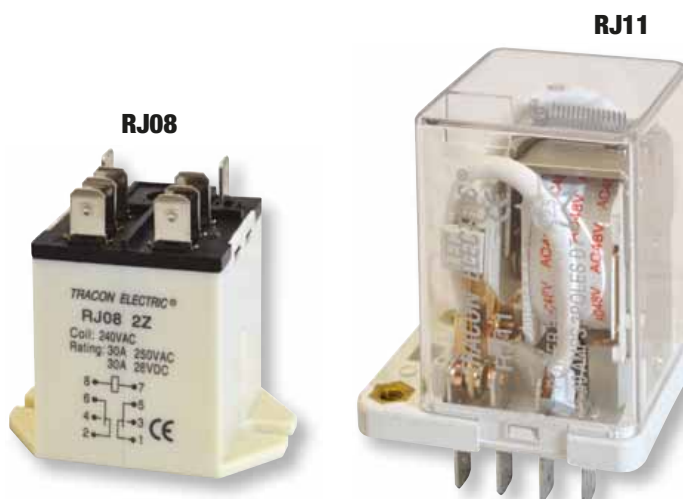

RELEVANT STANDARD
EN 61810-1



Miniatűr teljesítményrelék

I_e (AC 1, 230 V)
10 A

P_m
2,5 VA AC

P_m
1,5 W DC

U_{test}
1min
1 kV

U_i
250 V

R
max.
50 mΩ

x10⁷

x10⁵

T_a
-40...+55°C



Piktogramok

J/0

2 váltóérintkezős (2 × C0)

TRACON	U _m	VDC VAC	A	m	
RL08-240AC	AC 230 V				
RL08-110AC	AC 110 V				
RL08-48AC	AC 48 V				
RL08-24AC	AC 24 V		10 A		
RL08-12AC	AC 12 V	230 V AC		50 g	RSPTF-08A
RL08-110DC	DC 110 V	24 V DC			
RL08-48DC	DC 48 V				
RL08-24DC	DC 24 V				
RL08-12DC	DC 12 V				

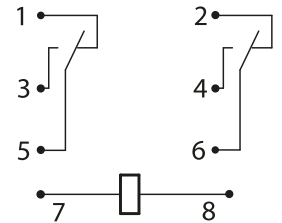
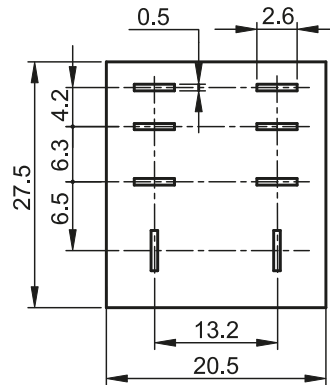

3 váltóérintkezős (3 × C0)

TRACON	U _m	VDC VAC	A	m	
RL11-240AC	AC 230 V				
RL11-110AC	AC 110 V				
RL11-48AC	AC 48 V				
RL11-24AC	AC 24 V		10 A		
RL11-12AC	AC 12 V	230 V AC		50 g	RSPTF-11A
RL11-110DC	DC 110 V	24 V DC			
RL11-48DC	DC 48 V				
RL11-24DC	DC 24 V				
RL11-12DC	DC 12 V				

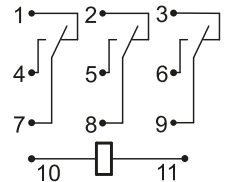
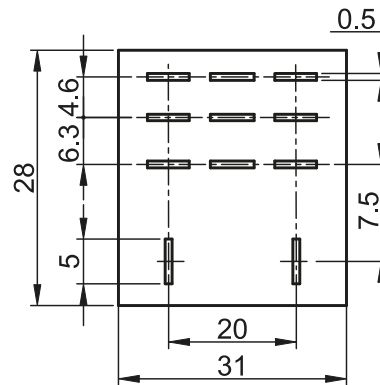

4 váltóérintkezős (4 × C0)

TRACON	U _m	VDC VAC	A	m	
RL14-240AC	AC 230 V				
RL14-110AC	AC 110 V				
RL14-48AC	AC 48 V				
RL14-24AC	AC 24 V		10 A		
RL14-12AC	AC 12 V	230 V AC		50 g	RSPTF-14A
RL14-110DC	DC 110 V	24 V DC			
RL14-48DC	DC 48 V				
RL14-24DC	DC 24 V				
RL14-12DC	DC 12 V				

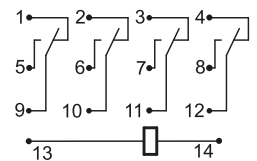
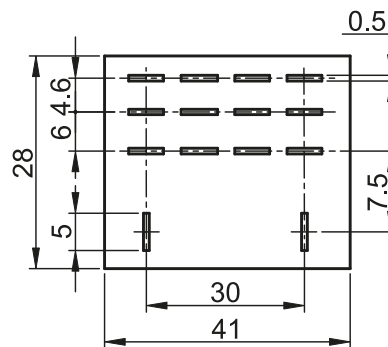

RL08



RL14

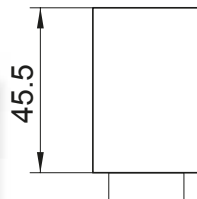

J/9

Print relék

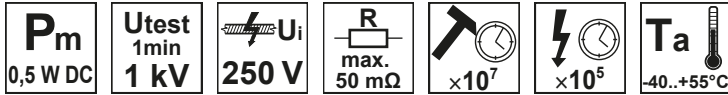

1 váltóérintkezős 10 A-es (1 × C0)

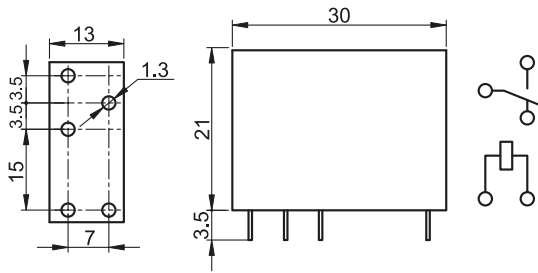

TRACON	U _m	VDC VAC	A	m	RSPSF-08AE
PR110-1V10A	110 V DC				
PR48-1V10A	48 V DC	10 A		50 g	
PR24-1V10A	24 V DC	230 V AC			
PR12-1V10A	12 V DC	30 V DC			

2 váltóérintkezős 5 A-es (2 × C0)

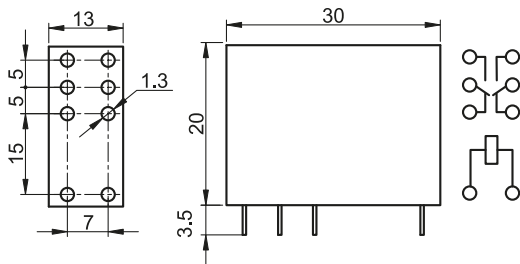

TRACON	U _m	VDC VAC	A	m	RSPSF-14AE
PR110-2V	110 V DC				
PR48-2V	48 V DC	5 A		50 g	
PR24-2V	24 V DC	230 V AC			
PR12-2V	12 V DC	30 V DC			

1 váltóérintkezős 16 A-es (1 × C0)

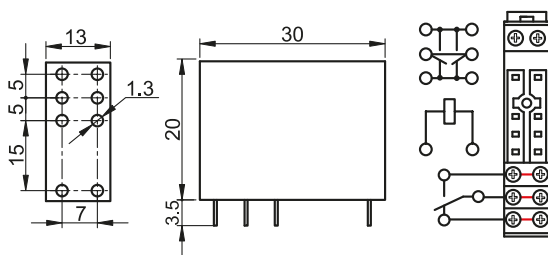

TRACON	U _m	VDC VAC	A	m	RSPSF-14AE
PR110-1V16A	110 V DC				
PR48-1V16A	48 V DC	16 A		50 g	
PR24-1V16A	24 V DC	230 V AC			
PR12-1V16A	12 V DC	30 V DC			

A 16 A-es változatoknál a váltóérintkezők megfelelő kapcsait párhuzamosan kell kötni, bekötési ábra szerint!

Az ún. print reléket elsősorban elektronikus vezérlések nyomtatott áramköri lemezeibe történő beültetésre tervezték. Ilyen alkalmazás lehet pl. kazánautomatika, házi vízellátó berendezés, házi uszoda vízforgató és szinttöltő berendezés, automata mosógép, stb. A relék konstrukciója és kivitele olyan, hogy alkalmasak az érintésvédelmi védőelválasztásra is. A relék a működtető tekercs és az érintkezők között az 1 percig tartó 4000 V-os villamos szilárdságvizsgálatnak is megfelelnek, és teljesítik az aktív részek és a működtető tekercs közötti 8 mm-es kúszóáramút és léghöz előírást.

A relék a nyomtatott áramköri lapon való, forrasztással történő alkalmazáson kívül a szokásos sínre rögzíthető, csavaros csatlakozókapcsokkal ellátott dugaszolóaljzattal is alkalmazhatók. A relék 1 vagy 2 váltóérintkezővel rendelkeznek.

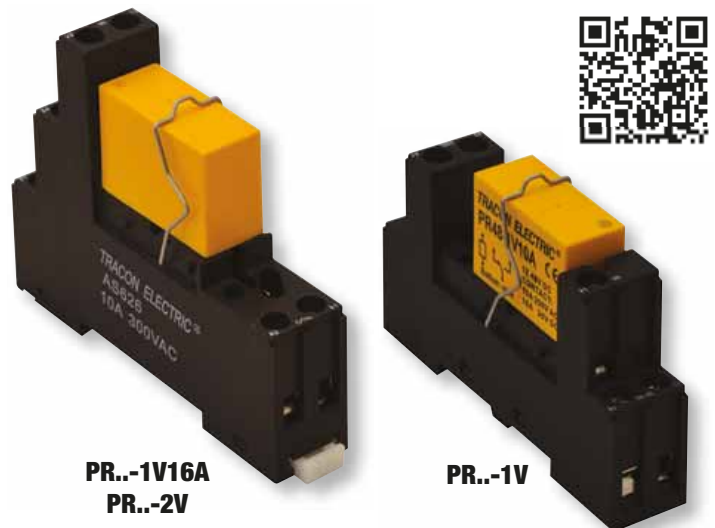

J/8

RELEVANT STANDARD
EN 61810-1



Reléfoglalatok

A reléfoglalatok szerelőlemezekre csavarozhatók vagy 35×7 mm méretű EN 50022 szerinti szerelősínre rögzíthetők, csavaros csatlakozókapcsokkal rendelkeznek, amelyhez min. 1 db 0,5 mm², illetve maximum 2 db 1,0 mm² vagy 1 db 1,5 mm² keresztmetszetű rézvezeték csatlakoztatható.

A reléfoglalatok tartozéka a reléket helyzetükben rögzítő rugózó elem!



TRACON PF11-3A

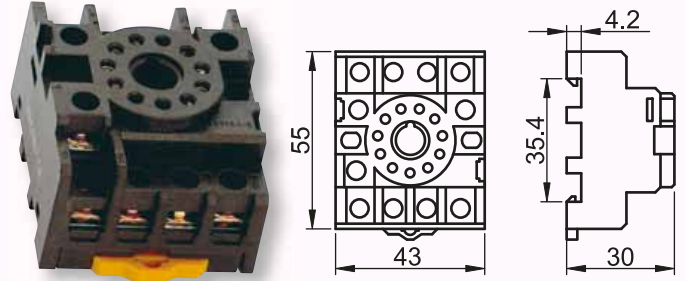

TRACON RS90.22

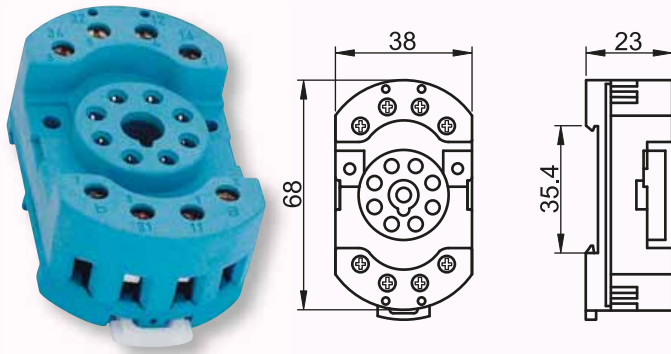

TRACON RS90.23

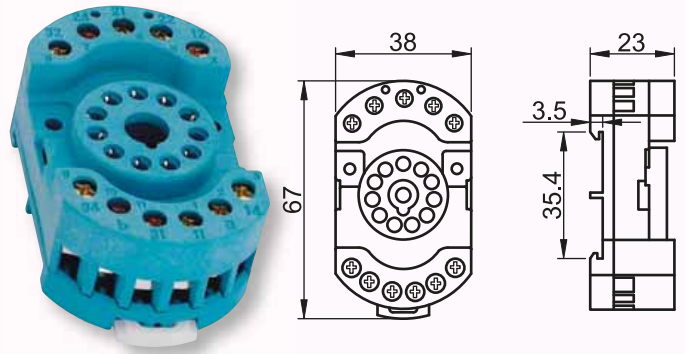

TRACON RSPSF-08AE

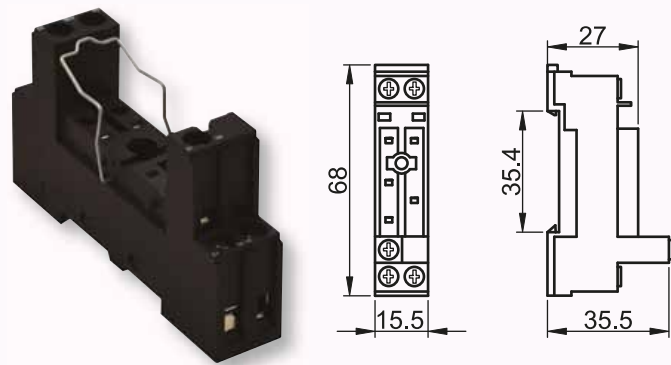

TRACON RSPSF-14AE

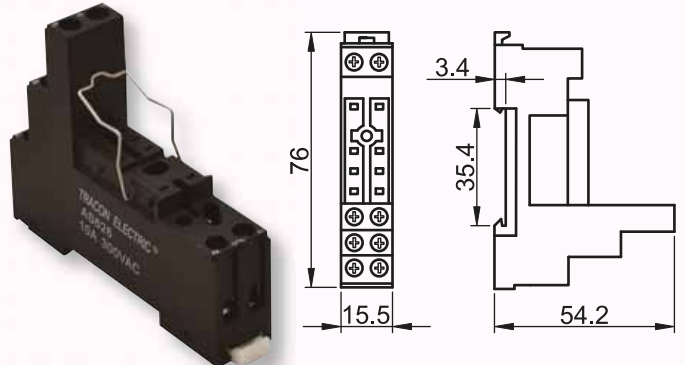

TRACON RSPYF-08A

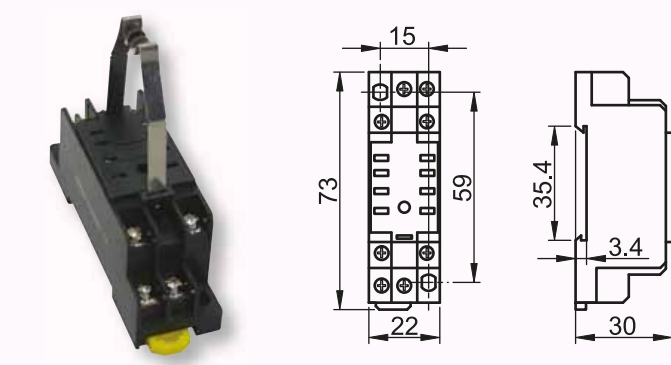

TRACON RSPYF-11A

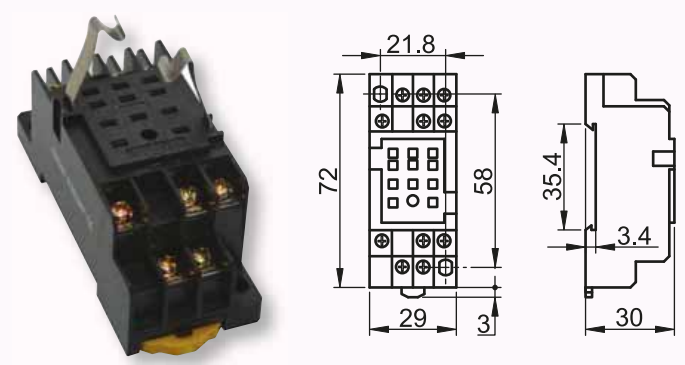

TRACON PYF14A

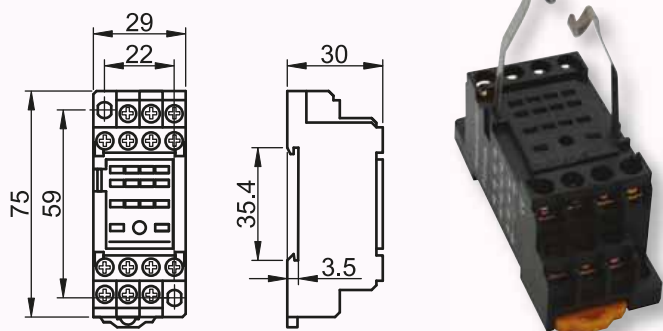

TRACON RSPTF-08A

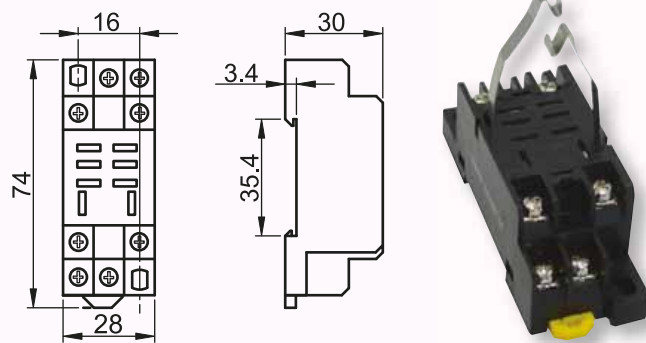

TRACON RSPTF-11A

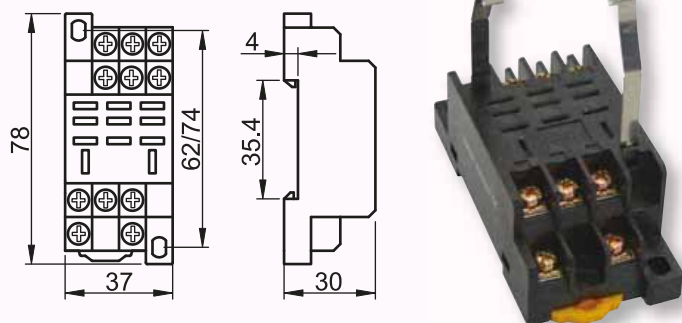

TRACON RSPTF-14A

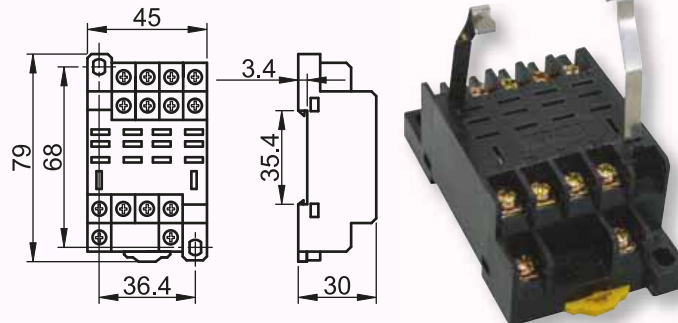

TRACON RSPMF-14

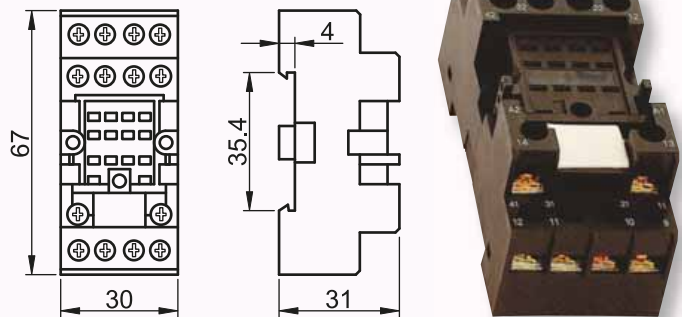

TRACON RSJQX-38FS

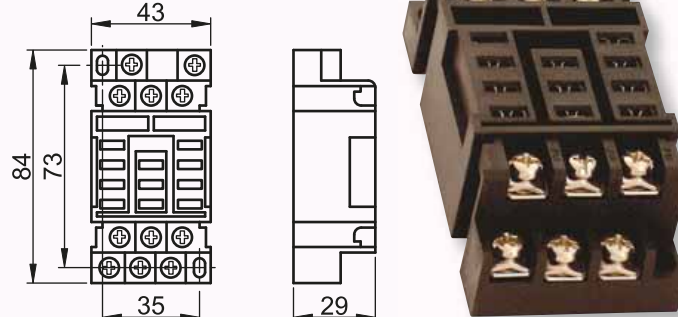

Egyenáramú tekercs működési tartomány-jelleggörbe

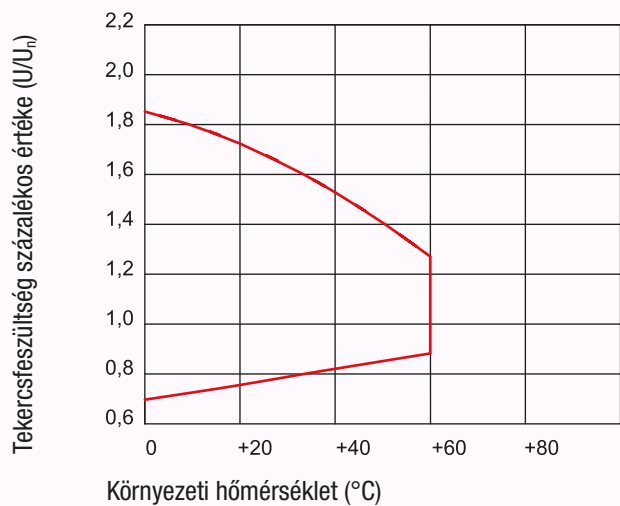

Villamos élettartam jelleggörbe

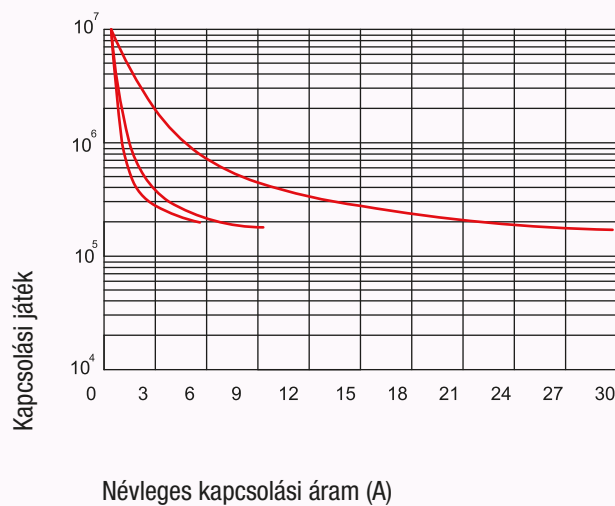

Időrelék

A moduláris időrelék vezérlőszekrénybe történő beépítésre készülnek, segítségükkel egy előre megtervezett időbeli folyamat vezérelhető. A szükséges feladat összetettségének függvényében kell meghatározni a beépítendő készüléket a környezeti és a villamos hálózat műszaki paramétereinek figyelembevételével. A csillag-delta időrelé a kalickás forgórészű villamos motorok indításánál segítkezik az előre beállított időtag szerepében.

Időzítési funkciók

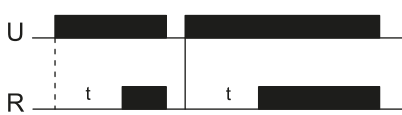

Meghúzás késleltetésű relé: a tápfeszültség (U) készülékre kapcsolásakor az időzítés „t” ideje elindul. Az időzítés leteltekor a relé (R) meghúzott állapotba kerül, és ezt az állapotát mindaddig megtartja, amíg a tápfeszültség fennáll. Amennyiben a tápfeszültség az időzítés letelte előtt megszűnik, a relé nem húz meg. A tápfeszültség visszatérével az időzítés az elejétől újraindul.



Elengedés késleltetésű relé: a tápfeszültségnek a készülékre történő kapcsolásakor a relé meghúz, és a beállított késleltetési idő elteltével elejt. Ha a feszültség a bemeneten a beállított időzítési idő letelte előtt megszűnik, a relé időkésleltetés nélkül elejt.

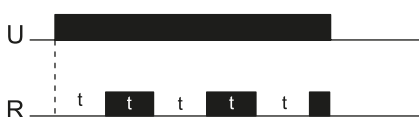

Ütemadó késleltetett meghúzással: ha a tápfeszültség (U) a készülékre van kapcsolva a relé „t” idejű időzítéssel, ciklikus ismétlődéssel ejtett, majd meghúzott állapotú. A ciklus mindig ejtett állapottal kezdődik.



Ütemadó azonnali meghúzással: ha a tápfeszültség (U) a készülékre van kapcsolva a relé „t” idejű időzítéssel, ciklikus ismétlődéssel meghúzott, majd ejtett állapotú. A ciklus mindig meghúzott állapottal kezdődik.

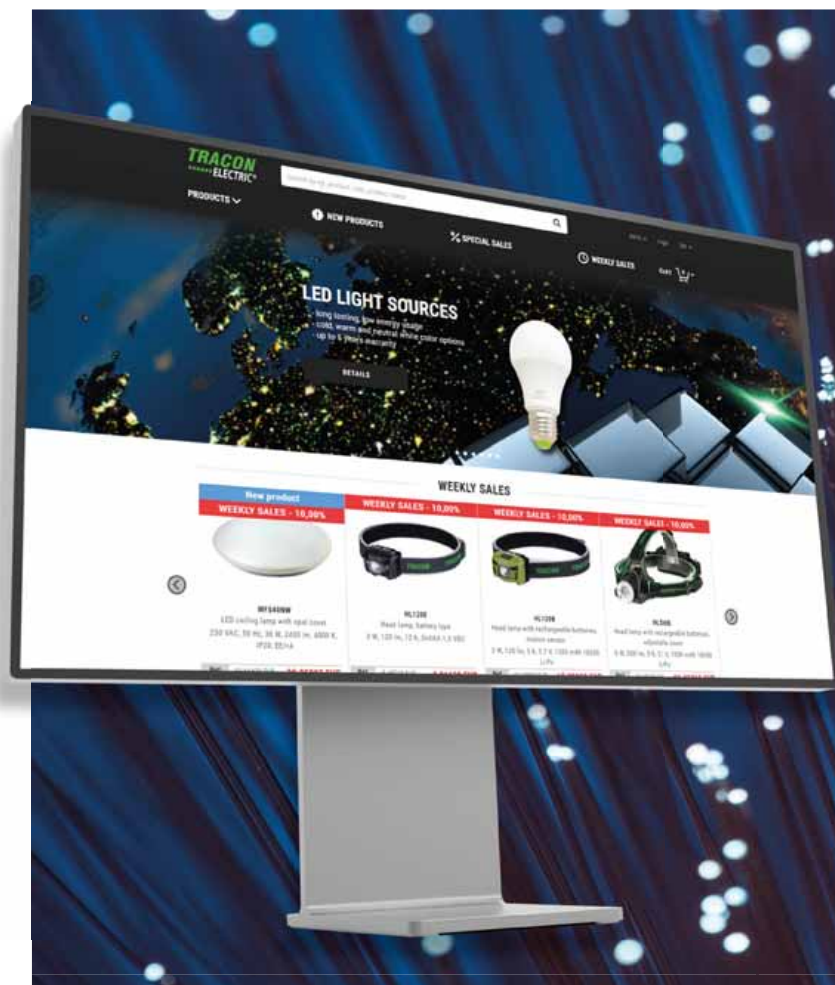

MEGÚJULT WEBÁRUHÁZUNK!

- Új, optimalizált külső
- Boltkereső
- Gyorsabb vásárlási folyamat
- Tudásbázis
- Összehasonlító modul
- Részletes termékkereső
- Mobil optimalizált megjelenítés
- Online fizetési megoldások
- 3D forgatható termékképek
- Részletes termékadatlapok

www.traconelectric.com

Egyfunkciós (meghúzáskésleltetéses) időrelé

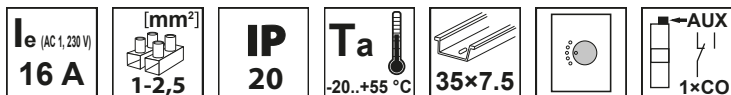

TRACON	U_m	VAC A				
NARIDON	AC/DC 12-240 V	16 A 230 VAC	± 0,2 %	± 5 %	0,1 s - 10 h	62 g

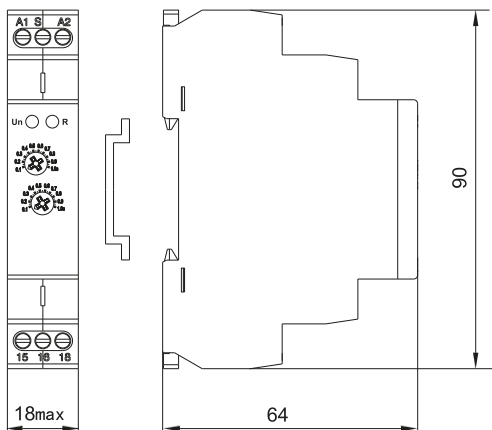

**RELEVANT STANDARD
EN 61812-1**

Alkalmazás

- Olyan alkalmazásoknál megfelelő, ahol a vezérlőjellel késleltetett bekapcsolást kívánunk megvalósítani, stb.
- Alkalmazni lehet szivattyúknál, kapcsolás utáni késleltetésű fűtés bekapcsoláskor, ventilátor kapcsolás.

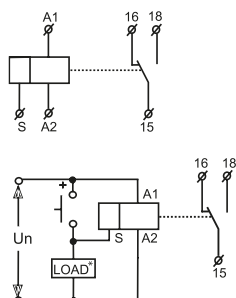

* léptető-gomb /impulzusjel/

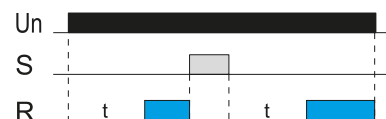

Egyfunkciós (elengedéskésleltetéses) időrelé

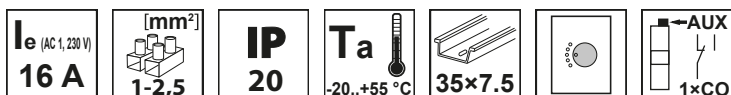

TRACON	U_m	VAC A				
NARIDOFF	AC/DC 12-240 V	16 A 230 VAC	± 0,2 %	± 5 %	0,1 s - 10 h	62 g

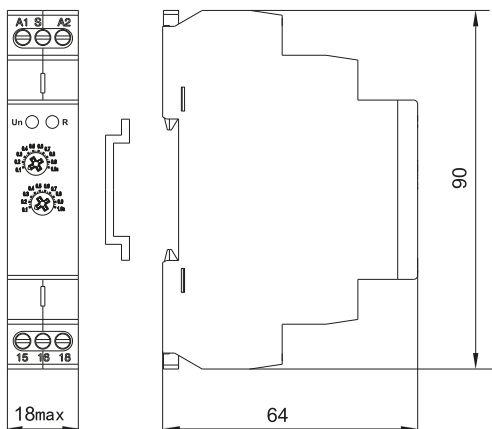

**RELEVANT STANDARD
EN 61812-1**

Alkalmazás

- Olyan alkalmazásoknál megfelelő, ahol a vezérlőjellel együtt történő bekapcsolás után késleltetésű kikapcsolást kívánunk megvalósítani.
- Alkalmazni lehet szivattyúknál, kapcsolás utáni késleltetésű fűtés kikapcsoláskor, ventilátor kapcsolás, stb.

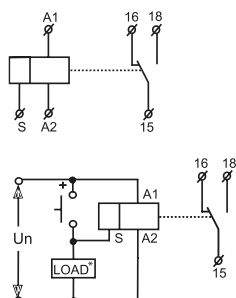

* léptető-gomb /impulzusjel/

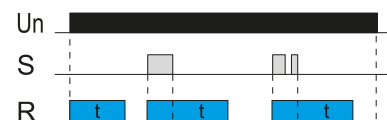

Elengedéskésleltetési tápfeszültség vezérelt időrelé

TRACON	U _m	VAC A	0 10 ha %	ha %	0 12 6 min	m
NARIDOFFS	AC/DC 12-240 V	16 A 230 VAC	± 0,2 %	± 5 %	0,1 s - 10 min.	86 g

Alkalmazás

- A készülék a tápfeszültség kiesése esetén a rá kötött fogyasztókat időkésleltetéssel átkapcsolja a tartalék áramkörre. (VÉSZ világítás, VÉSZ gázelszívás vagy távműködtetett ajtók - tűz esetén.)

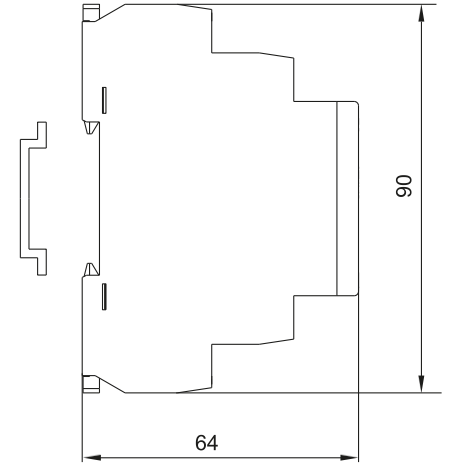
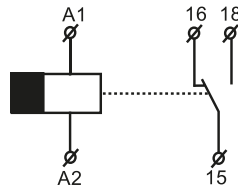

**RELEVANT STANDARD
EN 61812-1**

Csillag-delta időrelé

TRACON	U _m	VAC A	0 10 ha %	ha %	t ₁	t ₂	m
NARIST	AC/DC 12-240 V	16 A 230 VAC	± 0,2 %	± 5 %	0,1 s - 10 min.	0,1 s - 1 s	86 g

Alkalmazás

- A háromfázisú rövidrezárt forgórésű villamos motorok indításához viszonylag nagy áram szükséges. A nagy indítási áramfelvétel csökkentése érdekében a motorokat csillagkapcsolásban indítják, majd miután a motor elérte üzemi fordulatszámát, tekercseit átkapcsolják egy, a működési tapasztalatok alapján beállított időrelé segítségével delta-kapcsolásba.



**RELEVANT STANDARD
EN 61812-1**

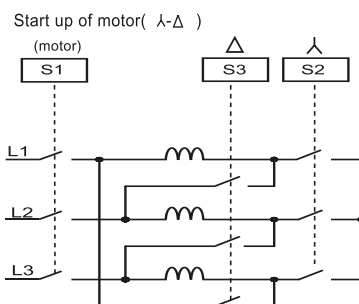
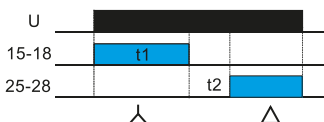
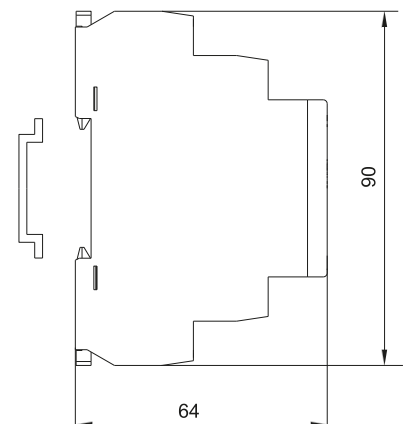
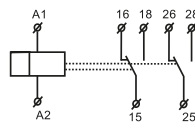

Multifunkciós időrelé (10 funkció)

I_e (AC 1, 230 V) 16 A	[mm²] 1-2,5	IP 20	T_a -20...+55 °C	35x7.5	1xCO
---	----------------------------------	------------------------	--------------------------------------	---------------	-------------

Piktogramok J/0

TRACON	U_m	VAC A	0 10 ha %	ha %	0,1 s - 10 d	64 g
NARIMF	AC/DC 12-240 V	16 A 230 VAC	± 0,2 %	± 5 %		

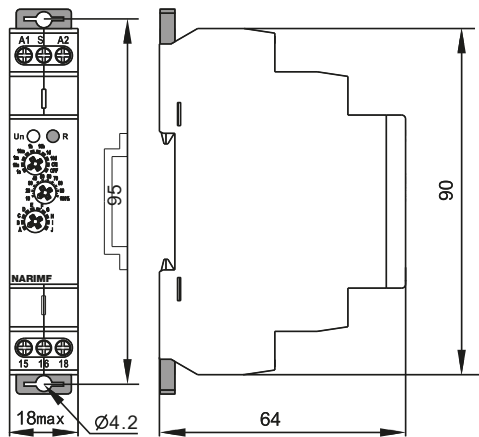

**RELEVANT STANDARD
EN 61812-1**

Alkalmazás

- A potenciométerek segítségével 10 funkciót állíthatunk be 0,1 s - 10 nap időtartományban. Az első kapcsolóval választjuk ki az időtartományt, a másodikkal az időtartomány százalékos értékét, a harmadikkal a funkciót. A relé tápfeszültséggel vagy vezérlőjellel vezéreljük.

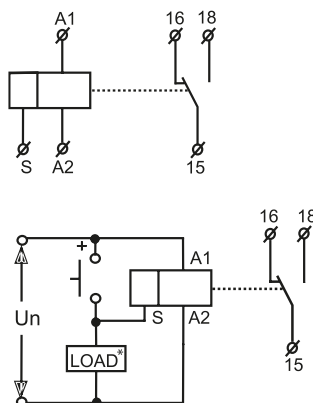

* léptető-gomb /impulzusjel/



A: Meghúzáskésleltetés



F: Elengedéskésleltetés (S vezérlőjel, 1 ütem)

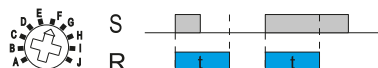

B: Elengedéskésleltetés



G: Egy ütem, vezérlő impulzus lefutó élre (BE állapotban nem indítható újra)



C: Ütemadó (Indítás KI)



H: Meghúzás- és elengedéskésleltetés



D: Ütemadó (Indítás BE)



I: Impulzusrelé



E: Elengedéskésleltetés (S vezérlőjel szünet)

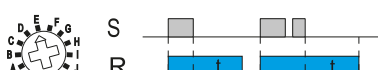

J: Impulzusgenerátor

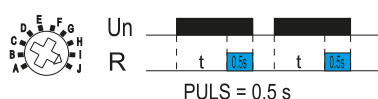

Időtartomány

0.1 - 1s	1 - 10s	6 - 60s	1 - 10min	6 - 60min	1 - 10hr	0.1 - 1day	1 - 10day	only ON	only OFF
----------	---------	---------	-----------	-----------	----------	------------	-----------	---------	----------

Lépcsőházi időkapcsoló

TRACON		P_s	I_n	L	Σ	P_{max}
NARS	0,5 sec. - 20 min.	1.5 VA	16 A (cos $\varphi = 1$)	max. 250 m	$\times 50$	max. 2.000 W max. 400 W



Alkalmazás

- Világítás késleltetett kikapcsolása folyosókon, bejáratnál, lépcsőházakban, termekben, csarnokokban vagy ventilátorok késleltetése (WC, fürdőszoba, stb.)

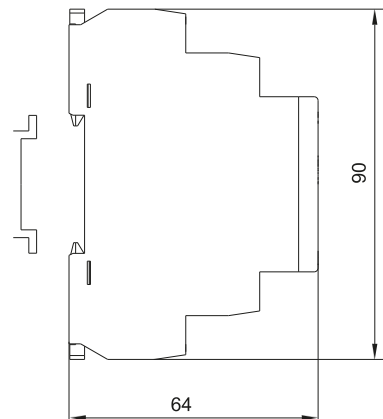
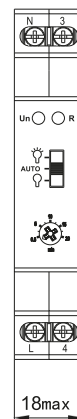
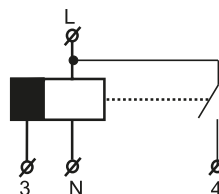

RELEVANT STANDARD
EN 61812-1

Bekötési vázlat

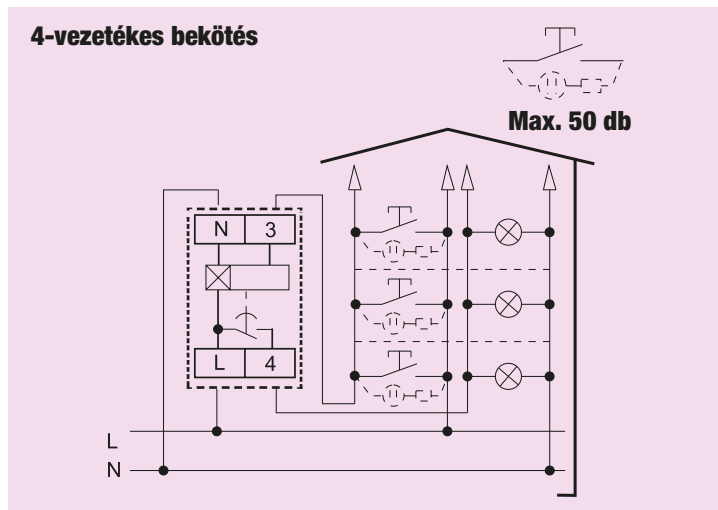
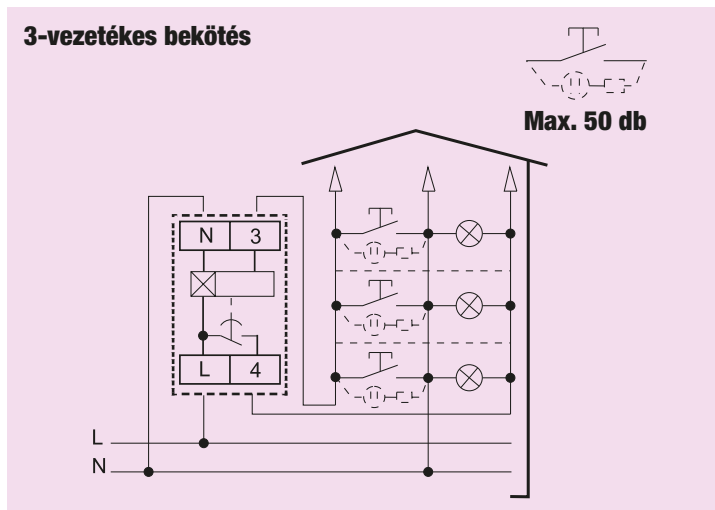

Példa

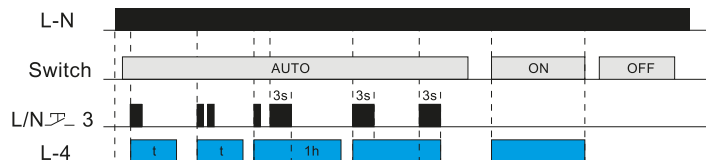
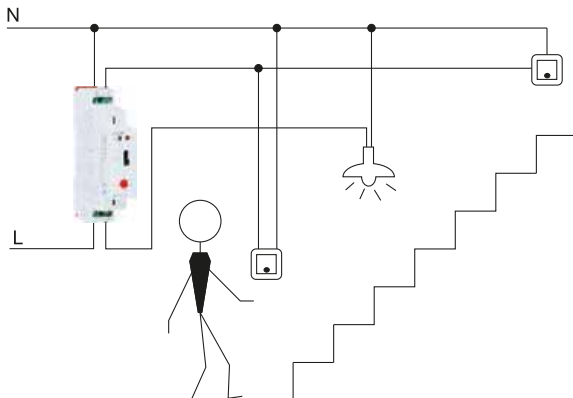

Fényforrás típusok

Hagyományos izzó	2.000 W
Halogén izzó	2.000 W
Kompakt fénycső	400 W
LED fényforrás	400 W

Feszültségfigyelő relé

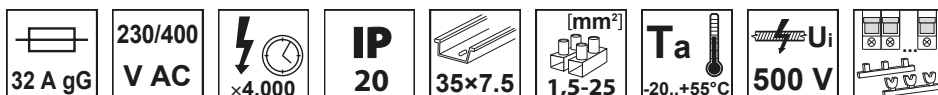

TRACON	2P	4P
	EVOU02	EVOU04
Névleges feszültség	230 V AC	230 V AC (L-N)
Névleges frekvencia	50 Hz	
Névleges áram	40 A (AC 1)	
Saját teljesítmény	AC max. 3 VA	
Felső feszültségvédelmi szint	265 V (fix)	265 V (L-N) (fix)
Felső visszakapcsolási szint	257 V (fix)	257 V (L-N) (fix)
Alsó feszültségvédelmi szint	175 V (fix)	175 V (L-N) (fix)
Alsó visszakapcsolási szint	180 V (fix)	180 V (L-N) (fix)
Kapcsolási idő	1 s	
Bekapcsolási késleltetés	2 s	
Visszakapcsolási idő	30 s	
Mérési pontatlanság	≤1%	
Tömeg	120 g	250 g

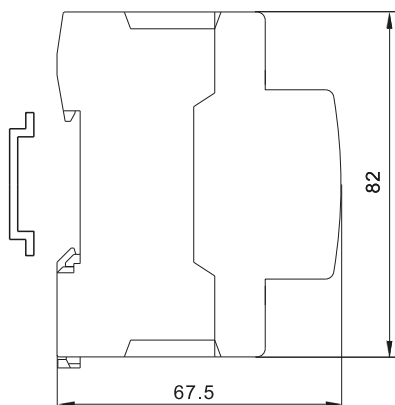
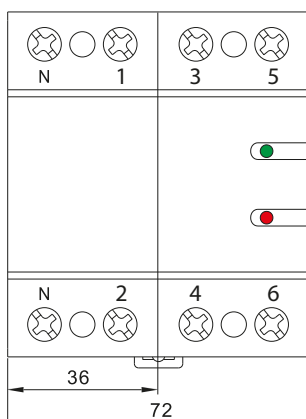

EVOU02



EVOU04

- Automatikusan visszakapcsol, amint a feszültség helyreállt!
- Feszültség növekedés és feszültség csökkenés elleni védelem háztartási berendezések számára.
- LED-es állapot visszajelzés

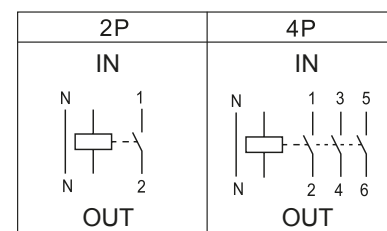
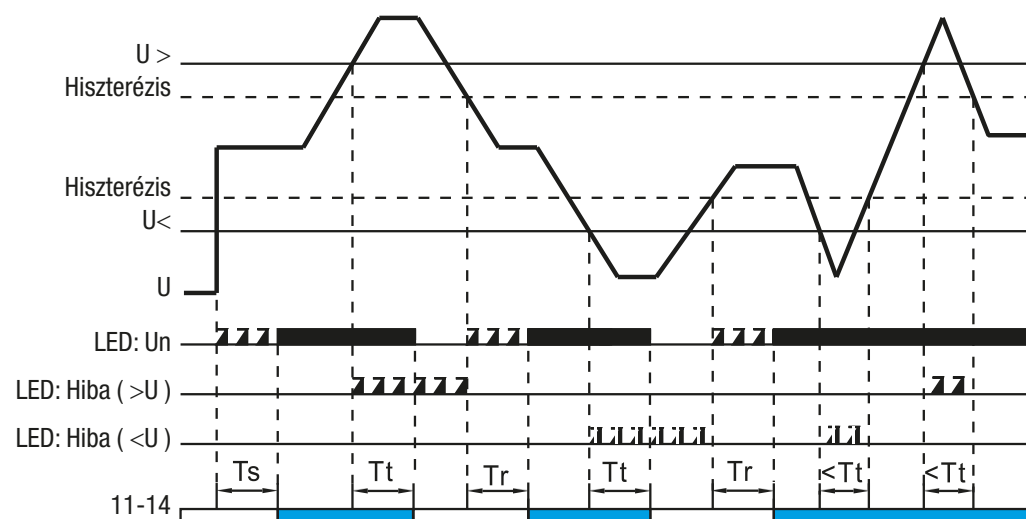

Ts: Működés felfutási idő
Tt: Kikapcsolás késleltetés
Tr: Visszaállási idő

Feszültségfigyelő relé 1 fázisra

I_e (AC 1, 230 V) 10 A	[mm²] 1-2,5	IP 20	T_a -20...+55°C	35x7.5	AUX 1xCO
---	---	------------------------	-------------------------------------	---------------	--------------------

Piktogramok **J/0**

TRACON	U_m	VDC VAC	A	U_h	U_{down}	U_{up}		
---------------	----------------------	--------------------------	----------	----------------------	-------------------------	-----------------------	--	--

NARV1 AC/DC 110-240 V 10A 230V AC / 10A 24V DC 3 % 65 V ... U_m U_m ... 260 V 0,1 s - 10 s 64 g



Alkalmazás

- Egyfázisú elektromos berendezések, villamos motorok védelmét látja el feszültség növekedés és csökkenés ellen.
- A felhasználó a megengedhető feszültségtartomány határértékeit potenciométer segítségével tudja beállítani.
- Mikor a fázis feszültség normál értékű, a relé bekapcsol.
- Ha a fázis feszültség értéke kilép a beállított tartományból, akkor a relé kikapcsol és a motor leáll.
- Mikor a hibás fázisfeszültség érték visszaáll normál állapotba, a relé bekapcsol, és a motor elindítható.

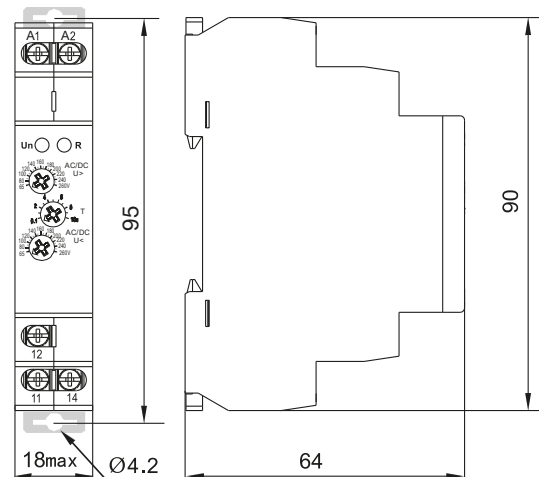

RELEVANT STANDARD
EN 60255-26

RELEVANT STANDARD
EN 60255-27



Feszültség növekedés és feszültség csökkenés működési ábra

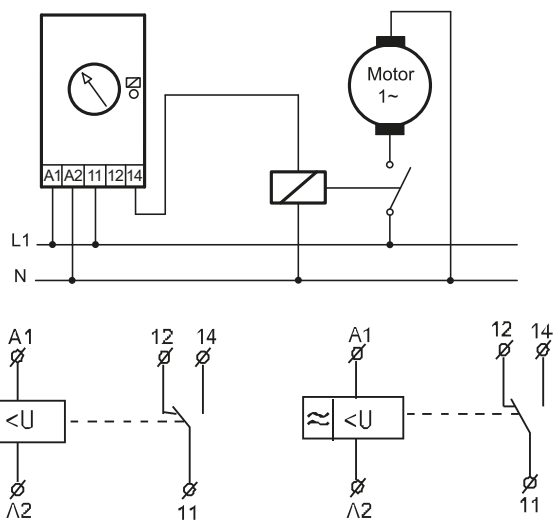
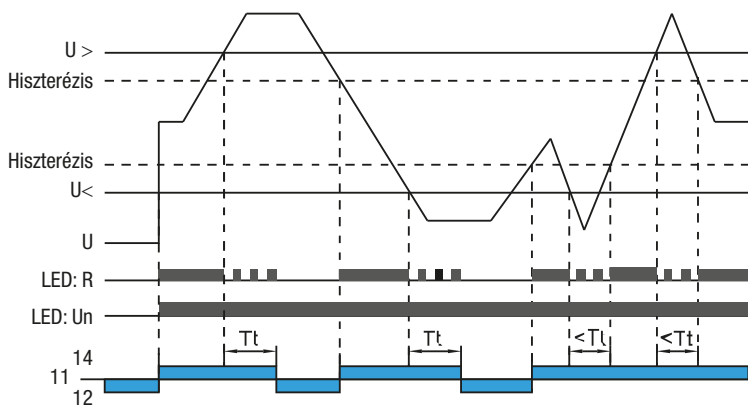

EVO MODULÁRIS TERMÉKCSALÁD



F/14-28

Feszültségfigyelő relé 3 fázisra

I_e (AC 1, 230 V)
10 A

mm^2
1-2,5

IP 20

T_a
-20...+55°C

mm
35x7.5



AUX
1xCO

L1
L2
L3

A
(L1, L2, L3)

Piktogramok J/0

TRACON

 U_m VDC
VAC**A** U_h

U_{down}

U_{up}

A
(L1, L2, L3)

0 3 6 9 12

m

NARV AC 220-460 V 10 A 230 VAC 2 % -2 ... -20 % +2 ... +20 % 8 % (fix) 0,1 s - 10 s 86 g



Alkalmazás

- Háromfázisú elektromos berendezések, villamos motorok védelmét látja el feszültség növekedés és csökkenés ellen.
- A felhasználó a megengedhető feszültségtartomány határértékeit potenciométer segítségével tudja beállítani.
- Mikor az L1, L2 és L3 fázisok feszültségei normál értékűek, a relé bekapcsol.
- Ha bármelyik fázis feszültségének értéke kilép a beállított tartományból, akkor a relé kikapcsol és a motor leáll.
- Mikor a hibás fázisfeszültség értéke visszaáll normál állapotba, a relé bekapcsol, és a motor elindítható.

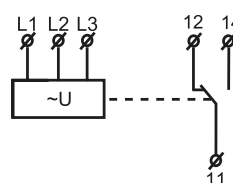
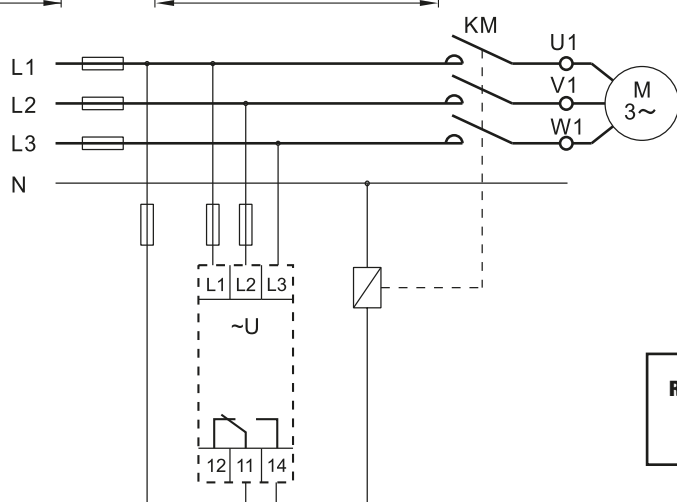

RELEVANT STANDARD
EN 60255-26

RELEVANT STANDARD
EN 60255-27

Fázis-hiba és fázis-sorrend működési ábra

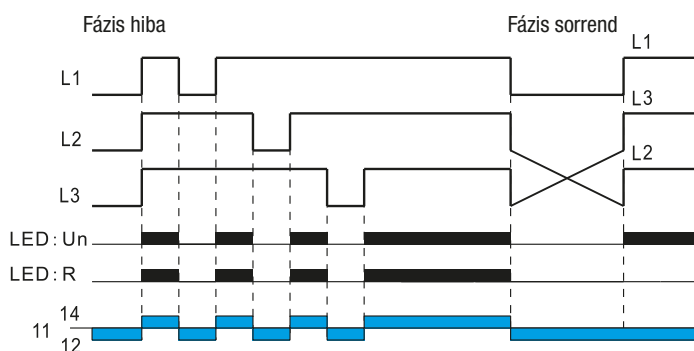

Feszültség növekedés és feszültség csökkenés működési ábra

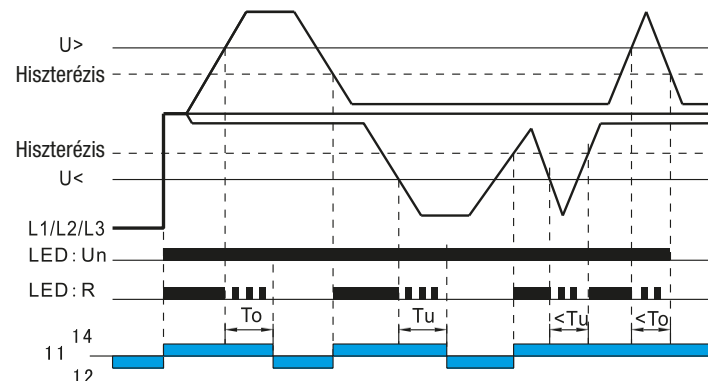

OLVASSA BE A KÓDOT!

- Nézze meg újdonságainkat
- Legyen naprakész

Kínálatunk gyorsan és folyamatosan fejlődik!
Katalógusunk a 2021. áprilisi állapotot tükrözi.
Naprakész információért látogasson el honlapunkra!

Feszültségfigyelő relé 3 fázisra, beállítható aszimmetriával és túlmelegedés elleni védelemmel



TRACON	Um	Uh	VDC VAC A	0 10 ha %	A (L1,L2,L3)	m
TFKV-04	3x230/400 V AC	max. 10 V	5 A 230 V AC	±1 %	±5 % - ±25 % (L1-L2)	85 g

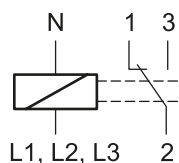

RELEVANT STANDARD
EN 60255-26, -27

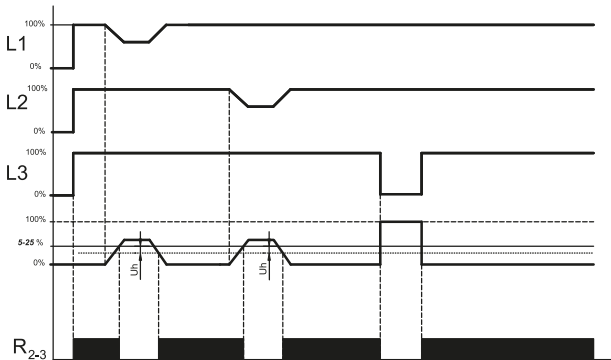
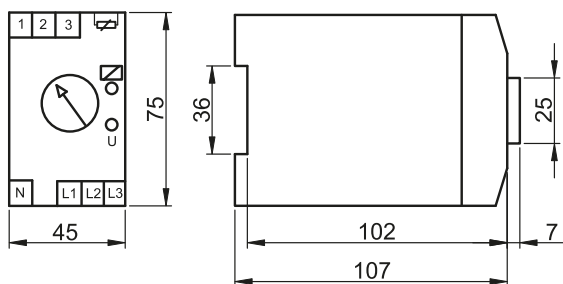

Háromfázisú motorok túlfeszültség, valamint túlmelegedés elleni védelmére fejlesztették ki. A felhasználó a megengedhető túlfeszültség határértékét be tudja állítani a potenciométer segítségével. Mikor az L1, L2 és L3 fázisok feszültségei normál értékűek, a relé bekapcsol. Ha bármelyik fázis feszültség értéke meghaladja a beállított határfeszültség értékét, akkor a relé kikapcsol, és a motor leáll. Mikor a hibás fázis feszültségének értéke visszaáll normál állapotba, a relé bekapcsol és a motor elindítható. Ha a motor el van látva PTC jelleggörbéjű termisztorral, akkor a készülék alkalmas a motor tekerceselésének túlmelegedés elleni védelmére is. A piktogrammal jelölt csatlakozókapcsokba bekötött termisztor ellenállása a motor hőmérséklet-emelkedésekor megváltozik, és ekkor a relé kikapcsolja a kontaktort, a motor leáll. Amennyiben a motor hőmérséklete visszaáll normál üzemi értékre, akkor a relé bekapcsol és a motor ismét elindítható.

Megjegyzés: Ha a túlmelegedés elleni funkciót nem használjuk, akkor a relénél a termisztor csatlakozókapcsait rövidre kell zárni!

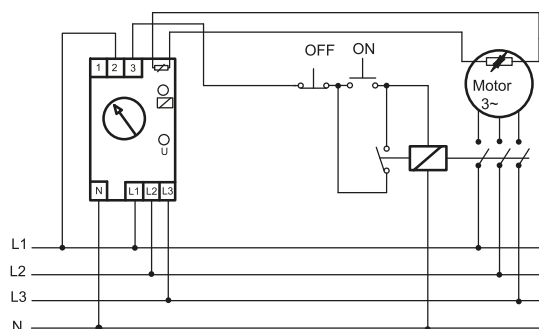

PTC termisztor túlmelegedés elleni védelemmel ellátott feszültségfigyelő relékhez

Ha a védendő motor nincs ellátva PTC jelleggörbéjű termisztorral, akkor a TFKV-04 típusú feszültségfigyelő reléhez külső PTC jelleggörbéjű termisztor is csatlakoztatható. A motor tekerceselésének hőmérsékletemelkedésekor a motor felületén elhelyezett ezen termisztor hőmérséklete is emelkedik.

A termisztor a relé piktogrammal jelölt csatlakozókapcsaiba kell csatlakoztatni a fenti bekötési ábra szerint.



Feszültségfigyelő relé 3 fázisra, nullavezető nélküli hálózatokban

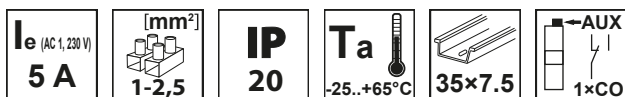

TRACON	U_m	VDC VAC	A	0 10 ha %	U_{down}	U_{up}	m
TFKV-02	3×400 V AC	5 A 230 V AC	±1 %	0,7 U_n (fix)	1,2 U_n (fix)	285 g	

Háromfázisú, nullavezető nélküli rendszerekben alkalmazott háromfázisú motorok védelmére fejlesztették ki. Mikor az L1 – L2 – L3 fázisok feszültsége normál értékű, akkor a relé bekapcsol és a motor elindítható. Ha bármelyik fázis feszültsége a megengedett érték alá csökken vagy megszakad, akkor a relé kikapcsol és a motor leáll. Amennyiben a hibás fázis feszültsége visszaáll normál értékre, akkor a relé bekapcsol és a motor újra elindítható.

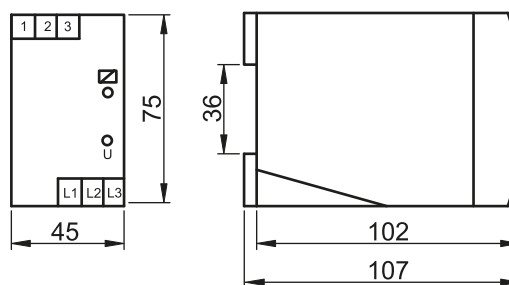
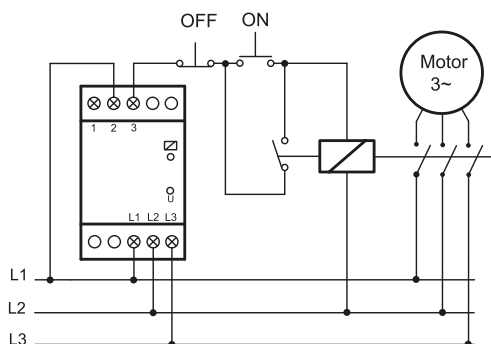
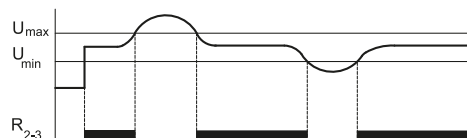
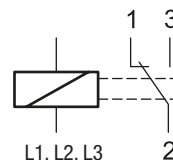



iOS / Android





- Webáruház és katalógus
- Termék gyorskereső
- Állandó és napi akciók
- Boltkereső térképpel
- Vonalkód és QR kód olvasó
- Naprakész információk







Kompakt feszültségfigyelő relé beállítható időkésleltetéssel

TRACON	U_m		U_h	VDC VAC	A	U_{down}	U_{up}		
	1~	3~							
TFKV-09	3×1×230 V AC	3×230/400 V AC	max. 20 V	5 A 230 V AC		160 V AC (fix)	260 V AC (fix)	5 min. – 15 min.	85 g
TFKV-10	3×1×230 V AC	3×230/400 V AC		10 A 24 V AC/DC		160 V AC (fix)	260 V AC (fix)	0 s – 10 s	85 g

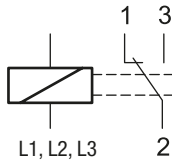

**RELEVANT STANDARD
EN 60255-26**

**RELEVANT STANDARD
EN 60255-27**

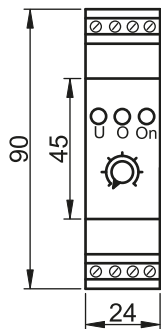
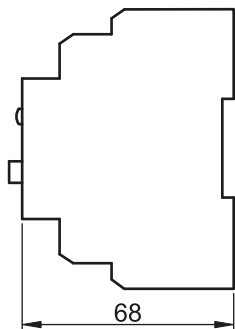

Mikroprocesszor alapú készülékek, melyek feszültségcsökkenéssel, valamint feszültségnövekedéssel szemben nyújtanak védelmet. Az eszközöket háromfázisú rendszerekben való üzemeltetésre tervezték, de működnek egyfázisú rendszerben is. A védelmi relé minden egyes fázisban érzékeli a feszültséget, és lekapcsolja a relét, ha szükséges. A készülék folyamatosan ellenőrzi a feszültség szinteket normál működés közben. Ha bármelyik fázis feszültsége 160 V alá esik a nulla vezetőhöz képest, akkor a készülék azonnal lekapcsolja a relét a rendszer védelme érdekében. Ha mindegyik feszültség szint ismét 180 V fölé kerül, akkor a készülék 0-15 perc késleltetés (beállítható időkésleltetés) után ismét bekapcsolja a relét és a motor újra elindítható. Ha a feszültség szint bármelyik fázisban 260 V fölé növekszik, akkor a relé szintén kikapcsolja a rendszert. Amikor a szintek ismét megfelelőek, akkor az eszköz 0-15 perc késleltetés után (előlapon elhelyezett potenciométer segítségével beállítható időkésleltetés) visszakapcsolja a rendszert. A készülék egyfázisú rendszerben is alkalmazható. Ebben az esetben a fázist rá kell csatlakoztatni mindegyik bemenetre, hogy a rendszer ellenőrizve legyen.

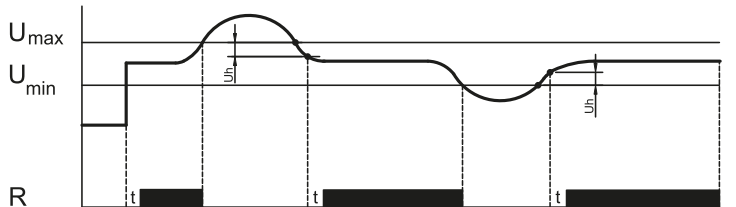

1-fázisú rendszerben való használat esetén

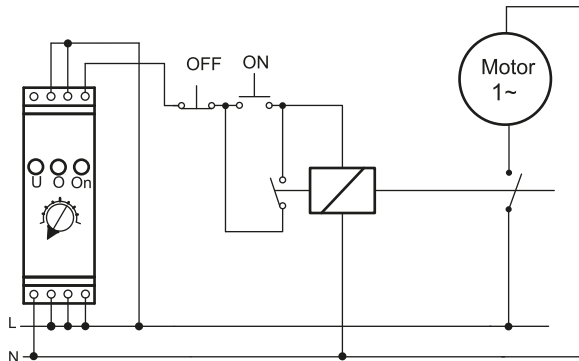

3-fázisú rendszerben való használat esetén

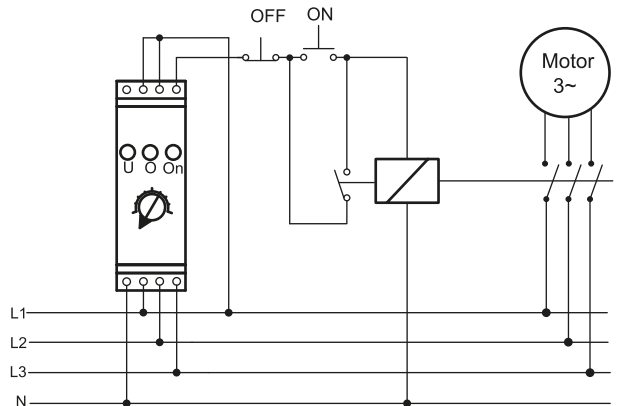

OLVASSA BE A KÓDOT!

- Nézze meg újdonságainkat
- Legyen naprakész

**Kínálatunk gyorsan és folyamatosan fejlődik!
Katalógusunk a 2021. áprilisi állapotot tükrözi.**

**Naprakész információért
látogasson el honlapunkra!**

Áramcsökkenés és áramnövekedés elleni védelmi relék

I_e (AC 1, 230 V) **5 A** | $[mm^2]$ **1-2,5** | **IP 20** | T_a $-25..+65^\circ C$ | **35x7.5** | **1xCO**

Piktogramok J/O

TRACON	U_m	VDC VAC A	I_{down}	I_{up}	t_1	t_2	m
TFKV-AKA05	230 V AC	5 A 230 V AC	–	0,5 – 5 A	0,5 – 8 s	0,5 – 15 s	280 g
TFKV-AKD05	230 V AC	5 A 230 V AC	0,5 – 5 A	–	0,5 – 8 s	0,5 – 15 s	

Ezeket a védőreléket motorok vagy valamilyen hálózat védelmére fejlesztették ki áramcsökkenés vagy áramnövekedés ellen. A készüléket elsősorban 100 A fölötti névleges áramú fogyasztók védelmének való alkalmazásra ajánljuk. A készülékek rendelkeznek két beállítható idő-késleltetéssel (indítási és relékimenet), valamint beállítható áramvédelmi szinttel. A készülék a mért áramot összehasonlítja a beállított áramvédelmi szinttel. Ha a mért áram normál szinten van, akkor a relé érintkezői nem fognak állapotot váltani.

A készülékhez 5A szekunder áramú áramváltót kell alkalmazni. Ha a mért áramérték a beállított értéktől eltérő nagyságú, akkor a relé kimenete a beállított késleltetési idő végén állapotot fog váltani. Amennyiben az áram értéke a beállított késleltetési időn belül visszaáll a beállított áramvédelmi szintre, akkor a relé gerjesztetlen állapotban marad.

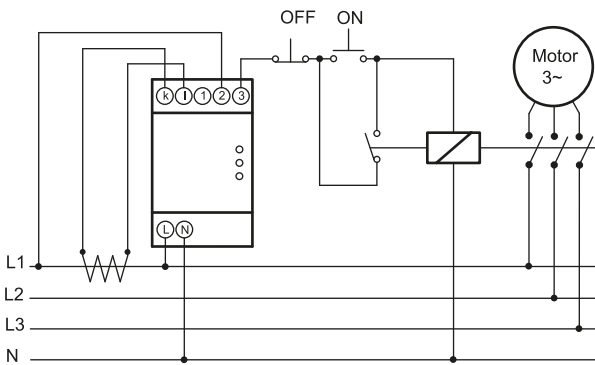
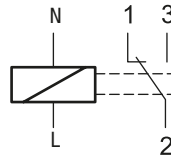

Működési diagramm - TFKV-AKA05

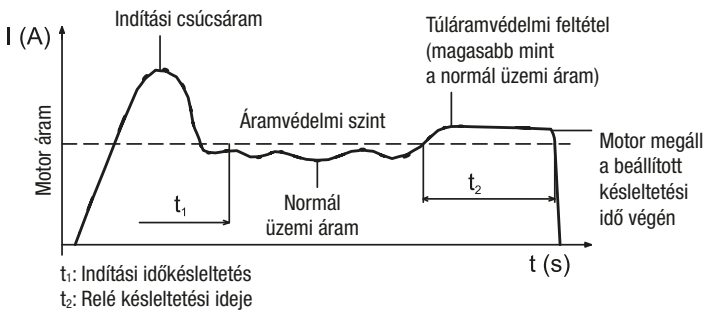

RELEVANT STANDARD
EN 60255-26

RELEVANT STANDARD
EN 60255-27

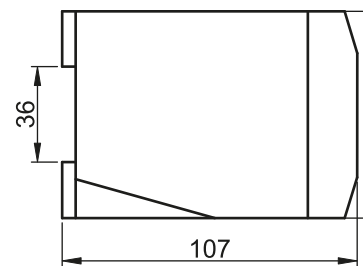
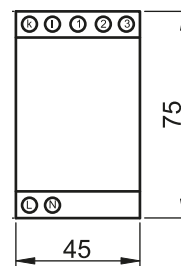

Működési diagramm - TFKV-AKD05

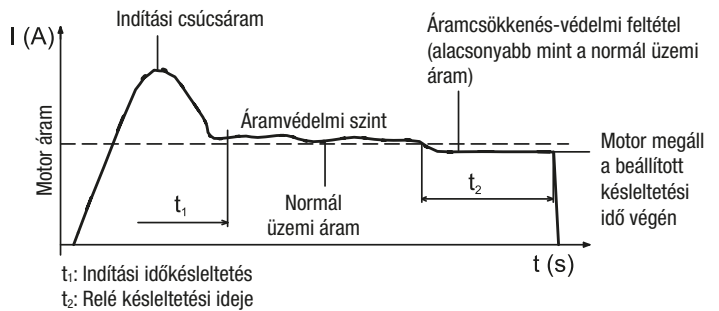



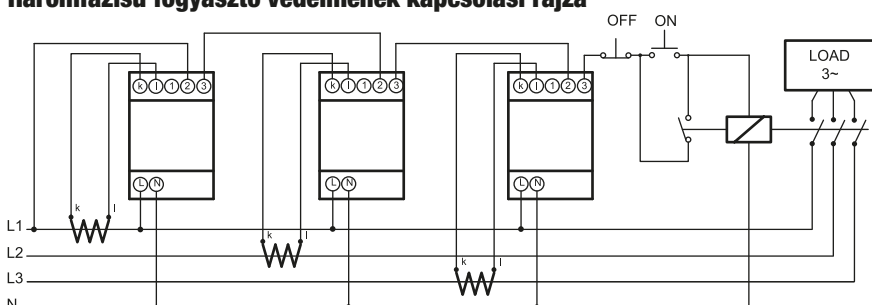



















Háromfázisú fogyasztó védelmének kapcsolási rajza



Táblázat fejlécek piktogramjai

 Névleges működtető feszültség	 Névleges teljesítmény	 Névleges teljesítmény	 Megjegyzés, kiegészítés
 Primer feszültség	 Szekunder feszültség	 Szekunder áram	 Szekunder teljesítmény
 Kétállású	 Háromállású	 Kulcskivételi pozíció (bal)	 Kulcskivételi pozíció (bal vagy jobb)
 Kulcskivételi pozíció (középső)	 Kulcskivételi pozíció	 Reteszoldás: elfordítással	 Reteszoldás: kulccsal
 Érintkezők villamos adatai	 Világító egység	 Méret	 Foglalat típusa
 Meghúzási nyomaték	 Menet	 Rátolható csatlakozó	 Tömítőszelence
 Alap kivétel	 Tokozva IP 44	 IP.. Védettségi fokozat	 Szín
 Tömeg	 Hangjelző	 Védettségi fokozat frontoldalról	

Műszaki adatok piktogramjai

 Névleges feszültség (V)	 Névleges működtető feszültség	 Névleges szigetelési feszültség	 Névleges lökőfeszültség-állóság
 Névleges üzemi áram	 Névleges frekvencia	 Javasolt előtétbiztosító	 Beköthető vezeték
 A működtetőfej 90°-onként elforgatható!	 A működtetőfej és a kar 90°-onként elforgatható!	 Bekapcsolási erő	 Kikapcsolási erő
 Mechanikus élettartam	 Hőállósági osztály	 I. érintésvédelmi osztály	 Kapcsolási gyakoriság
 Védettség beépítve (homlokoldal felől)	 Kapcsok védettsége (alap)	 Védettségi fokozat	 Rezgésállóság
 Relatív páratartalom	 Környezeti hőmérséklet	 Kivágási méret	

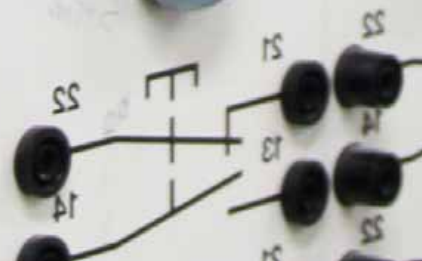
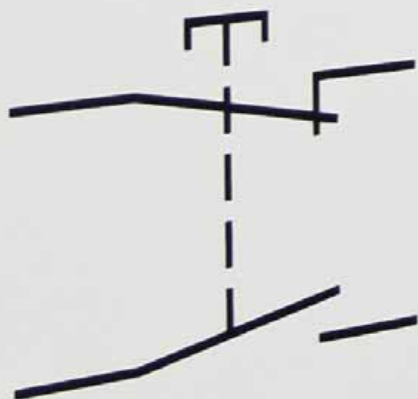

				
LS15 helyzetkapcsolók 2	LS7 helyzetkapcsolók 5	LSME helyzetkapcsolók 8	VP helyzetkapcsolók 12	VT helyzetkapcsolók 16
				
VM helyzetkapcsolók 20	KW helyzetkapcsolók (mikrokapcsolók) 24	Egyszerű nyomógombok 26	Kiálló nyomógomb 26	Világító nyomógomb 27
				
Jelölt nyomógomb 28	Gombafejű nyomógomb 29	Kettős, be-ki nyomógomb 30	Karos kapcsoló 30	Világítókaros kapcsoló 31
				
Kulcsos kapcsoló 31	Érintkező egység NYG(K)3 sorozathoz 32	Tokozat 32	Kiegészítők 34	Feszültség-, árammérők, hangjelzők 35
				
Fényjelző oszlopok 35	LED-es jelzőlámpák 36	Egyszerű nyomógombok 37	Jelölt nyomógombok 38	Kulcsos gombafejű nyomógombok 39
				
Kettős, be-ki nyomógombok 40	Karos kapcsolók 42	Kulcsos kapcsolók 43	Jelzőizzók 44	Érintkezőelemek 44
				
Tokozatok 45	Relés biztonsági kapcsolók 46	TES készülékapcsolók 48	TVTR Egyfázisú elválasztó transzformátorok 52	TVTRB Egyfázisú szigetelő transzformátorok 54

LS15 helyzetkapcsolók

I_{th} 15 A	I_e (AC 1, 230 V) 5 A	I_e (AC 15, 230 V) 2 A	I_e (DC 13, 250 V) 0,3 A	U_i 500 V	[mm²] 0,5-1,5	ON-OFF-ON... sc/h ×1.800	T_a -25...+55°C	IP 00
-------------------------------	---	--	--	-------------------------------	------------------------------------	---------------------------------------	-------------------------------------	-----------------

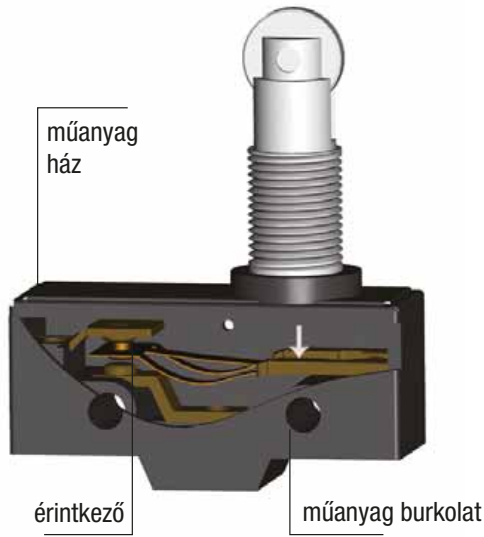

Érintkező típusa: C

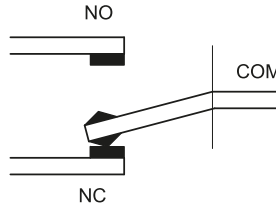

RELEVANT STANDARD
EN 60947-1

RELEVANT STANDARD
EN 60947-5-1

- erős ház
- váltó érintkező
- szemes sarus kötési pont
- könnyű vezetékbekeötés
- többféle kapcsolómechanizmussal

Rugózáras kivitel

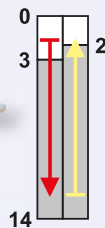

Működési út (mm)

TRACON LS15GM-B

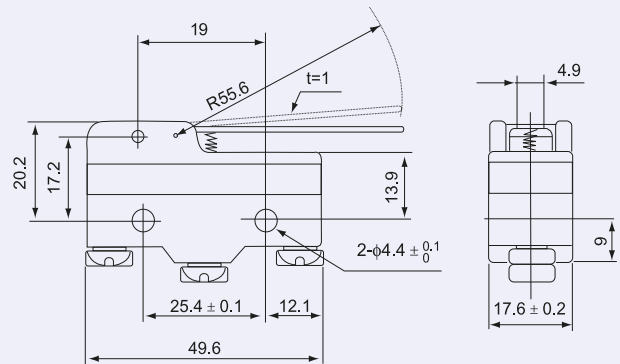

Rugózáras kivitel

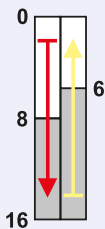

Működési út (mm)

TRACON LS15GW-B

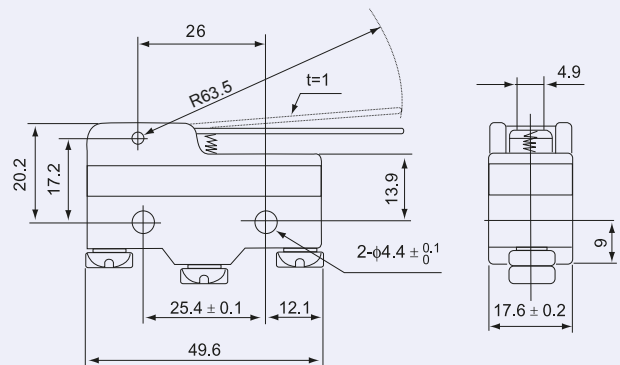

Rugózáras kivitel

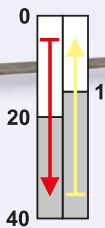

Működési út (mm)

TRACON LS15HW24-B

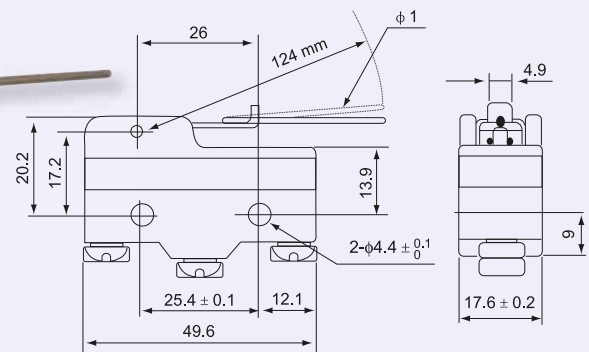

Rugózáras kivitel

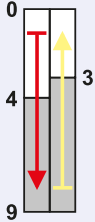

Működési út (mm)

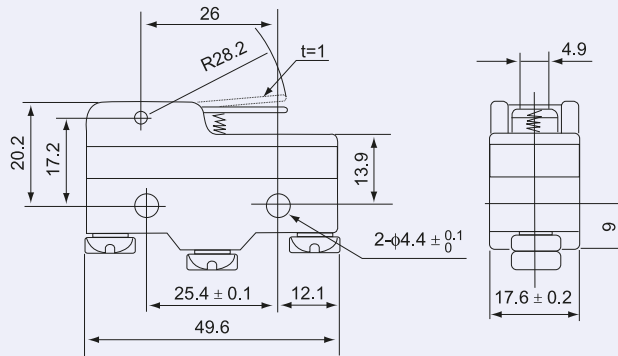

TRACON LS15GW21-B

Rugózáras, görgős kivitel

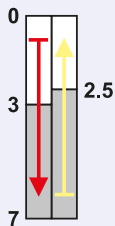

Működési út (mm)

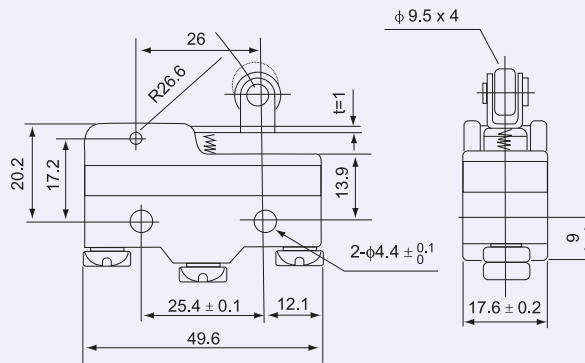

TRACON LS15GW22-B

Rugózáras, görgős kivitel

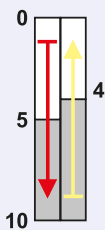

Működési út (mm)

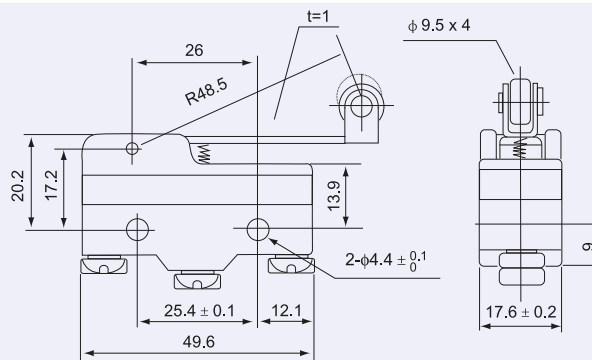

TRACON LS15GW2-B

Görgős kivitel

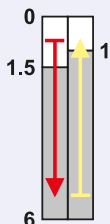

Működési út (mm)

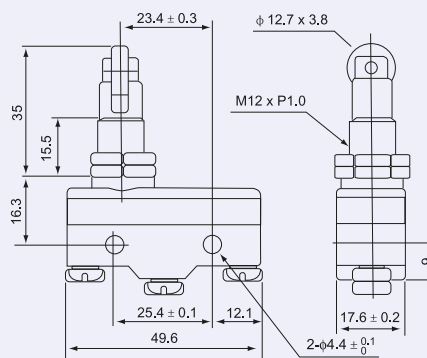

TRACON LS15GQ21-B



Görgős kivitel

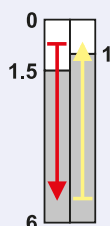

Működési út (mm)

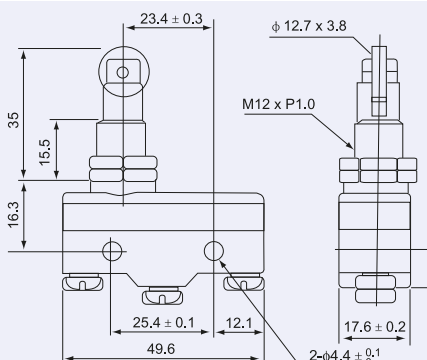

TRACON LS15GQ22-B



Kúpos ütközős kivitel

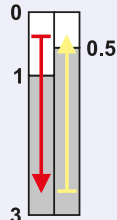

Működési út (mm)

TRACON LS15GD-B

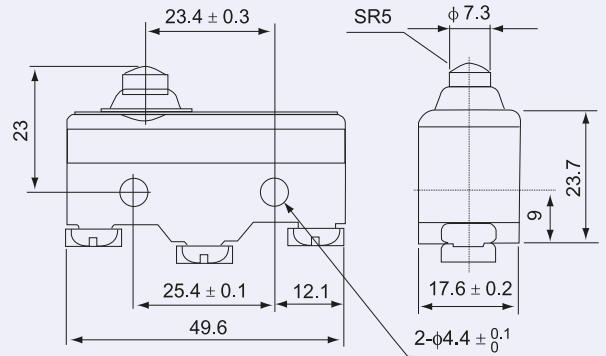

Kúpos ütközős kivitel

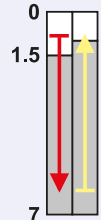

Működési út (mm)

TRACON LS15GQ-B

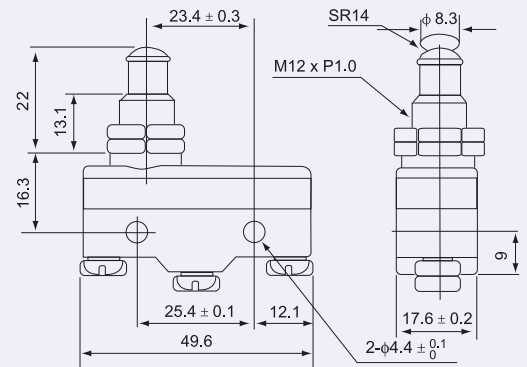

Ütközős kivitel

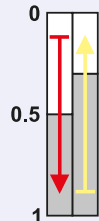

Működési út (mm)

TRACON LS15G-B

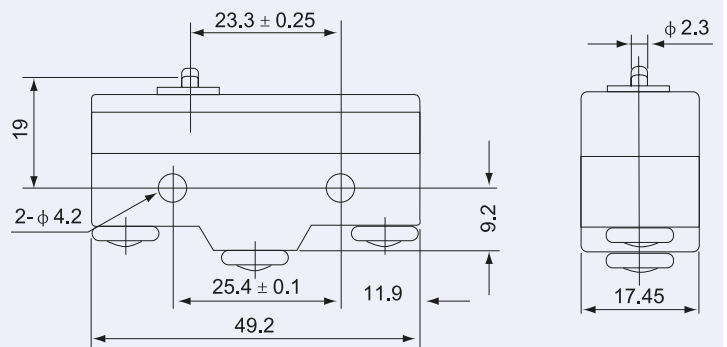

Műanyag burkolat



IP 40



TRACON LS15-COV



Ipari relék



J/2-J/9

LS7 helyzetkapcsolók

I_{th} 10 A	I_e (AC 1, 230 V) 5 A	I_e (AC 15, 230 V) 2 A	I_e (DC 13, 250 V) 0,3 A	U_i 500 V	[mm ²] 0,5-1,5	$\times 10^6$	ON-OFF-ON... sc/h $\times 1.800$	T_a -25...+55°C	IP 40	Piktogramok	K/0
-------------------------------	---	--	--	-------------------------------	-------------------------------	---------------	--	-------------------------------------	-----------------	--------------------	------------

RELEVANT STANDARD
EN 60947-1

RELEVANT STANDARD
EN 60947-5-1



Érintkező típusa: C

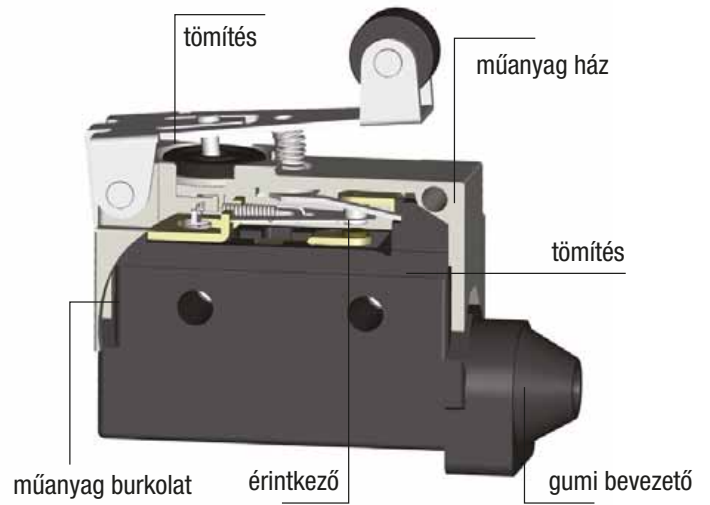
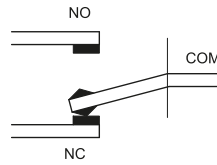

- erős ház
- váltó érintkező
- szemes sarus kötési pont
- könnyű vezeték bekötés
- többféle kapcsolómechanizmussal

Rugózáras kivitel

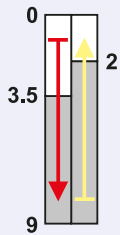

Működési út (mm)

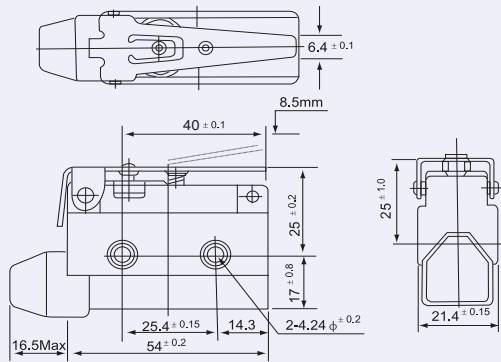

TRACON LS7140

Rugózáras kivitel

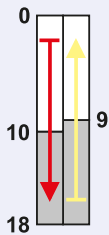

Működési út (mm)

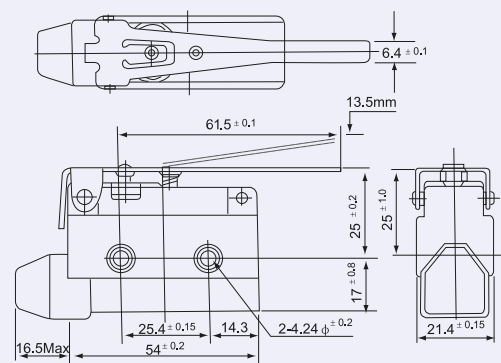

TRACON LS7120

Rugózáras, görgős kivitel

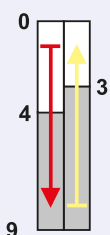

Működési út (mm)

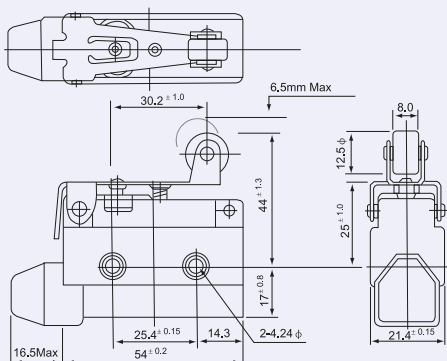

TRACON LS7141

Rugózáras, görgős kivitel

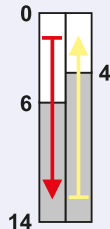

Működési út (mm)

TRACON LS7121

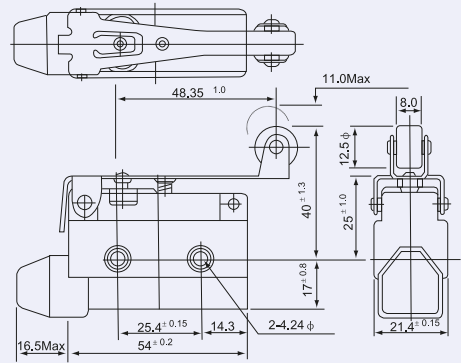

Rugózáras, csuklógörgős kivitel

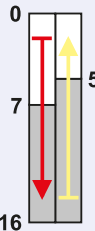

Működési út (mm)

TRACON LS7144

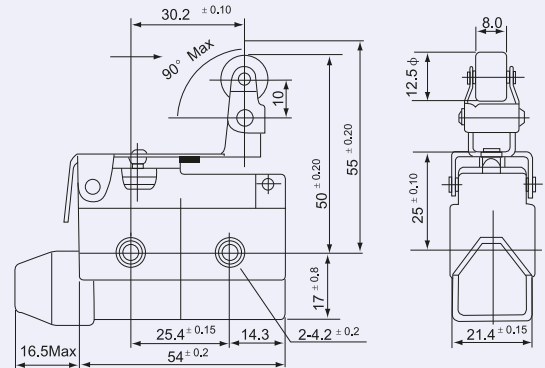

Rugózáras, csuklógörgős kivitel

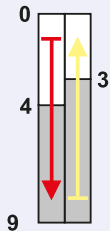

Működési út (mm)

TRACON LS7124

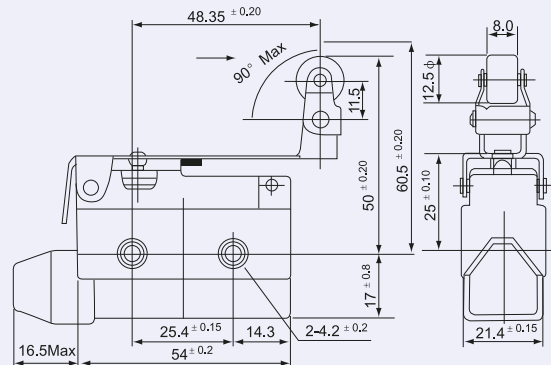

Kúpos ütközős kivitel



Működési út (mm)

TRACON LS7100

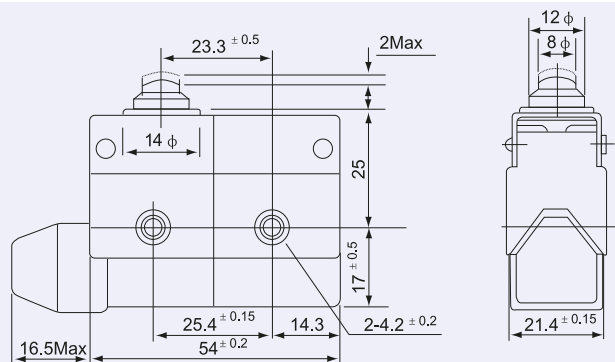

Kúpos ütközős kivitel

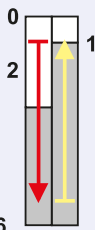

Működési út (mm)

TRACON LS7110

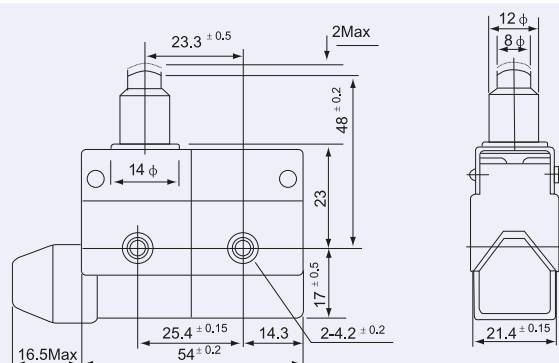

Kúpos ütközős kivitel

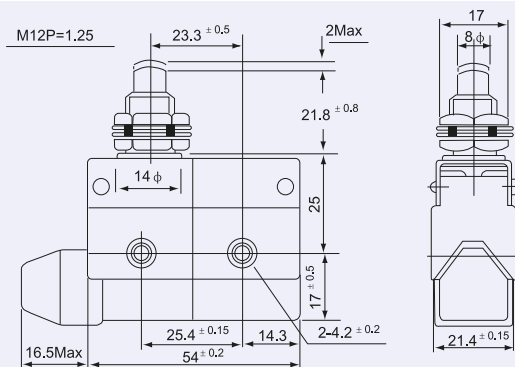
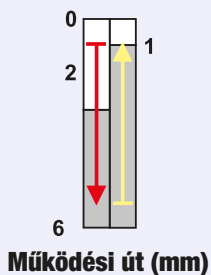

TRACON LS7310

Göngös kivitel

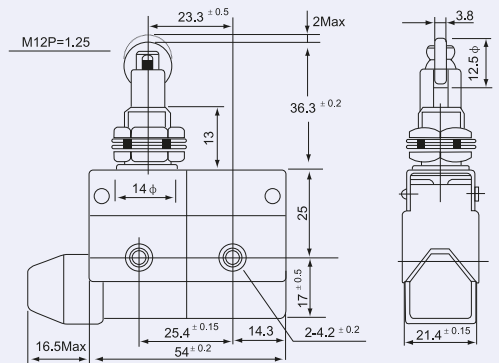
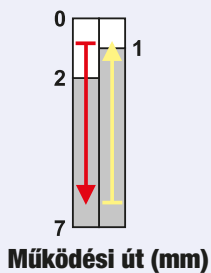

TRACON LS7311

Göngös kivitel

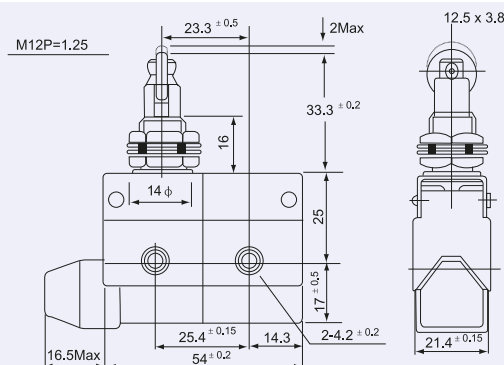
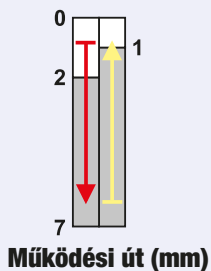

TRACON LS7312

Rugós, pálcás kivitel

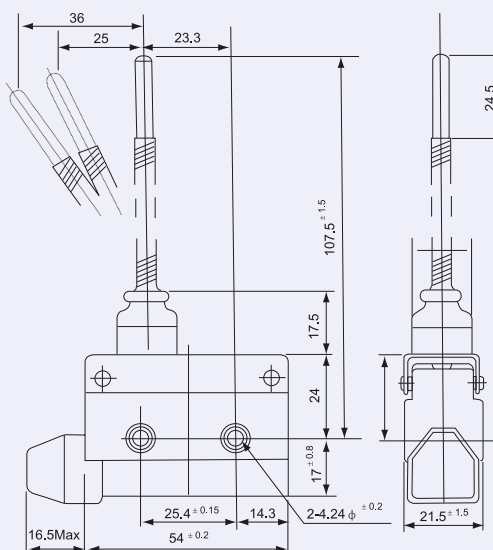

TRACON LS7166

LSME helyzetkapcsolók

I_{th} 10 A	I_e (AC 1, 230 V) 5 A	I_e (AC 15, 230 V) 2 A	I_e (DC 13, 230 V) 0,3 A	U_i 500 V	[mm²] 0,5-1,5	x10⁶ x1.800	ON-OFF-ON... sc/h	T_a -25...+55°C	IP 65
-------------------------------	---	--	--	-------------------------------	------------------------------------	----------------------------------	-----------------------------	-------------------------------------	-----------------

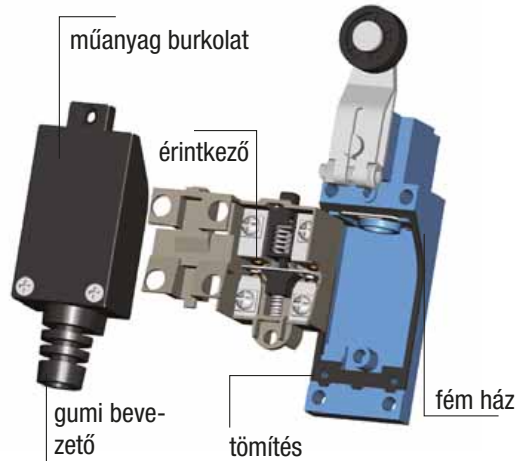

Érintkező típusa: Za

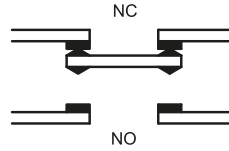

RELEVANT STANDARD
EN 60947-1

RELEVANT STANDARD
EN 60947-5-1

- Dupla érintkezők
- Masszív szerkezet
- Műanyag és alumínium öntvény
- Vízálló és olajálló

- Dupla rugós mechanizmus
- Hosszú élettartam
- Könnyen vezetékezhető

Rugós, pálcás kivitel

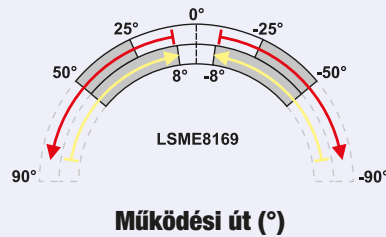

TRACON LSME8169

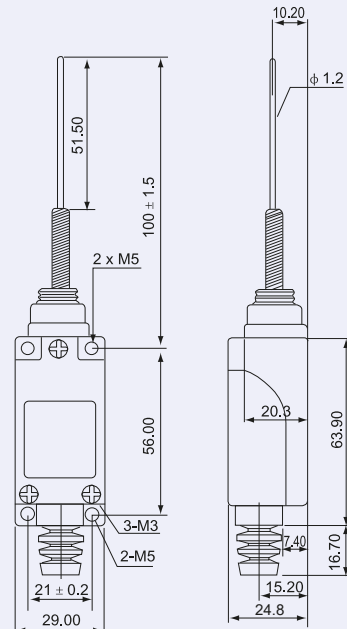

Rugós, pálcás kivitel



TRACON LSME9101

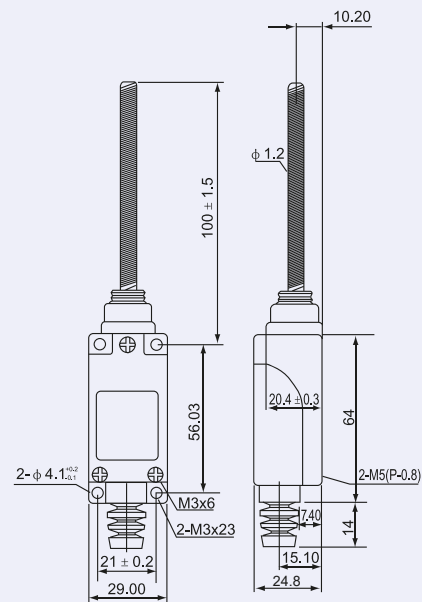

Rugós, pálcás kivitel

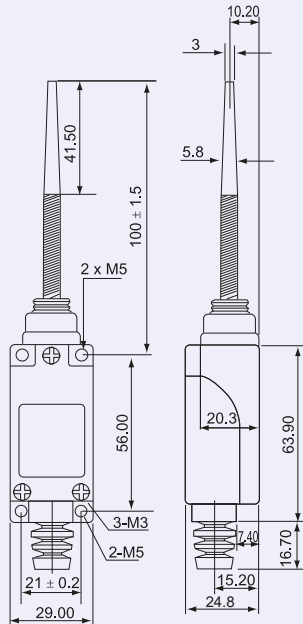
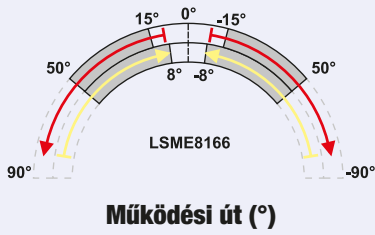

TRACON LSME8166

Kúpos ütközős kivitel

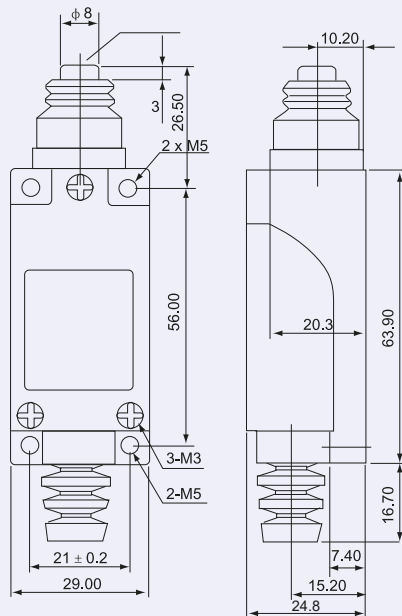
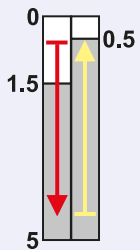

TRACON LSME8111

Görgős kivitel

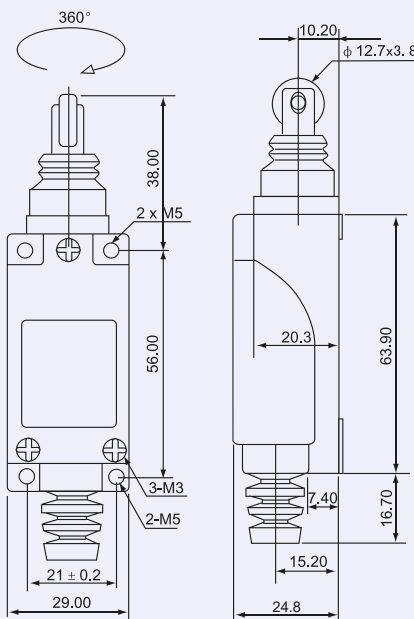
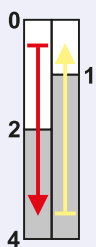

TRACON LSME8122

Billenőkaros, pálcás kivitel

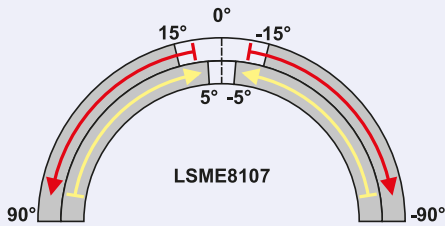

Működési út (°)

TRACON LSME8107

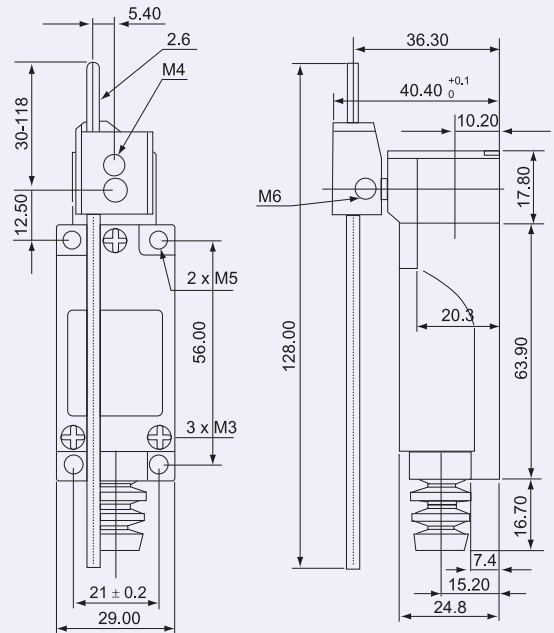

Görgős ütközős kivitel

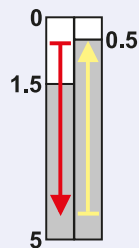

Működési út (mm)

TRACON LSME8112

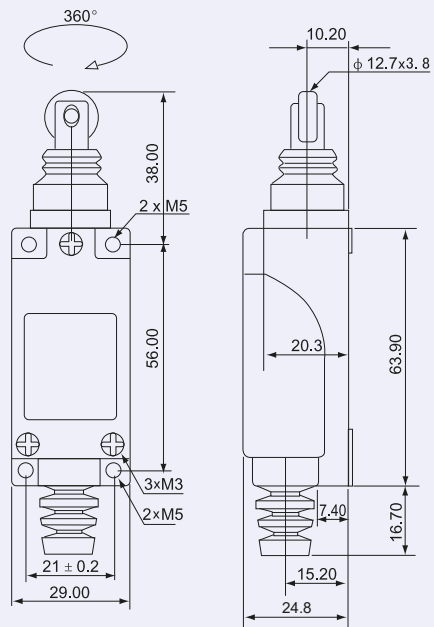

Lengőkaros kivitel

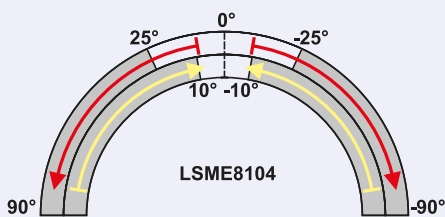

Működési út (°)

TRACON LSME8104

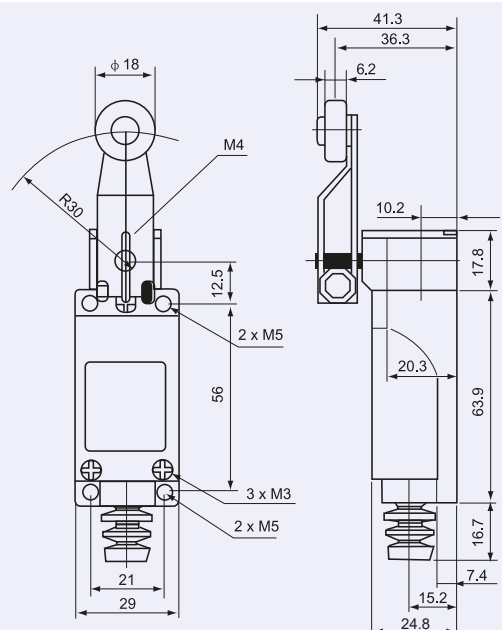

Állítható görgős-karos kivitel

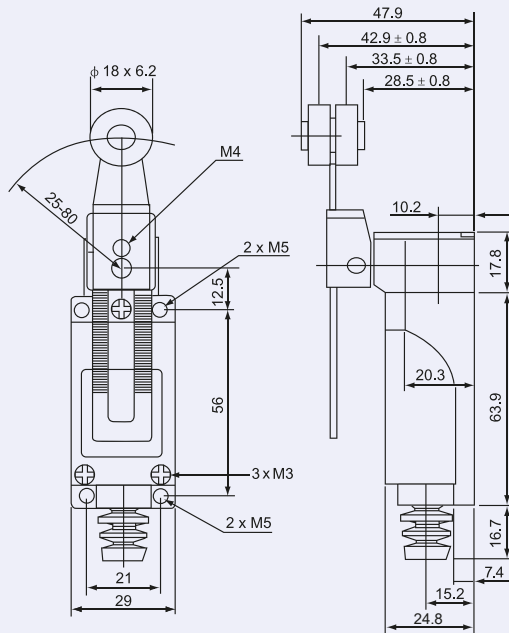
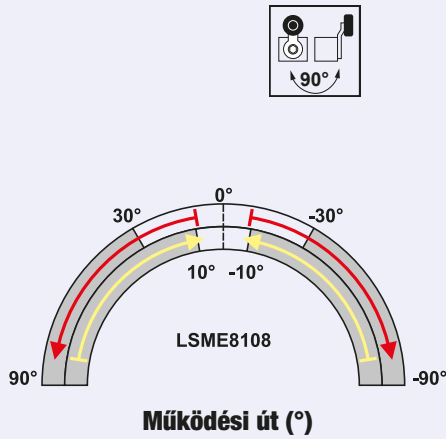

TRACON LSME8108

RELÉK

TRACON
ELECTRIC®

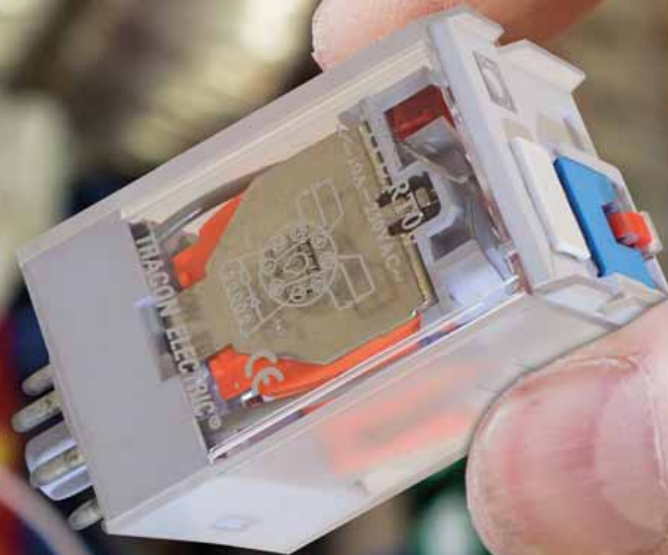

J/2-J/9



OLVASSA BE A KÓDOT!

- Nézze meg újdonságainkat
- Legyen naprakész

Kínálatunk gyorsan és folyamatosan fejlődik!
Katalógusunk a 2021. áprilisi állapotot tükrözi.
Naprakész információért
látogasson el honlapunkra!

VP helyzetkapcsolók

I_{th} 10 A	I_e (AC 1, 230 V) 5 A	I_e (AC 15, 230 V) 2 A	I_e (DC 13, 250 V) 0,3 A	U_i 500 V	[mm²] 0,75-1,5	5×10⁶	ON-OFF-ON... sc/h ×1.800	T_a -25...+55°C	IP 65
-------------------------------	---	--	--	-------------------------------	-------------------------------------	-------------------------	--------------------------------	-------------------------------------	-----------------

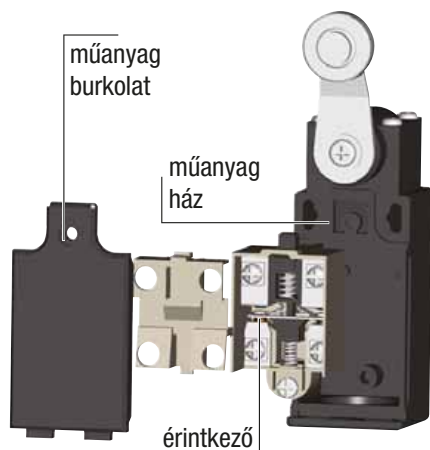

Érintkező típusa: **Za**

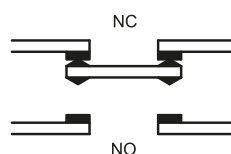

- Dupla érintkezők
- Erős műanyag burkolat
- Masszív szerkezet
- Precíz kapcsolás
- Hosszú élettartam
- Könnyen vezetékezhető

RELEVANT STANDARD
EN 60947-5-1

RELEVANT STANDARD
EN 60947-1

Lengőkaros, görgős kivitel

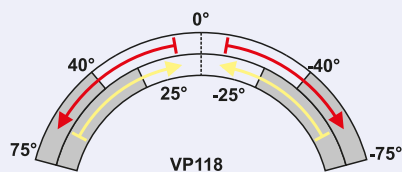
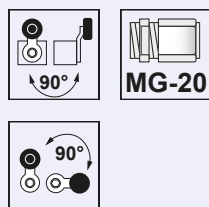

Működési út (°)

TRACON VP118

d = 18 mm
fém görgő

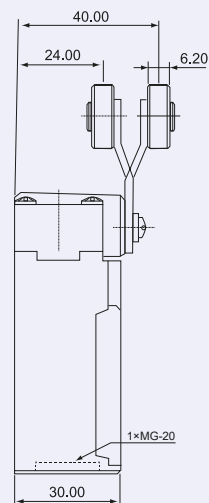
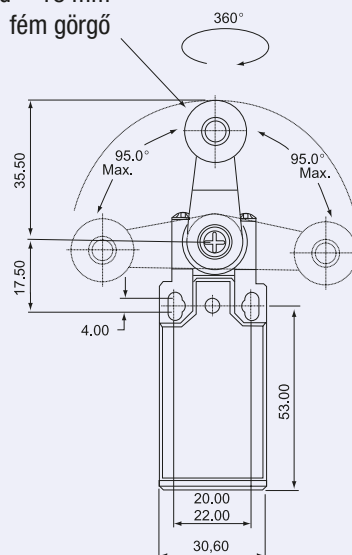

Lengőkaros kivitel

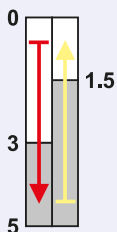
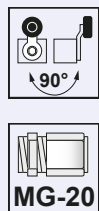

Működési út (mm)

TRACON VP121

d = 12,7 mm
fém görgő

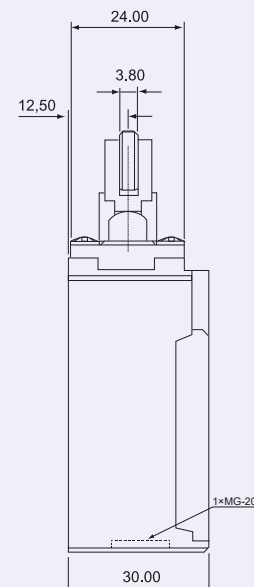
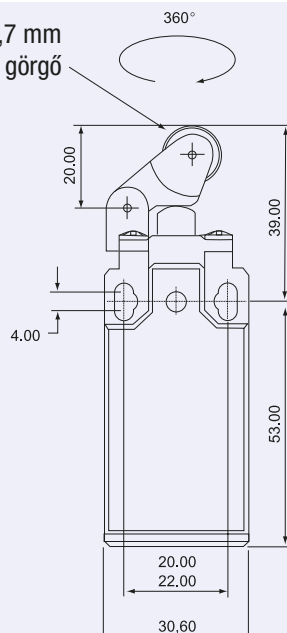

Állítható görgőkaros kivitel

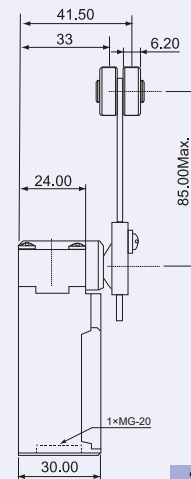
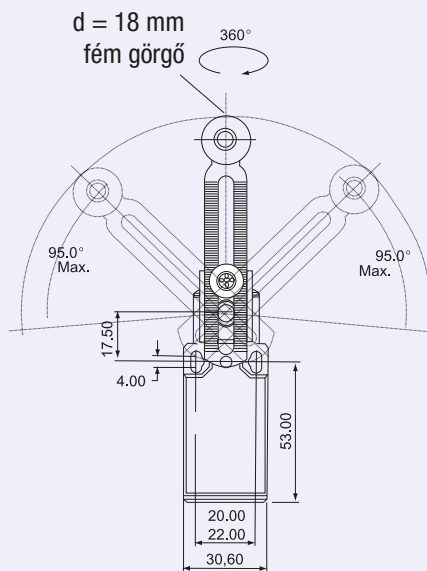
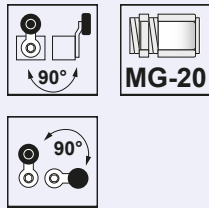

TRACON VP145

Működtetés irányok

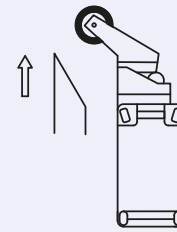
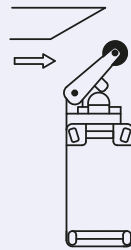
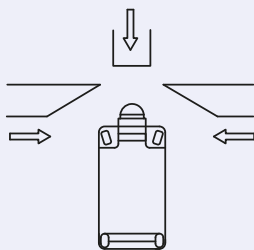

TGE
ELOSZTÓSZEKRÉNYEK

TRACON
ELECTRIC®



H/14

Rugós, pálcás kivitel

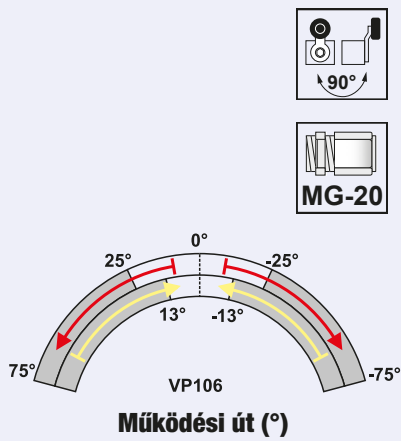

TRACON VP106

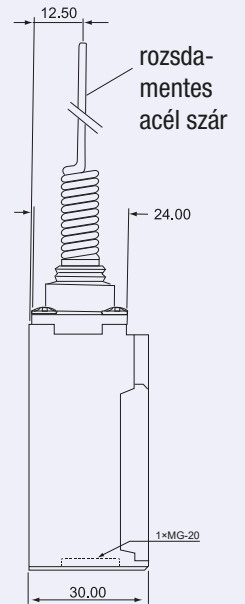
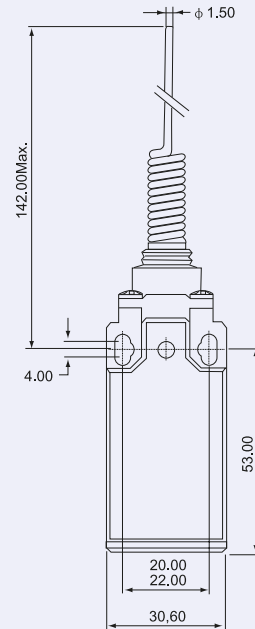

Görgös ütközős kivitel

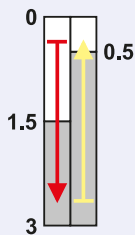

Működési út (mm)

TRACON VP102

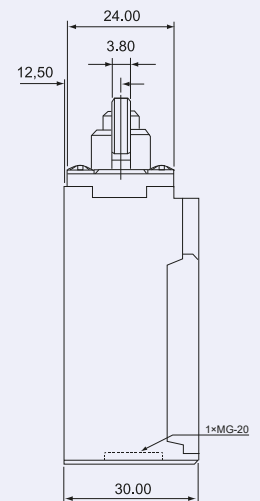
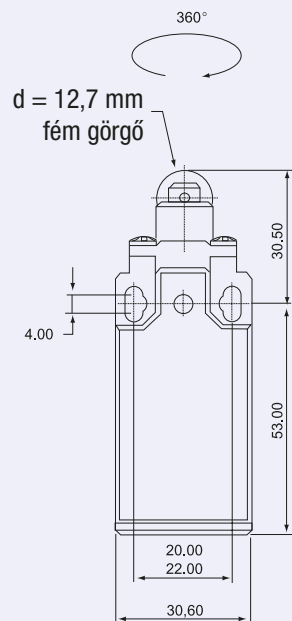

Görgös ütközős kivitel

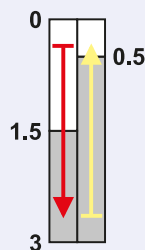
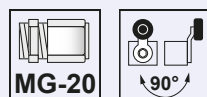

Működési út (mm)

TRACON VP110

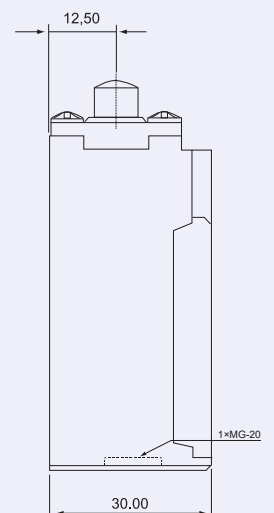
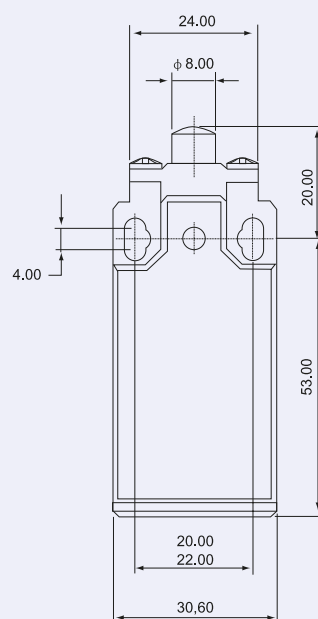

Rugószáras (műanyag+acél) kivitel

műanyag pálc

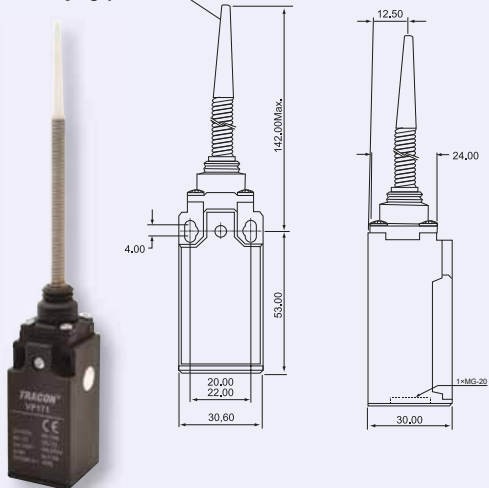

TRACON VP171

Helyzetkapcsoló, rugószáras (acél)

rozsdamentes acél szár

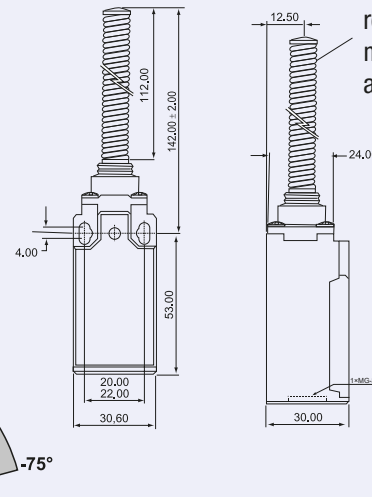

TRACON VP181



Gumigörgős kivitel

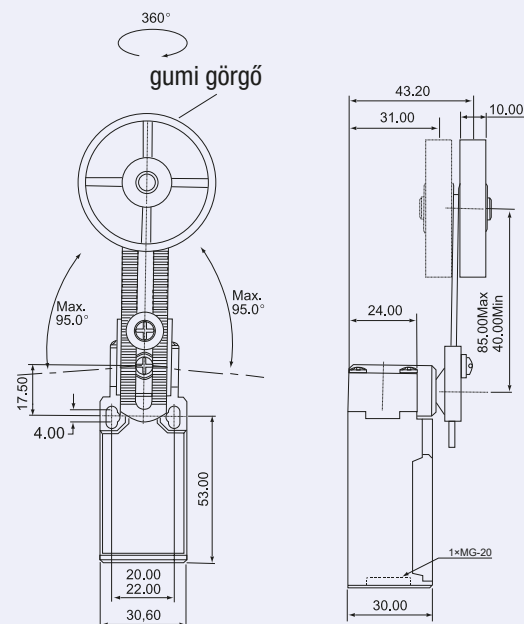
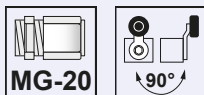

TRACON VP191



Lengőkaros kivitel

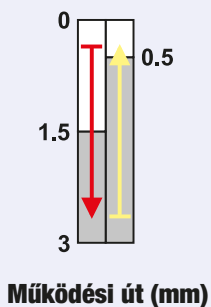
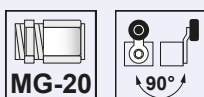

d = 12,7 mm
fém görgő

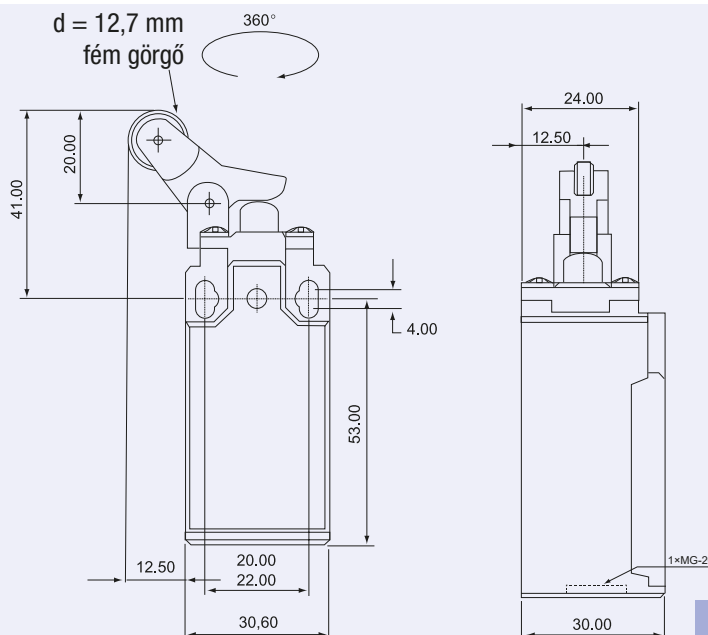

TRACON VP127



VT helyzetkapcsolók

I_{th} 10 A	I_e (AC 1, 230 V) 5 A	I_e (AC 15, 230 V) 2 A	I_e (DC 13, 220 V) 0,3 A	U_i 500 V	[mm²] 0,75-1,5	x10⁷ x1.800	ON-OFF-ON... sc/h x1.800	T_a -25...+55°C	IP 65
-------------------------------	---	--	--	-------------------------------	-------------------------------------	----------------------------------	---------------------------------------	-------------------------------------	-----------------

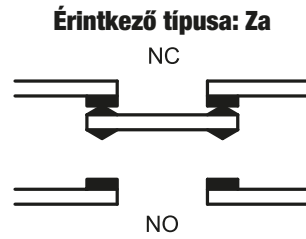
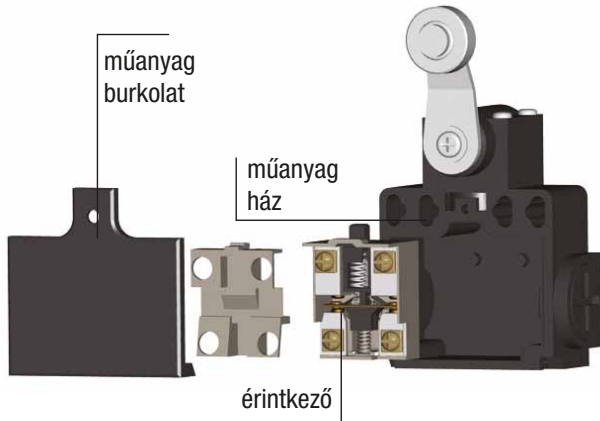

RELEVANT STANDARD
EN 60947-1

RELEVANT STANDARD
EN 60947-5-1

- Dupla érintkezők
- Erős műanyag burkolat
- Masszív szerkezet
- Precíz kapcsolás
- Hosszú élettartam

Görgős ütközős kivitel

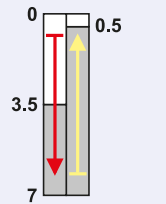
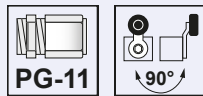

Működési út (mm)

TRACON VT102

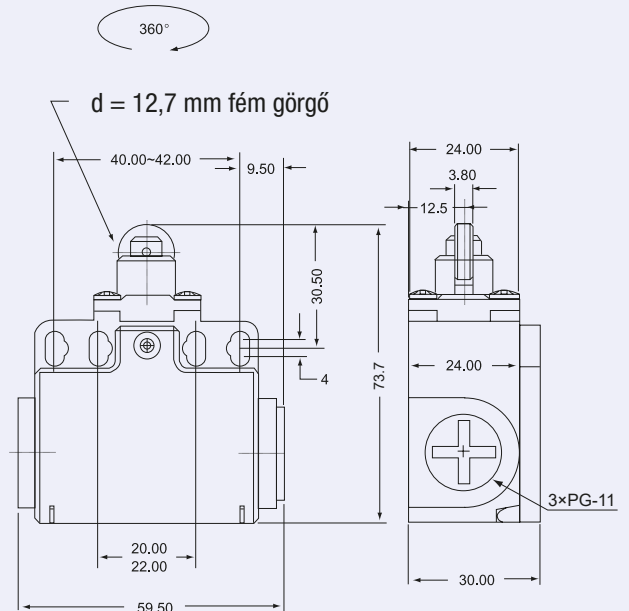

Kúpos ütközős kivitel

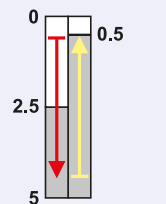
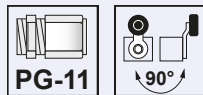

Működési út (mm)

TRACON VT110

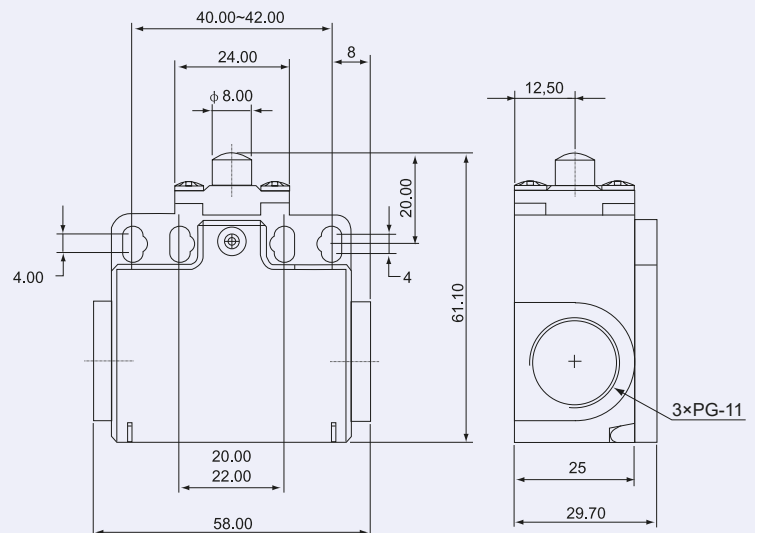

Lengőkaros kivitel

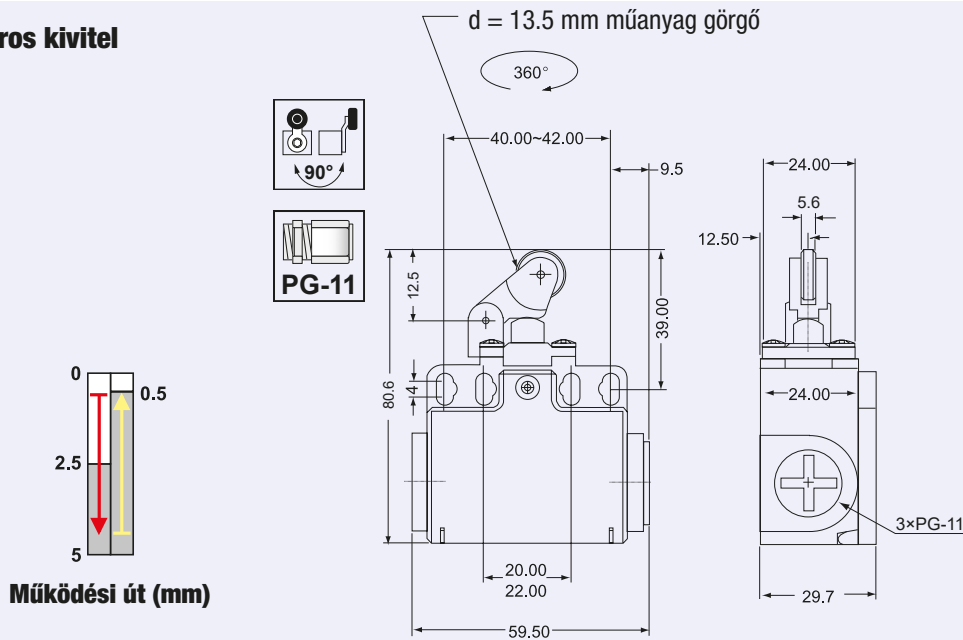

TRACON VT121

Lengőkaros, görgős kivitel

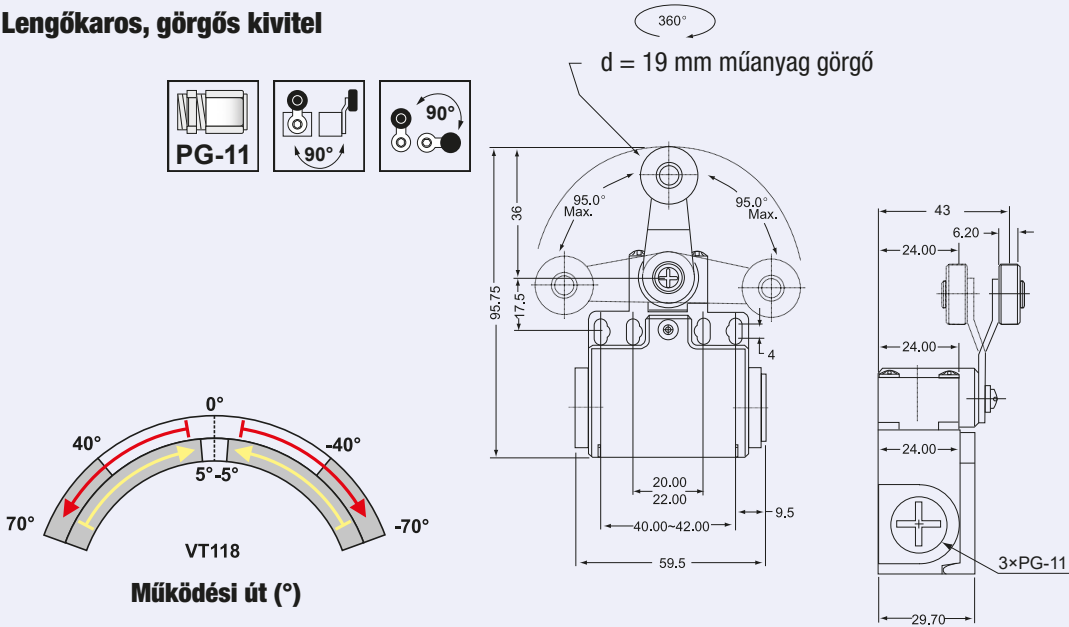

TRACON VT118

Állítható görgőkapcsolós kivitel

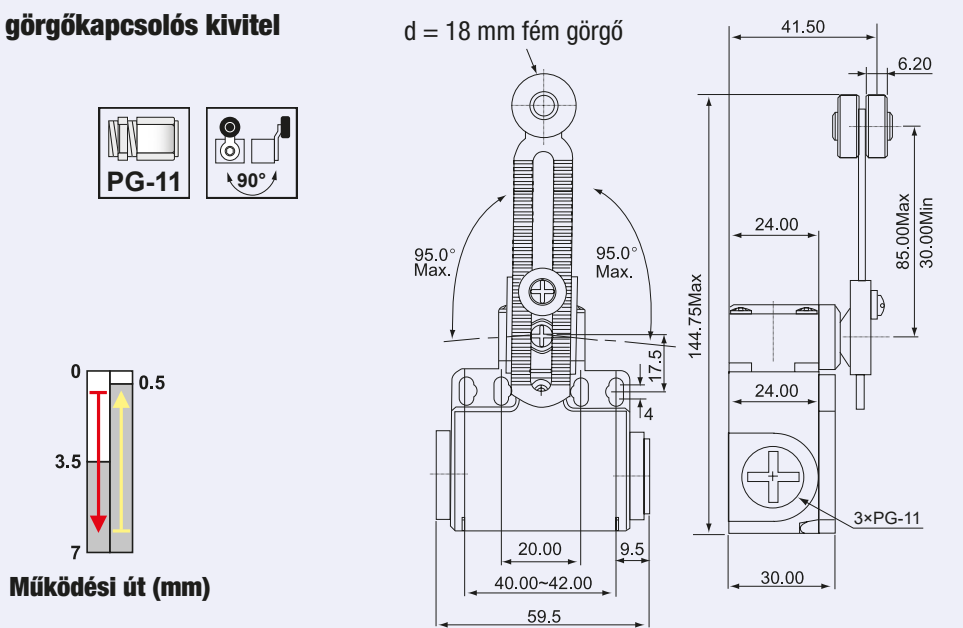

TRACON VT145

Rúgózárás kivitel

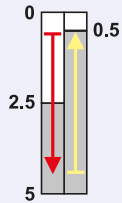
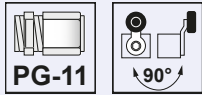

Működési út (mm)

TRACON VT181

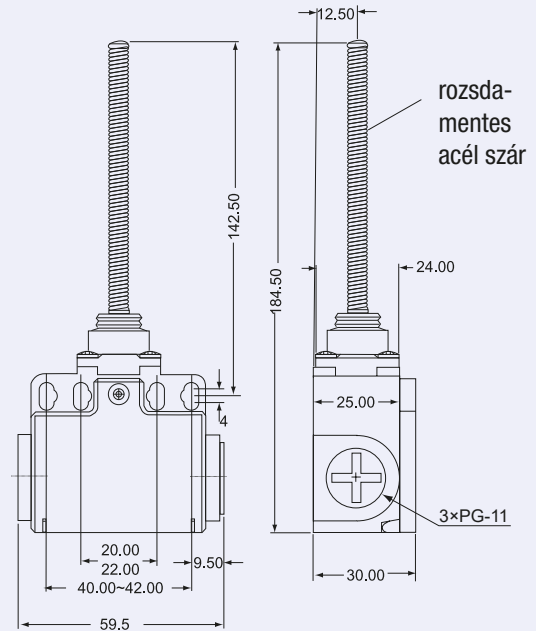

Rúgózárás pálcás kivitel

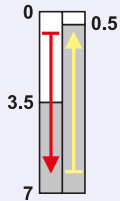
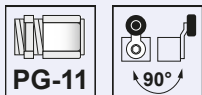

Működési út (mm)

TRACON VT106

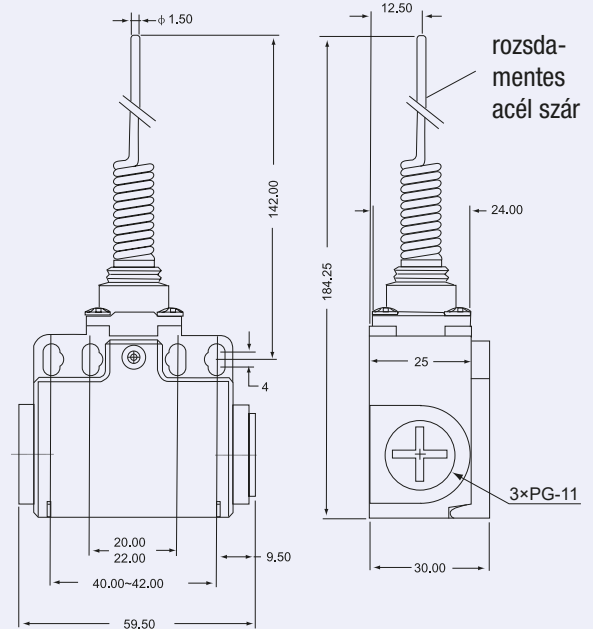

Lengőkaros kivitel

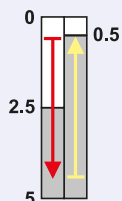
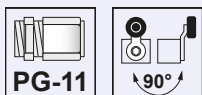

Működési út (mm)

TRACON VT127

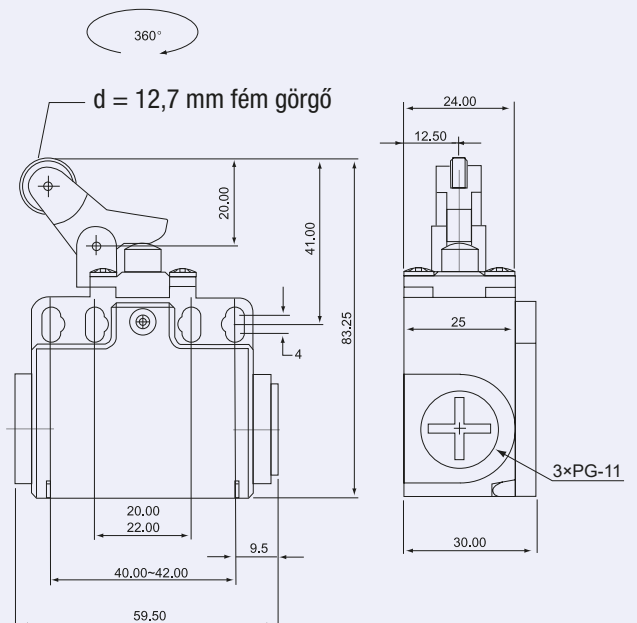

rúgószáras, műanyag-pálcás kivitel

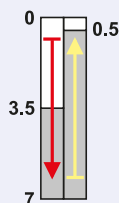
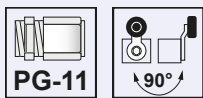

Működési út (mm)

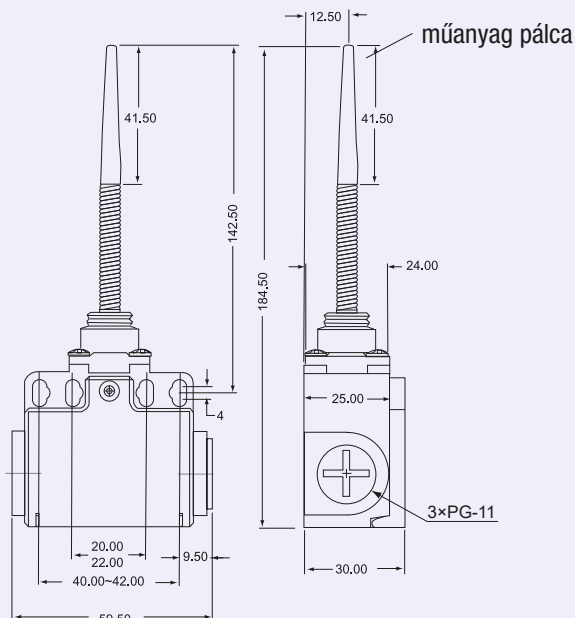

TRACON VT171

Gumigörgős kivitel

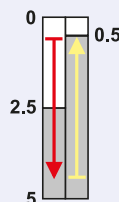
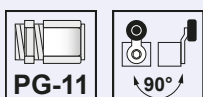

Működési út (mm)

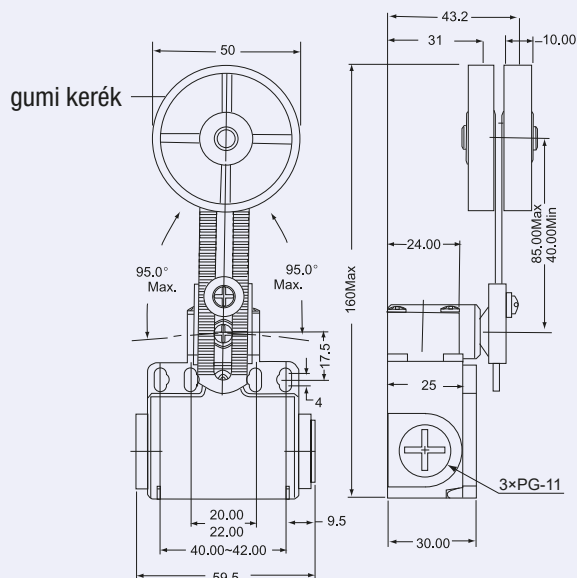

TRACON VT191

**MP
JELŐLŐ- ÉS
MÉRŐPLOMBÁK**



TRACON
ELECTRIC®

C/24

VM helyzetkapcsolók

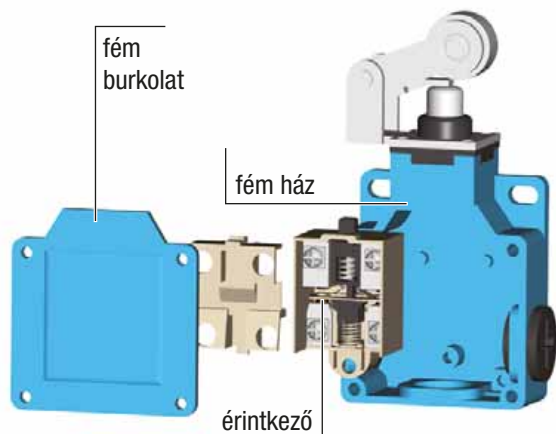
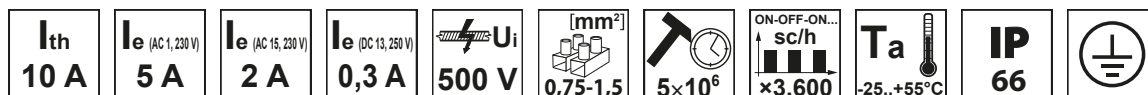

Érintkező típusa: Za

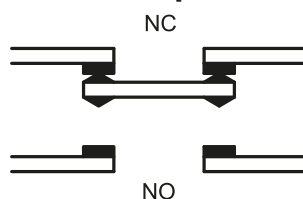

- Dupla érintkezők
- Erős fém burkolat
- Masszív szerkezet
- Vízálló és olajálló
- Hosszú élettartam
- Könnyen vezetékezzhető

RELEVANT STANDARD
EN 60947-1

RELEVANT STANDARD
EN 60947-5-1

Kúpos ütközős kivitel

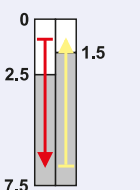
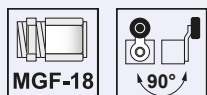

Működési út (mm)

TRACON VM110

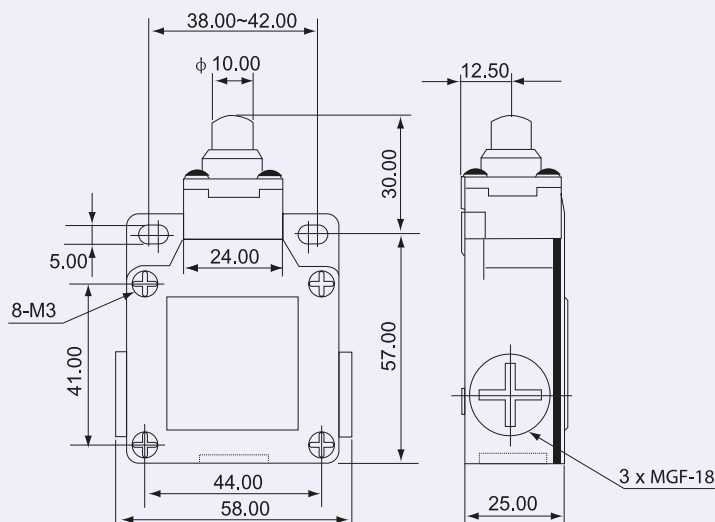

Göngös ütközős kivitel

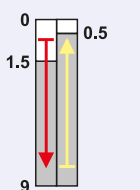
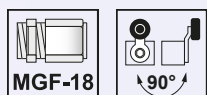

Működési út (mm)

TRACON VM102

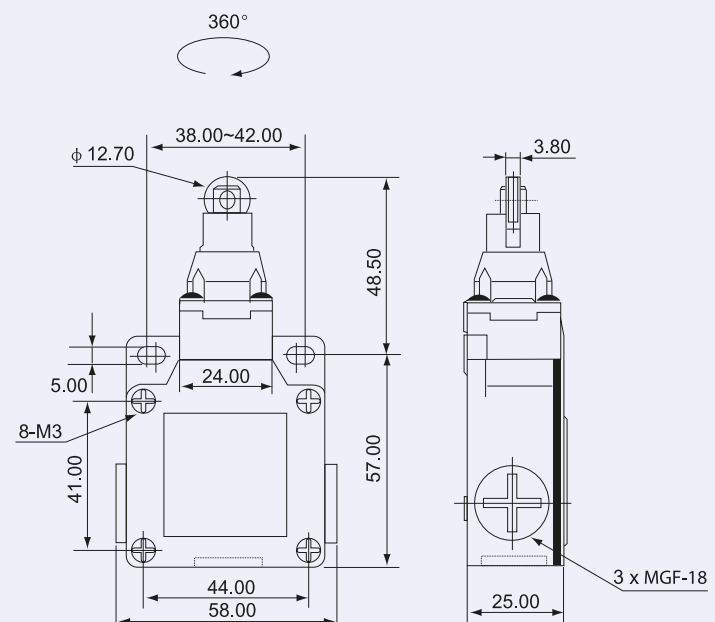

Görgős, karos ütközős kivitel

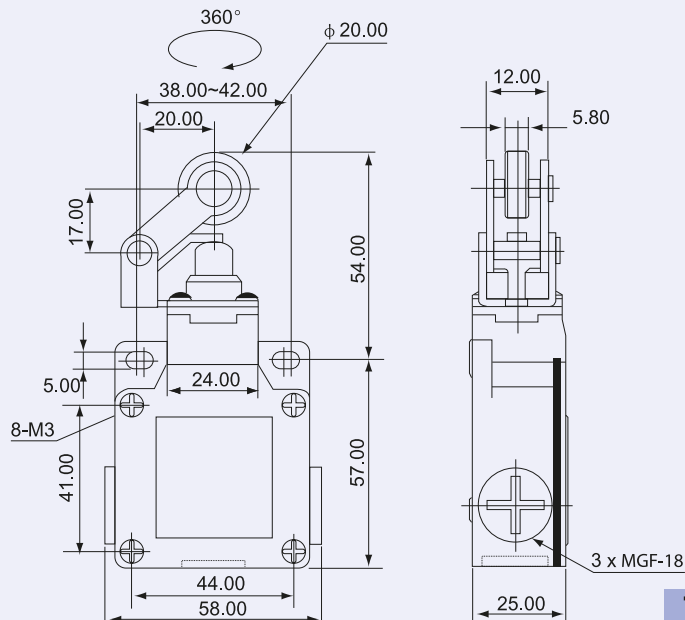
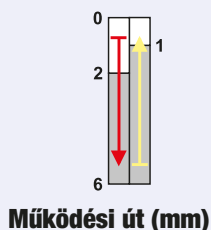
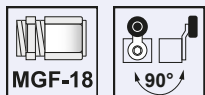

TRACON VM121

Lengőkaros kivitel

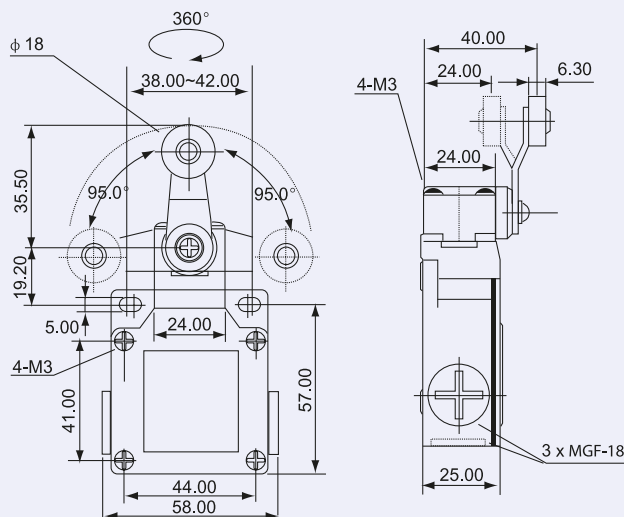
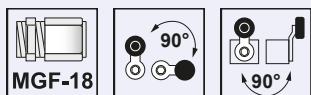

TRACON VM115

Rugós, pálcás kivitel

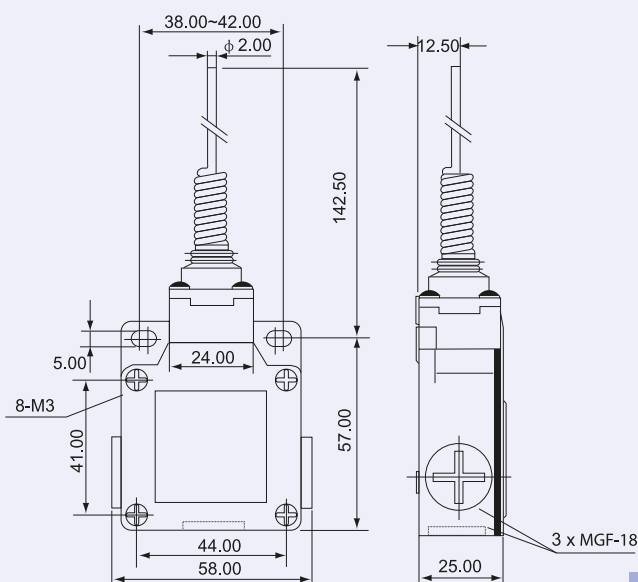
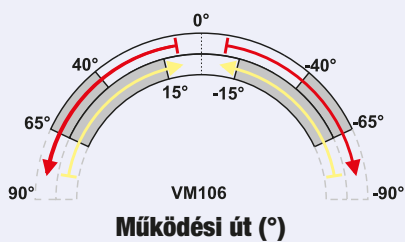
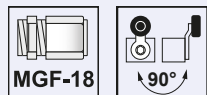

TRACON VM106

Állítható görgőkaros kivitel

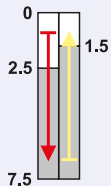
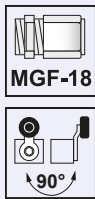

Működési út (mm)

TRACON VM145

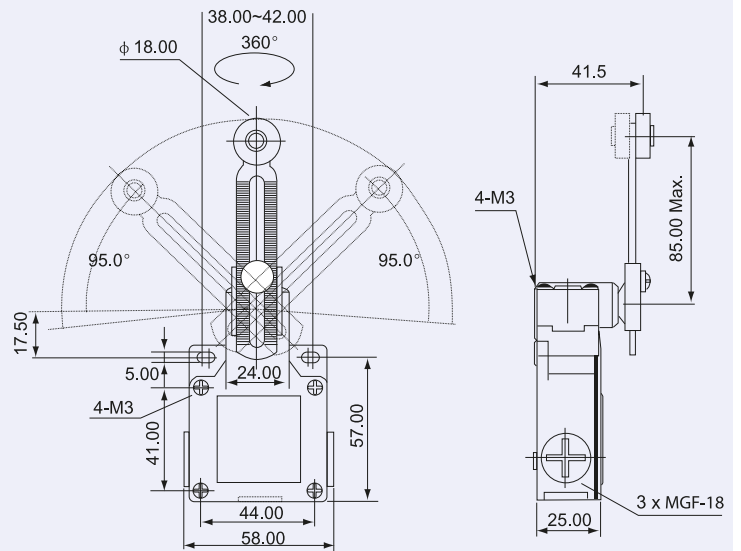

Rúgózárás, műanyag-pálcás kivitel

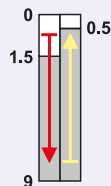
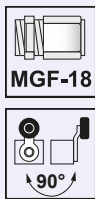

Működési út (mm)

TRACON VM171

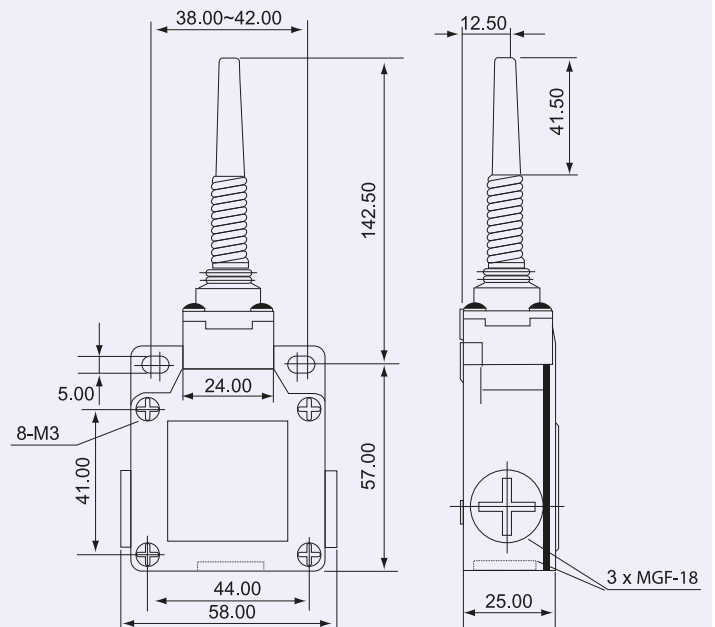

Rúgózárás kivitel

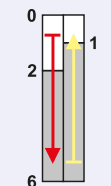
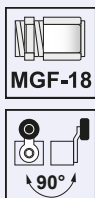

Működési út (mm)

TRACON VM181

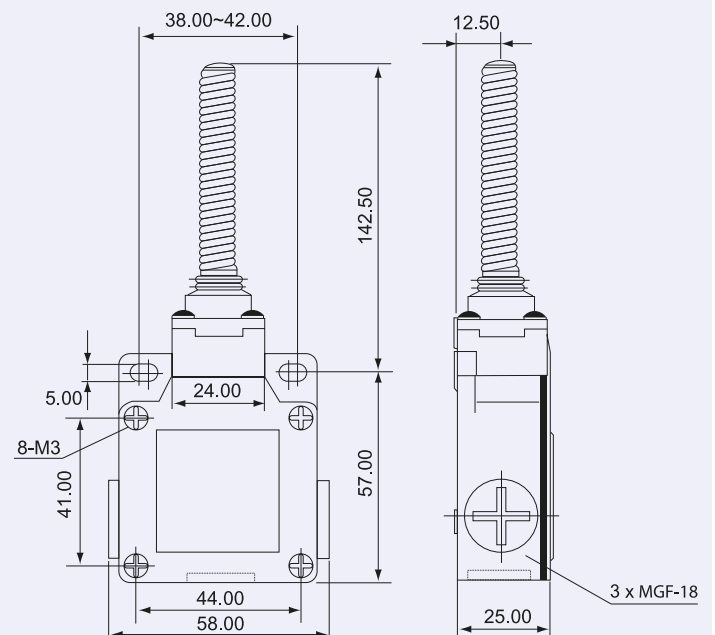

RSMDL
LED FÉNYVETŐK

TRACON
ELECTRIC®



E/23-E/25

KW helyzetkapcsolók (mikrokapcsolók)

I_{th} 10 A	I_e (AC 1, 230 V) 5 A	I_e (AC 15, 230 V) 2 A	I_e (DC 13, 250 V) 0,3 A	U_i 500 V	[mm²] 0,75-1,5	sc/h ×600	T_a -25...+80°C	IP 00
-------------------------------	---	--	--	-------------------------------	-------------------------------------	---------------------	-------------------------------------	-----------------

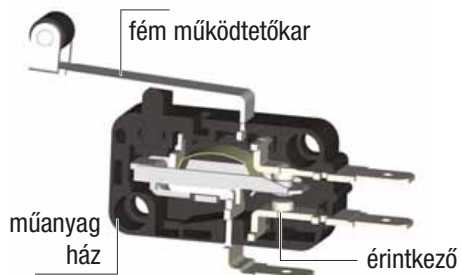

Érintkező típusa: C

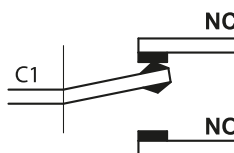

RELEVANT STANDARD
EN 60947-1

RELEVANT STANDARD
EN 60947-5-1

Ütközős kivitel

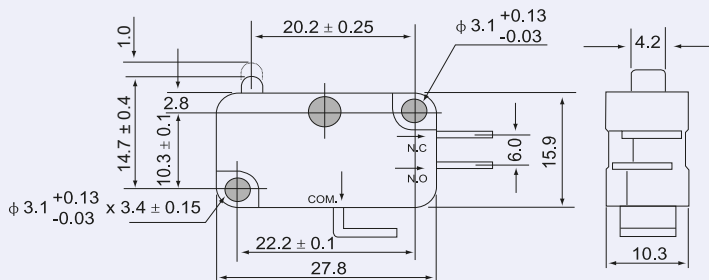
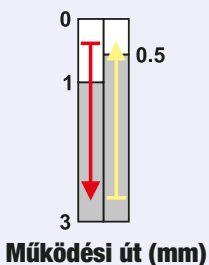

TRACON

KW3-01 6,3×0,8 mm

KW3-05 4,8×0,5 mm

Rugózáras kivitel

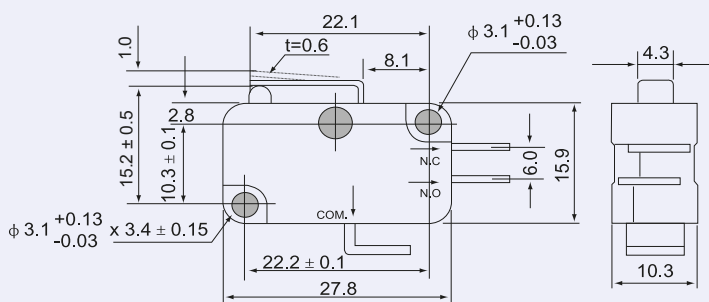
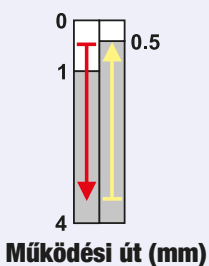

TRACON

KW3-11 6,3×0,8 mm

KW3-15 4,8×0,5 mm

Rugózáras kivitel

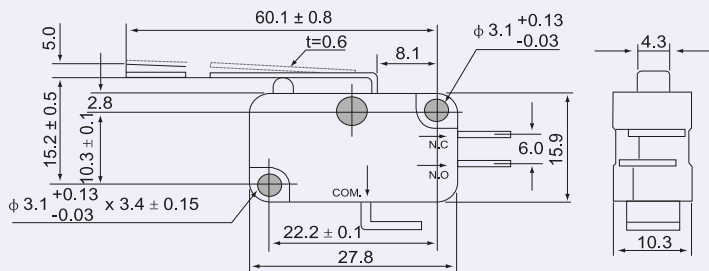
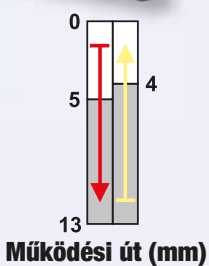

TRACON

KW3-21 6,3×0,8 mm

KW3-25 4,8×0,5 mm

Rugószáras kivitel

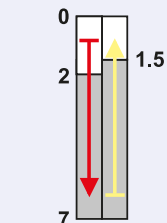

Működési út (mm)

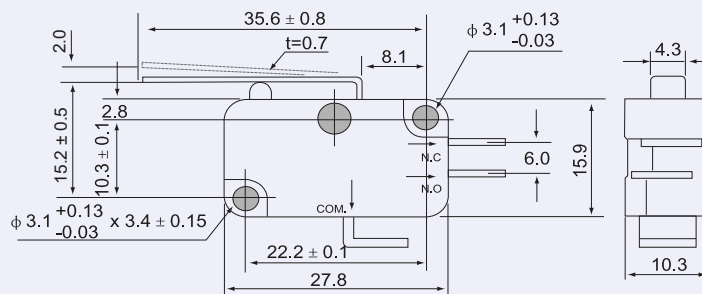

TRACON

KW3-31	6,3×0,8 mm
KW3-35	4,8×0,5 mm

Rugószáras görgős kivitel

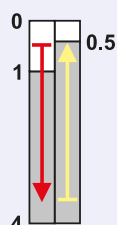

Működési út (mm)

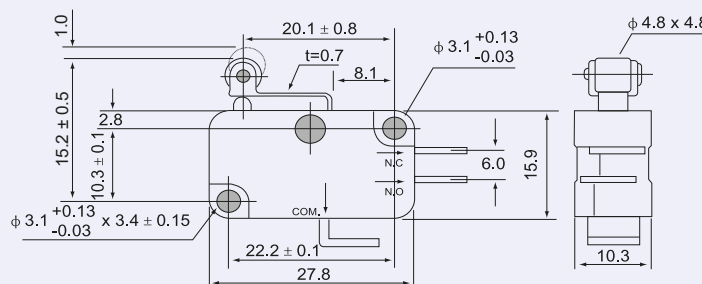

TRACON

KW3-41	6,3×0,8 mm
KW3-45	4,8×0,5 mm

Rugószáras görgős kivitel

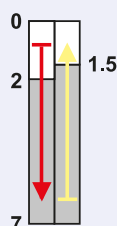

Működési út (mm)

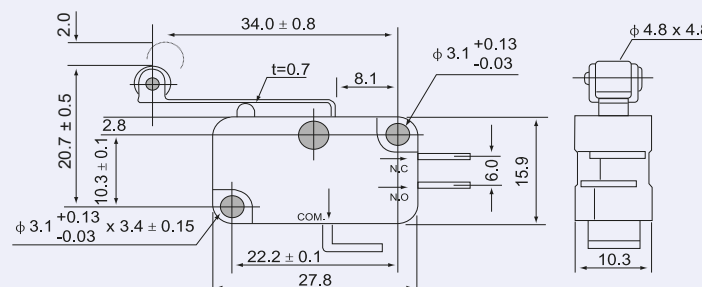

TRACON

KW3-51	6,3×0,8 mm
KW3-55	4,8×0,5 mm

Rugószáras kivitel

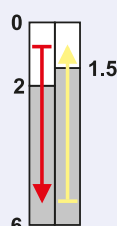

Működési út (mm)

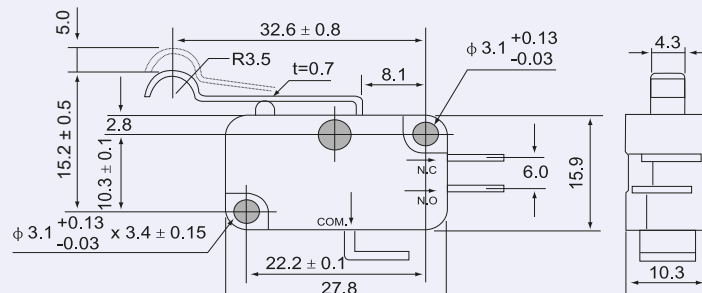

TRACON

KW3-61	6,3×0,8 mm
KW3-65	4,8×0,5 mm

Egyszerű nyomógombok

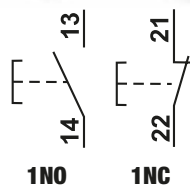

TRACON

IP 65
 IP65
 NC
 NO

NYG3-BK		1 × NO
NYG3-G		1 × NO
NYG3-W		1 × NO
NYG3-Y		1 × NO
NYG3-B		1 × NO
NYG3-R		1 × NC

page K/32

RELEVANT STANDARD EN 60947-1

RELEVANT STANDARD EN 60947-5-1

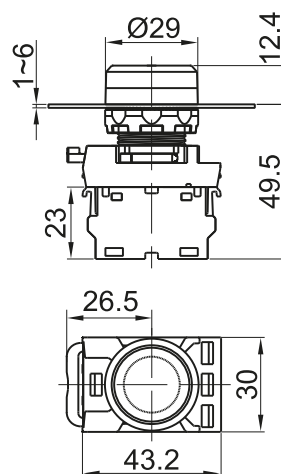

Egyszerű nyomókapcsoló

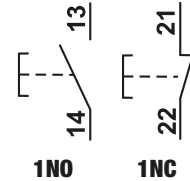

TRACON

IP 65
 IP65
 NC
 NO

NYK3-BK		1 × NO
NYK3-G		1 × NO
NYK3-W		1 × NO
NYK3-Y		1 × NO
NYK3-B		1 × NO
NYK3-R		1 × NC

page K/32

RELEVANT STANDARD EN 60947-1

RELEVANT STANDARD EN 60947-5-1

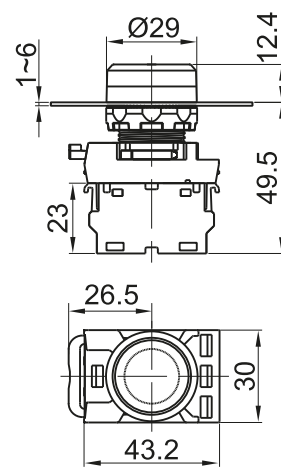

Kiálló nyomógomb

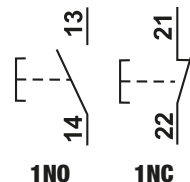

TRACON

IP 42
 IP42
 NC
 NO

NYG3-HBK		1 × NO
NYG3-HG		1 × NO
NYG3-HW		1 × NO
NYG3-HY		1 × NO
NYG3-HB		1 × NO
NYG3-HR		1 × NC

page K/32

RELEVANT STANDARD EN 60947-1

RELEVANT STANDARD EN 60947-5-1

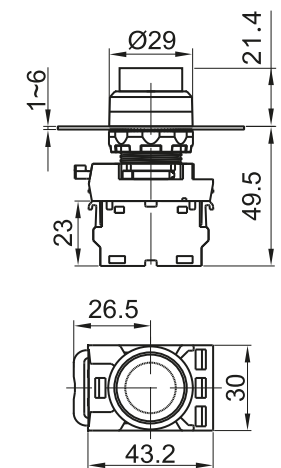

Kiálló nyomókapcsoló



I_e (AC 1, 230 V) 6 A	I_e (AC 15, 230 V) 3 A	I_e (DC 13, 230 V) 0,27 A	U_i 660 V	$[mm^2]$ 0,5-2,5	$\times 10^6$	F_{on} max. 20 N	F_{off} max. 15 N	T_a -25..+40°C		
-----------------------------------	------------------------------------	---------------------------------------	-----------------------	----------------------------	---------------	------------------------------	-------------------------------	----------------------------	--	--

TRACON

IP 42

IP42

NC
NO

NYK3-HBK			1 × NO
NYK3-HG			1 × NO
NYK3-HW		page K/32	1 × NO
NYK3-HY			1 × NO
NYK3-HB			1 × NO
NYK3-HR			1 × NC

RELEVANT STANDARD EN 60947-1

RELEVANT STANDARD EN 60947-5-1

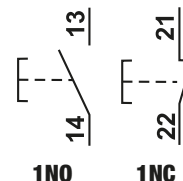
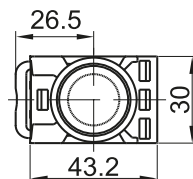
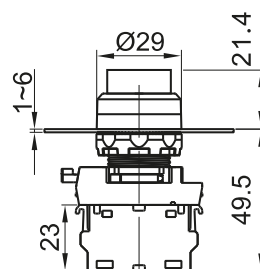

Világító nyomógomb



I_e (AC 1, 230 V) 6 A	I_e (AC 15, 230 V) 3 A	I_e (DC 13, 230 V) 0,27 A	U_i 660 V	$[mm^2]$ 0,5-2,5	$\times 10^6$	F_{on} max. 20 N	T_a -25..+40°C			
-----------------------------------	------------------------------------	---------------------------------------	-----------------------	----------------------------	---------------	------------------------------	----------------------------	--	--	--

TRACON

IP 65

IP65

NC
NO

NYG3-LG			1 × NO
NYG3-LW			1 × NO
NYG3-LY			1 × NO
NYG3-LB			1 × NO
NYG3-LR		page K/32	1 × NC
NYG3-HLG*			1 × NO
NYG3-HLW*			1 × NO
NYG3-HLY*			1 × NO
NYG3-HLB*			1 × NO
NYG3-HLR*			1 × NC

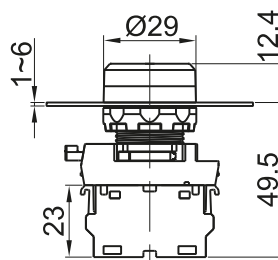

NYG3-L..

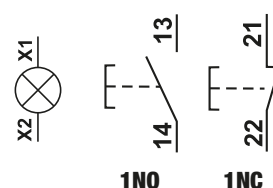
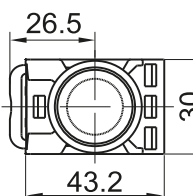

* Kiálló típus változatok, IP 42

RELEVANT STANDARD EN 60947-1

RELEVANT STANDARD EN 60947-5-1

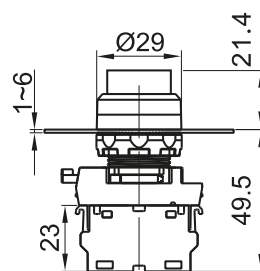

NYG3-H..

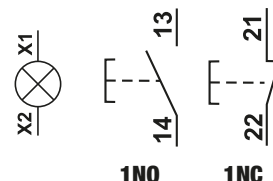
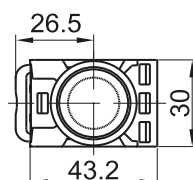

Világító nyomókapcsoló

I_e (AC 1, 230 V) 6 A
 I_e (AC 15, 230 V) 3 A
 I_e (DC 13, 250 V) 0,27 A
 U_i 660 V
 mm^2 0,5-2,5
 $\times 10^6$
 F_{on} max. 20 N
 F_{off} max. 15 N
 T_a -25...+40°C
22 mm
Ba9s



NYK3-L..

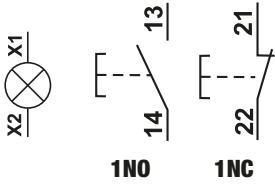

TRACON		IP 65	IP65	NC NO
NYK3-LG				1 x NO
NYK3-LW				1 x NO
NYK3-LY				1 x NO
NYK3-LB				1 x NO
NYK3-LR				1 x NC
NYK3-HLG*				1 x NO
NYK3-HLW*				1 x NO
NYK3-HLY*				1 x NO
NYK3-HLB*				1 x NO
NYK3-HLR*				1 x NC

page K/32

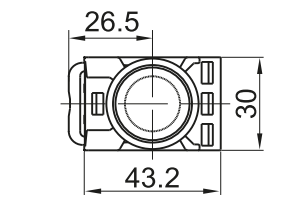
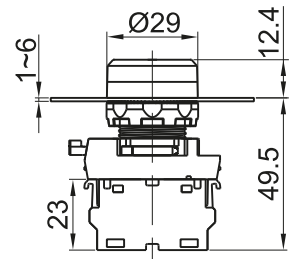

NYK3-H..

RELEVANT STANDARD
EN 60947-1

RELEVANT STANDARD
EN 60947-5-1

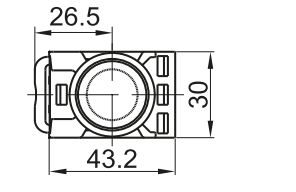
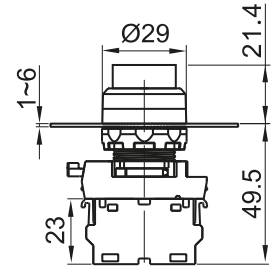

* Kiálló típus változatok (IP42)

Jelölt nyomógomb

I_e (AC 1, 230 V) 6 A
 I_e (AC 15, 230 V) 3 A
 I_e (DC 13, 250 V) 0,27 A
 U_i 660 V
 mm^2 0,5-2,5
 $\times 10^6$
 F_{on} max. 20 N
 T_a -25...+40°C
22 mm



NYG3-P..

TRACON		IP 65	IP65	NC NO
NYG3-P1	I			1 x NO
NYG3-P4	→			1 x NO
NYG3-P3	→			1 x NO
NYG3-P2	0			1 x NC
NYG3-P1L	I			1 x NO
NYG3-P4L	→			1 x NO
NYG3-P3L	→			1 x NO
NYG3-P2L	0			1 x NC

page K/32

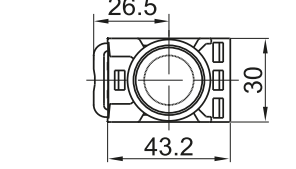
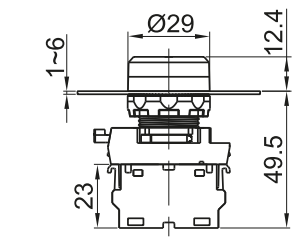

NYG3-P..L

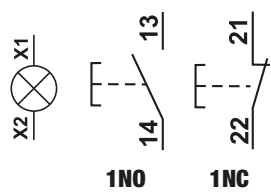

K/32

Jelölt nyomókapcsoló



I_e (AC 1, 230 V) 6 A	I_e (AC 15, 230 V) 3 A	I_e (DC 13, 250 V) 0,27 A	U_i 660 V	$[mm^2]$ 0,5-2,5	$\times 10^6$	F_{on} max. 20 N	F_{off} max. 15 N	T_a -25...+40°C		
-----------------------------------	------------------------------------	---------------------------------------	-----------------------	----------------------------	---------------	------------------------------	-------------------------------	-----------------------------	--	--

TRACON

IP 65

IP65

NC
NO

NYK3-P1		I	1 × NO
NYK3-P4		→	1 × NO
NYK3-P3		→	1 × NO
NYK3-P2		0	1 × NC
NYK3-P1L		I	1 × NO
NYK3-P4L		→	1 × NO
NYK3-P3L		→	1 × NO
NYK3-P2L		0	1 × NC

page K/32

Ba9s

RELEVANT STANDARD EN 60947-1

RELEVANT STANDARD EN 60947-5-1

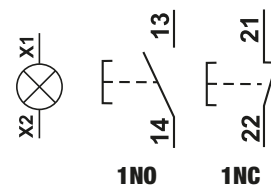
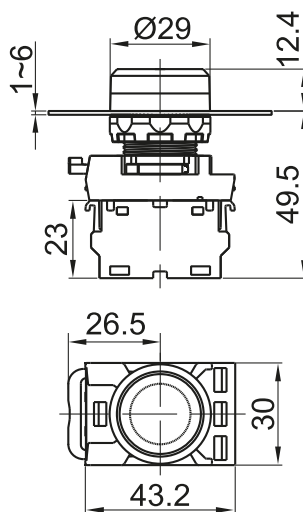

Gombafejű nyomógomb



I_e (AC 1, 230 V) 6 A	I_e (AC 15, 230 V) 3 A	I_e (DC 13, 250 V) 0,27 A	U_i 660 V	$[mm^2]$ 0,5-2,5	$\times 10^4$	F_{on} max. 20 N	F_{off} max. 15 N	T_a -25...+40°C		
-----------------------------------	------------------------------------	---------------------------------------	-----------------------	----------------------------	---------------	------------------------------	-------------------------------	-----------------------------	--	--

TRACON

IP 65

IP65

NC
NO

NYG3-MBK			1 × NO
NYG3-MG			1 × NO
NYG3-MY			1 × NO
NYG3-MB			1 × NO
NYG3-MR			1 × NC
NYG3-MLG			1 × NO
NYG3-MLY			1 × NO
NYG3-MLB			1 × NO
NYG3-MLR			1 × NC

page K/32

Ba9s

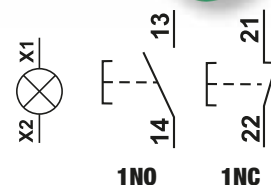
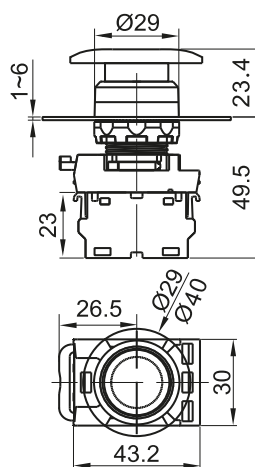

Vészgomb, reteszelt

I_e (AC 1, 230 V) 6 A	I_e (AC 15, 230 V) 3 A	I_e (DC 13, 250 V) 0,27 A	U_i 660 V	$[mm^2]$ 0,5-2,5	$\times 10^4$	F_{on} max. 20 N	F_{off} max. 15 N	T_a -25...+40°C	
-----------------------------------	------------------------------------	---------------------------------------	-----------------------	----------------------------	---------------	------------------------------	-------------------------------	-----------------------------	--

TRACON

IP 65

IP65

NC
NO

NYG3-ETR			1 × NC
NYG3-ETLR		STOP	1 × NC

page K/32

Ba9s

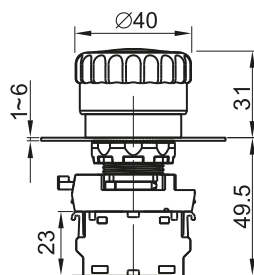

RELEVANT STANDARD EN 60947-1

RELEVANT STANDARD EN 60947-5-1

Kettős, be-ki nyomógomb

I_e (AC 1, 230 V)
6 A

I_e (AC 15, 230 V)
3 A

I_e (DC 13, 250 V)
0,27 A

U_i
660 V

[mm²]
0,5-2,5

$\times 10^6$

F_{on}
max. 20 N

T_a
-25..+40°C

22 mm

22 mm

Piktogramok K/O



TRACON		IP 65		IP65		NC NO	
NYG3-D						1×NO+1×NC	
NYG3-D1	I	O				1×NO+1×NC	
NYG3-D2	ON	OFF				1×NO+1×NC	
NYG3-DL						1×NO+1×NC	
NYG3-DL1	I	O				1×NO+1×NC	
NYG3-DL2	ON	OFF				1×NO+1×NC	

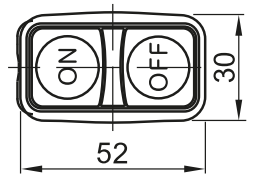
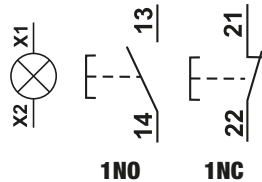
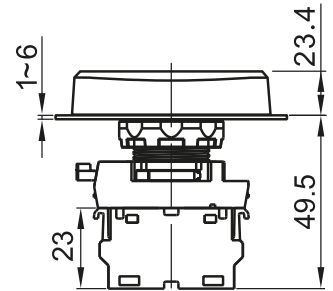

RELEVANT STANDARD
EN 60947-1

RELEVANT STANDARD
EN 60947-5-1

Karos kapcsoló

I_e (AC 1, 230 V)
6 A

I_e (AC 15, 230 V)
3 A

I_e (DC 13, 250 V)
0,27 A

U_i
660 V

[mm²]
0,5-2,5

30×10^4

T_a
-25..+40°C

22 mm

22 mm



TRACON		IP 65		IP65		NC NO	
Normál	NYK3-S21BK	∇ ²				1×NO+1×NC	
	NYK3-S31BK	∇ ^{0 2}				2 × NO	
	NYK3-S24BK	∇ ^{2 2}				1×NO+1×NC	
Rugó visszatérítéses	NYK3-S32BK	∇ ^{2 2}				2 × NO	
	NYK3-S33BK	∇ ^{1 2}				2 × NO	
	NYK3-S34BK	∇ ^{0 2}				2 × NO	

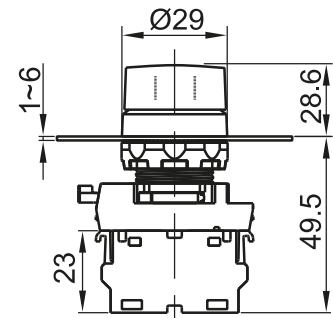

RELEVANT STANDARD
EN 60947-1

RELEVANT STANDARD
EN 60947-5-1

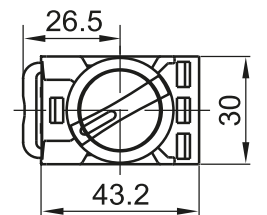

Kétállású normál

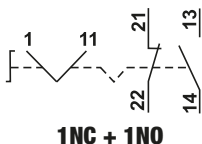

1NC + 1NO

Háromállású normál

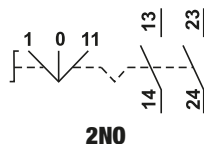

2NO

Kétállású rugóvisszatérítéses

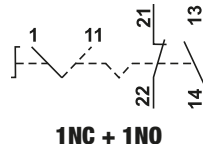

1NC + 1NO

Háromállású rugóvisszatérítéses



2NO

Világítókaros kapcsoló

I_e (AC 1, 230 V) 6 A	I_e (AC 15, 230 V) 3 A	I_e (DC 13, 250 V) 0,27 A	U_i 660 V	[mm²] 0,5-2,5	30×10⁴	T_a -25..+40°C	22 mm	Ba9s
--	---	--	--------------------------------------	---	--------------------------	---	--------------	-------------

TRACON

IP 65

IP65

NC
NO

NYK3-SL21R		1xNO+1xNC
NYK3-SL21G		1xNO+1xNC
NYK3-SL21Y		1xNO+1xNC
NYK3-SL21B		1xNO+1xNC
NYK3-SL24R		1xNO+1xNC
NYK3-SL24G		1xNO+1xNC
NYK3-SL24Y		1xNO+1xNC
NYK3-SL24B		1xNO+1xNC
NYK3-SL31R		1xNO+1xNC
NYK3-SL31G		1xNO+1xNC
NYK3-SL31Y		1xNO+1xNC
NYK3-SL31B		1xNO+1xNC
NYK3-SL34R		1xNO+1xNC
NYK3-SL34G		1xNO+1xNC
NYK3-SL34Y		1xNO+1xNC
NYK3-SL34B		1xNO+1xNC

page K/32

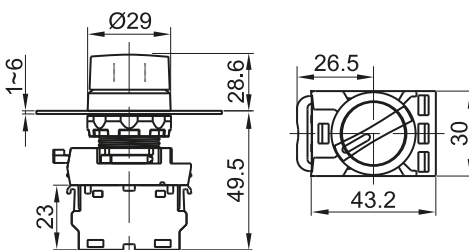
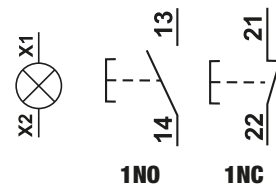
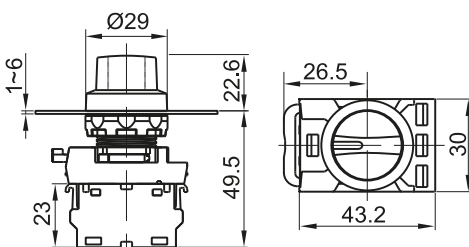

Kulcsos kapcsoló

I_e (AC 1, 230 V) 6 A	I_e (AC 15, 230 V) 3 A	I_e (DC 13, 250 V) 0,27 A	U_i 660 V	[mm²] 0,5-2,5	5×10⁴	T_a -25..+40°C	22 mm
--	---	--	--------------------------------------	---	-------------------------	---	--------------

Piktogramok **K/0**

TRACON

IP 42

IP42

NC
NO

Normál	NYK3-K21		1xNO+1xNC
	NYK3-K31		1xNO+1xNC
Rugó	NYK3-K24		1xNO+1xNC
visszatérítéses	NYK3-K34		1xNO+1xNC

page K/32

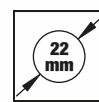

Kétállású normál

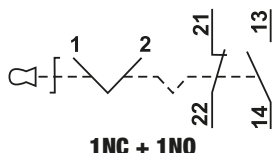

Háromállású normál

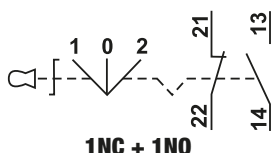

Kétállású rugóvisszatérítéses

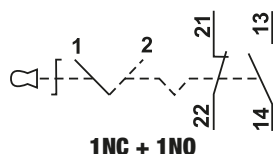

Háromállású rugóvisszatérítéses

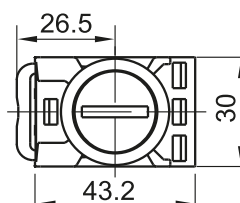
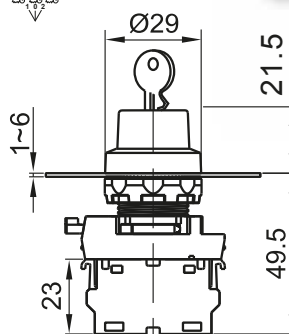
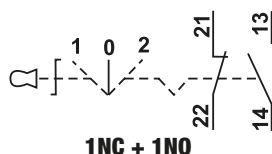

RELEVANT STANDARD
EN 60947-1
EN 60947-5-1

Érintkező egység NYG(K)3 sorozathoz

I_e (AC 1, 230 V) 6 A	I_e (AC 15, 230 V) 3 A	I_e (DC 13, 250 V) 0,27 A	U_i 660 V	[mm²] 0,5-2,5	x10⁶	T_a -25..+40°C	
--	---	--	--------------------------------------	---	------------------------	---	--

Piktogramok K/O



TRACON				
NYG3-CE1				1 x NO
NYG3-CE2				1 x NC

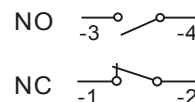

Ba9s foglalat NYG(K)3 sorozathoz

U_i 660 V	[mm²] 0,5-2,5	T_a -25..+40°C	
--------------------------------------	---	---	--



TRACON				
NYG3-SOC		IP 42		Ba9s

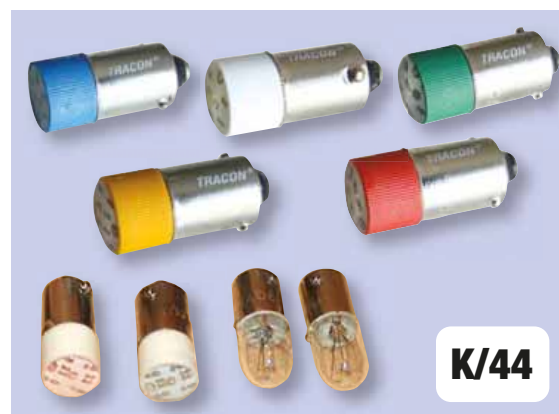
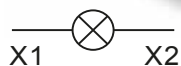

K/44

Tokozat

T_a -25..+40°C		IP 65	% rH max. 90	22 mm
---	--	--------------	-------------------------------	--------------



TRACON				L x W x H (mm)
NYGD-1GR				70 x 90 x 65
NYGD-1YE				70 x 90 x 65
NYGD-2GR				70 x 127 x 65
NYGD-2YE				70 x 127 x 65
NYGD-3GR				70 x 167 x 65
NYGD-3YE				70 x 167 x 65

TRACON				L x W x H (mm)
NYGD-4GR				70 x 207 x 65
NYGD-4YE				70 x 207 x 65
NYGD-5GR				70 x 247 x 65
NYGD-5YE				70 x 247 x 65
NYGD-6GR				70 x 287 x 65
NYGD-6YE				70 x 287 x 65



NYGD-1GR



NYGD-2YE



NYGD-3GR

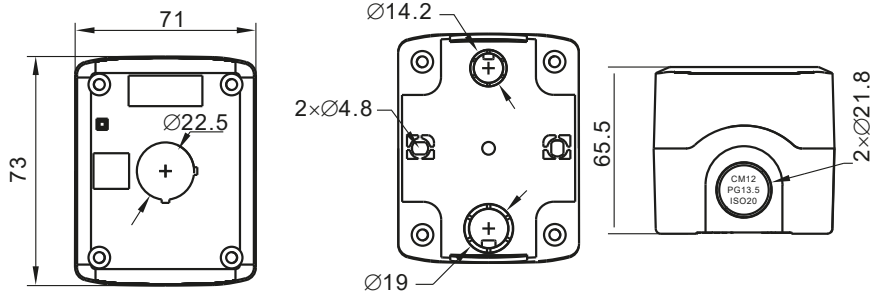

NYGD-4YE

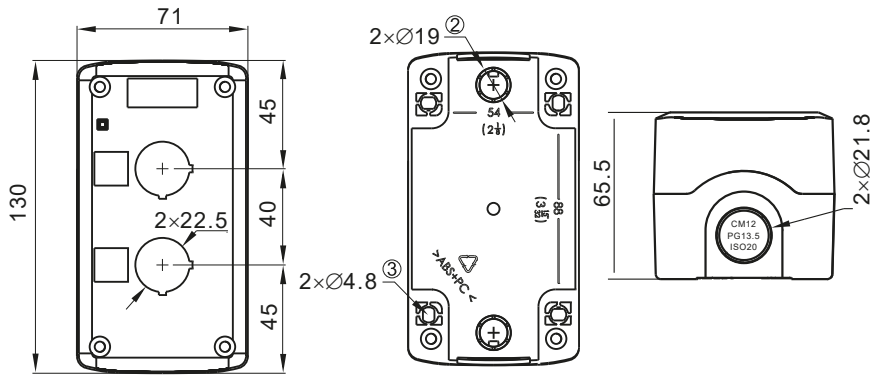

NYGD-5GR

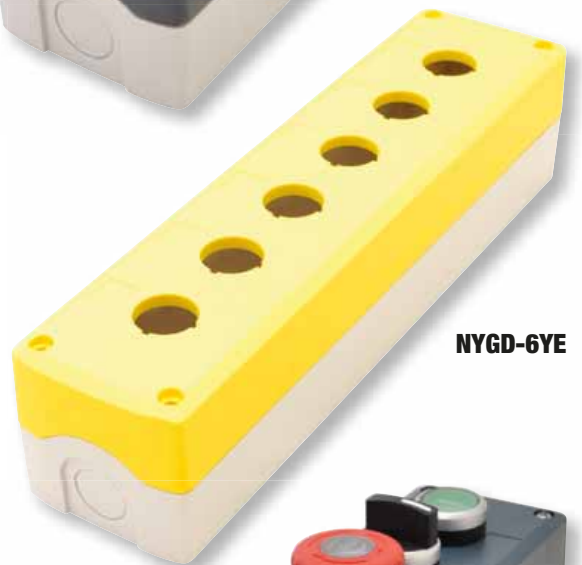
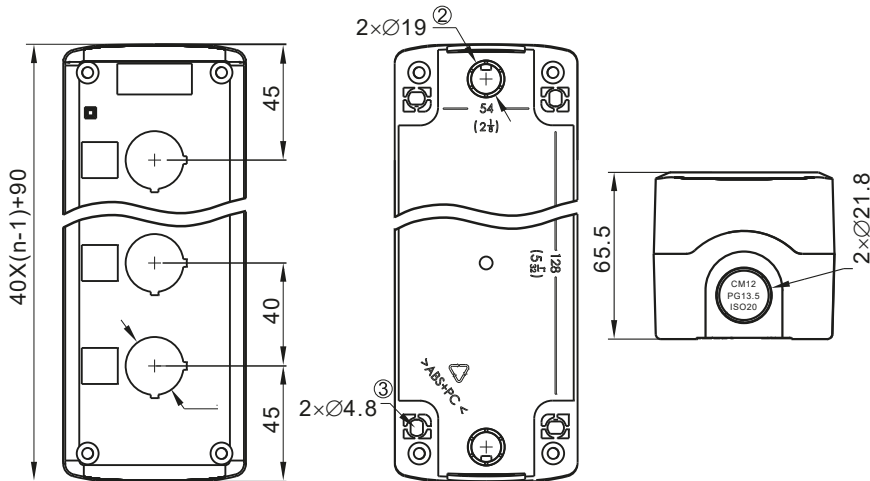

NYGD-6YE



Kiegészítők

TRACON		
NYG3-CAP	Védősapka, d=22 mm; h=16 mm; SILICA GEL	
NYG3-CAPH	Védősapka, d=22 mm; h=22 mm; SILICA GEL	
NYG3-LHB	Felirati tábla (hátdalról pattintható), 25×10 mm; ABS	
NYG3-LHBH	Felirati tábla (hátdalról pattintható), 25×17 mm; ABS	
NYG3-LHS	Felirati tábla (oldalról csúsztatható), 25×10 mm; ABS	
NYG3-LHSH	Felirati tábla (oldalról csúsztatható), 25×17 mm; ABS	
NYG3-BLP	Vakdugó, d=22 mm; ABS	
NYGR25/22	Szűkítőgyűrű, D=25 mm / d=22 mm; ABS (1 db)	
NYGR30/22	Szűkítőgyűrű, D=30 mm-ről d=22 mm-re (1 pár)	
NYGR38/22	Szűkítőgyűrű, D=38 mm-ről d=22 mm-re (1 pár)	
NYG3-SCAP	Plombálható sapka, D=30 mm/d=22 mm; h=20 mm; POLYCARBONATE	
NYG3-LCAP	Lakatosható sapka, D=50 mm/d=22 mm; h=32 mm; POLYCARBONATE	
NYG3-ES60	EMERGENCY STOP lap, d=60 mm; h=2 mm; ABS	
NYG3-ES60H	EMERGENCY STOP lap, magasított, d=60 mm; h=8 mm; ABS	
NYG3-ES90	EMERGENCY STOP lap, d=90 mm; h=2 mm; ABS	
NYG3-P30	Védőgallér kör-körös, d=30 mm; h=30 mm; ABS	
NYG3-PH30	Védőgallér fogazott, d=30 mm; h=28 mm; ABS	
NYG3-P60	Védőgallér kör-körös, d=60 mm; h=30 mm; ABS	
NYGD-FR	Rögzítő gyűrű NYGD-... tokozatokhoz, d=22 mm; ABS	
NYG3-PH65	Védőgallér íves, W=65 mm, H=80 mm, D=38 mm, ABS	



NYG3-CAP



NYG3-LH



NYG3-BLP



NYGR25/22



NYG3-SCAP



NYG3-LCAP



NYG3-ES..



NYP3-P..



NYG3-PH30



NYGD-FR



NYG3-PH65



NYGR3..



OLVASSA BE A KÓDOT!

- Nézze meg újdonságainkat
- Legyen naprakész

Kínálatunk gyorsan és folyamatosan fejlődik!
Katalógusunk a 2021. áprilisi állapotot tükrözi.
Naprakész információért
látogasson el honlapunkra!

Feszültség-, árammérők, hang- és fényjelzők

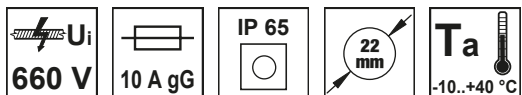

TRACON			Um	Im		
NYG3-VR		LED	24-500 V AC	-	-	
NYG3-VG		LED	24-500 V AC	-	-	
NYG3-VY		LED	24-500 V AC	-	-	
NYG3-AR		LED	-	1-100 A	-	
NYG3-AG		LED	-	1-100 A	-	
NYG3-AY		LED	-	1-100 A	-	
NYG3-BFR230	-	LED, blink	230 V AC	-	✓	
NYG3-BFR24	-	LED, blink	24 V AC/DC	-	✓	

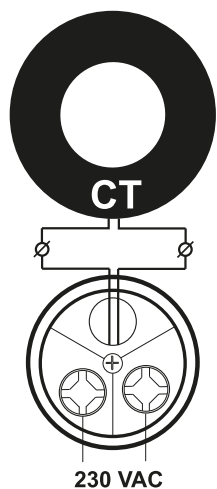

Fényjelző oszlopok

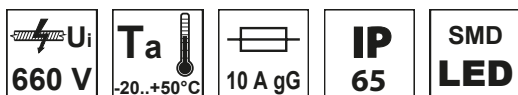

TRACON	Um		
NYG3-50RYG	AC 230 V		
NYG3-50RYGB	AC 230 V		
NYG3-50RYGBW	AC 230 V		
NYG3-50RYGM	AC/DC 24 V		
NYG3-50RYGBM	AC/DC 24 V		
NYG3-50RYGBWM	AC/DC 24 V		

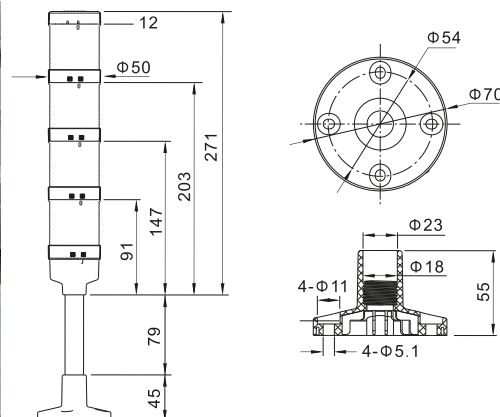

NYG3-50RYG NYG3-50RYGB NYG3-50RYGBW

LED-es jelzőlámpák



Piktogramok

K/0

Ø 16 mm-es változatok

Ø 22 mm-es változatok

TRACON		
IP 65		Um
LJL16-RA	Red	12 V AC/DC
LJL16-RC	Red	24 V AC/DC
LJL16-RD	Red	48 V AC/DC
LJL16-RE	Red	230 V AC/DC
LJL16-RF	Red	400 V AC
LJL16-GA	Green	12 V AC/DC
LJL16-GC	Green	24 V AC/DC
LJL16-GD	Green	48 V AC/DC
LJL16-GE	Green	230 V AC/DC
LJL16-GF	Green	400 V AC
LJL16-YA	Yellow	12 V AC/DC
LJL16-YC	Yellow	24 V AC/DC
LJL16-YD	Yellow	48 V AC/DC
LJL16-YE	Yellow	230 V AC/DC
LJL16-YF	Yellow	400 V AC
LJL16-WA	White	12 V AC/DC
LJL16-WC	White	24 V AC/DC
LJL16-WD	White	48 V AC/DC
LJL16-WE	White	230 V AC/DC
LJL16-WF	White	400 V AC
LJL16-BA	Blue	12 V AC/DC
LJL16-BC	Blue	24 V AC/DC
LJL16-BD	Blue	48 V AC/DC
LJL16-BE	Blue	230 V AC/DC
LJL16-BF	Blue	400 V AC

TRACON			
IP 65		Um	IP44
LJL22-RA	Red	12 V AC/DC	
LJL22-RC	Red	24 V AC/DC	
LJL22-RD	Red	48 V AC/DC	
LJL22-RE	Red	230 V AC/DC	
LJL22-RF	Red	400 V AC	
LJL22-GA	Green	12 V AC/DC	
LJL22-GC	Green	24 V AC/DC	
LJL22-GD	Green	48 V AC/DC	
LJL22-GE	Green	230 V AC/DC	
LJL22-GF	Green	400 V AC	
LJL22-YA	Yellow	12 V AC/DC	
LJL22-YC	Yellow	24 V AC/DC	
LJL22-YD	Yellow	48 V AC/DC	
LJL22-YE	Yellow	230 V AC/DC	
LJL22-YF	Yellow	400 V AC	
LJL22-WA	White	12 V AC/DC	
LJL22-WC	White	24 V AC/DC	
LJL22-WD	White	48 V AC/DC	
LJL22-WE	White	230 V AC/DC	
LJL22-WF	White	400 V AC	
LJL22-BA	Blue	12 V AC/DC	
LJL22-BC	Blue	24 V AC/DC	
LJL22-BD	Blue	48 V AC/DC	
LJL22-BE	Blue	230 V AC/DC	
LJL22-BF	Blue	400 V AC	

NYGD-1GR

page
K/32

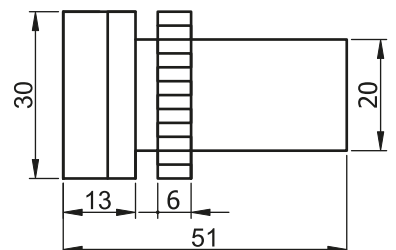
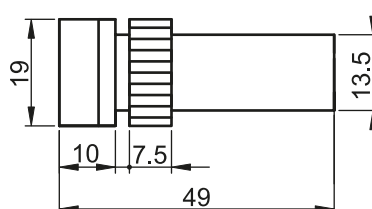

Egyszerű nyomógombok (fémalpra szerelt)



I_e (AC 1, 230 V) 6 A	I_e (AC 15, 230 V) 3 A	I_e (DC 13, 250 V) 0,27 A	U_i 660 V	$[mm^2]$ 0,5-2,5	$\times 10^6$	$F_{on I}$ max. 20 N	T_a -25..+70°C		
-----------------------------------	------------------------------------	---------------------------------------	-----------------------	----------------------------	---------------	--------------------------------	----------------------------	--	--

TRACON			
IP 42	+	IP42	IP65
NYGBA21	NYGBA21T		NYGD-1GR 1 × NO
NYGBA31Z	NYGBA31ZT		1 × NO
NYGBA51S	NYGBA51ST		1 × NO
NYGBA61K	NYGBA61KT		1 × NO
NYGBA42P	NYGBA42PT		1 × NC
			page K/32

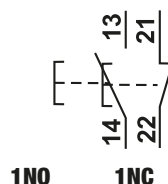
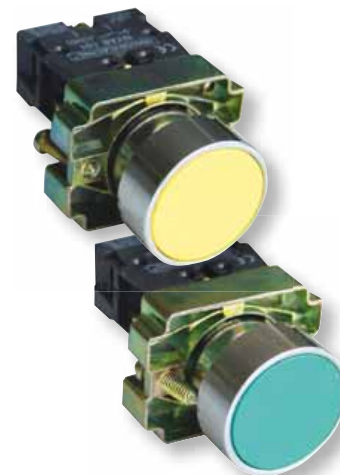
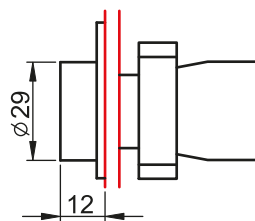

RELEVANT STANDARD
EN 60947-1

RELEVANT STANDARD
EN 60947-5-1

Kiálló nyomógombok (fémalpra szerelt)



I_e (AC 1, 230 V) 6 A	I_e (AC 15, 230 V) 3 A	I_e (DC 13, 250 V) 0,27 A	U_i 660 V	$[mm^2]$ 0,5-2,5	$\times 10^6$	$F_{on I}$ max. 20 N	T_a -25..+70°C		
-----------------------------------	------------------------------------	---------------------------------------	-----------------------	----------------------------	---------------	--------------------------------	----------------------------	--	--

TRACON			
IP 42	+	IP42	IP65
NYGBL21	NYGBL21T		NYGD-1GR 1 × NO
NYGBL31Z	NYGBL31ZT		1 × NO
NYGBL51S	NYGBL51ST		1 × NO
NYGBL61K	NYGBL61KT		1 × NO
NYGBL42P	NYGBL42PT		1 × NC
			page K/32

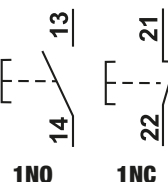
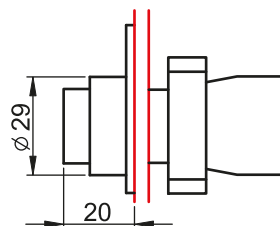

RELEVANT STANDARD
EN 60947-1

RELEVANT STANDARD
EN 60947-5-1

Gumiburkolatos nyomógombok (fémalpra szerelt)



I_e (AC 1, 230 V) 6 A	I_e (AC 15, 230 V) 3 A	I_e (DC 13, 250 V) 0,27 A	U_i 660 V	$[mm^2]$ 0,5-2,5	$\times 10^6$	$F_{on I}$ max. 20 N	T_a -25..+70°C		
-----------------------------------	------------------------------------	---------------------------------------	-----------------------	----------------------------	---------------	--------------------------------	----------------------------	--	--

TRACON			
IP 55	+	IP42	IP65
NYGBP21	NYGBP21T		NYGD-1GR 1 × NO
NYGBP31Z	NYGBP31ZT		1 × NO
NYGBP51S	NYGBP51ST		1 × NO
NYGBP61K	NYGBP61KT		1 × NO
NYGBP42P	NYGBP42PT		1 × NC
			page K/32

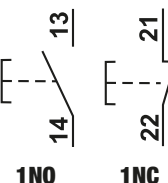
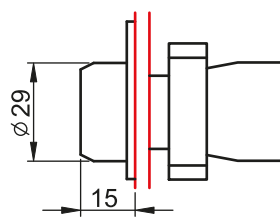

RELEVANT STANDARD
EN 60947-1

RELEVANT STANDARD
EN 60947-5-1

Jelölt nyomógombok (fémalpra szerelt)

I_e (AC 1, 230 V) 6 A	I_e (AC 15, 230 V) 3 A	I_e (DC 13, 250 V) 0,27 A	U_i 660 V	[mm²] 0,5-2,5	x10⁶	F_{on} I max. 20 N	T_a -25..+70°C	22 mm	Piktogramok	K/O
--	---	--	--------------------------------------	---	------------------------	---	---	--------------	--------------------	------------

TRACON		IP 42	IP 65	NC	NO
NYGBA3351	NYGBA3351T	→	→	1 × NO	
NYGBA3341	NYGBA3341T	→	→	1 × NO	
NYGBA3311Z	NYGBA3311ZT	—	—	1 × NO	
NYGBA4222P	NYGBA4222PT	0	0	1 × NC	
NYGBA4322P*	NYGBA4322PT*	0	0	1 × NC	

page K/32

* Kiálló típusváltozat

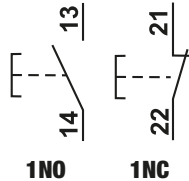
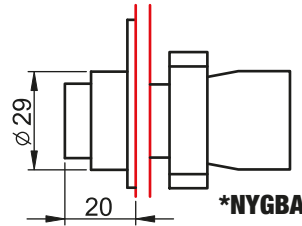
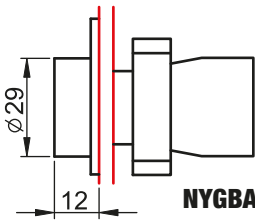

Világító nyomógombok (fémalpra szerelt)

TRACON		IP 42	IP 65	NC	NO	U _m	Ba9s
	NYGBW33Z	NYGBW33ZT	NYGD-1GR	1 × NO	max. 400 V	NYGI230*	
	NYGBW33S	NYGBW33ST		1 × NO	max. 400 V	NYGI230*	
	NYGBW33K	NYGBW33KT		1 × NO	max. 400 V	NYGI230*	
	NYGBW33P	NYGBW33PT		1 × NC	max. 400 V	NYGI230*	
	NYGBW3371Z	NYGBW3371ZT	NYGD-1GR	1 × NO	230-240 V	NYGI130**	
	NYGBW3571S	NYGBW3571ST		1 × NO	230-240 V	NYGI130**	
	NYGBW3471P	NYGBW3471PT		1 × NC	230-240 V	NYGI130**	
	NYGBW3341Z	-	-	1 × NO	230-240 V	NYGI6**	
	NYGBW3541S	-	-	1 × NO	230-240 V	NYGI6**	
	NYGBW3441P	-	-	1 × NC	230-240 V	NYGI6**	
	NYGBW3351Z	-	-	1 × NO	400 V	NYGI6**	
	NYGBW3551S	-	-	1 × NO	400 V	NYGI6**	
NYGBW3451P	-	-	1 × NC	400 V	NYGI6**		

* Az alkalmazni kívánt izzót az üzemi feszültség függvényében kell megválasztani.

A jelzőlámpákat izzó nélkül szállítjuk.

** Az előtéttel szerelt jelzőlámpákban használt izzó működtető feszültsége 130 V, a transzformátorral szerelt kivitelek esetén 6 V.

 1NO 1NC	 Előtét nélkül		 Előtéttel		 Transzformátorral	

Gombafejű nyomógombok (fémalpra szerelt)

I_e (AC 1, 230 V) 6 A	I_e (AC 15, 230 V) 3 A	I_e (DC 13, 230 V) 0,27 A	U_i 660 V	$[mm^2]$ 0,5-2,5	$\times 10^6$ $\times 10^6$	F_{on} max. 20 N	T_a -25..+70°C			K/O
-----------------------------------	------------------------------------	---------------------------------------	-----------------------	----------------------------	--	--------------------------------	----------------------------	--	--	------------

TRACON

IP 42

NYGBC21	NYGBC21T	-		NYGD-1GR	1 x NO	
NYGBC31Z	NYGBC31ZT	-		page K/32	1 x NO	40 mm
NYGBC51S	NYGBC51ST	-			1 x NO	
NYGBC61K	NYGBC61KT	-			1 x NO	
NYGBC42P	NYGBC42PT	NYGBC42PTS		NYGD-1YE	1 x NC	
NYGBR42P	NYGBR42PT	NYGBR42PTS		page K/32	1 x NC	60 mm

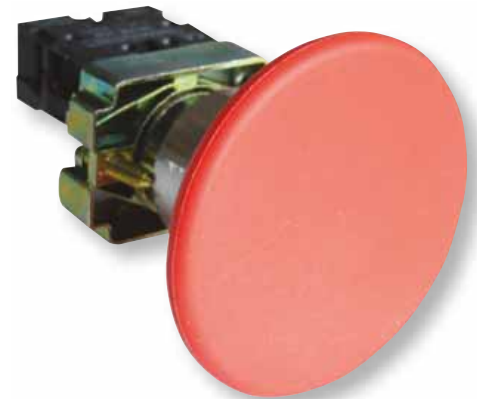
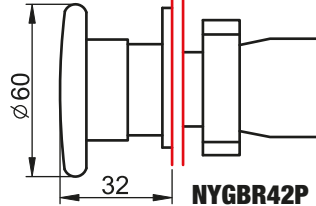
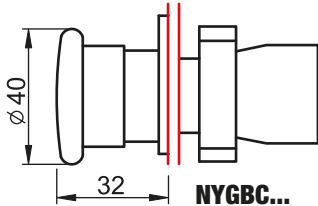
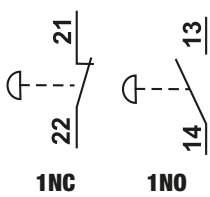

RELEVANT STANDARD
EN 60947-1

RELEVANT STANDARD
EN 60947-5-1

Reteszelt gombafejű nyomógombok (fémalpra szerelt)

I_e (AC 1, 230 V) 6 A	I_e (AC 15, 230 V) 3 A	I_e (DC 13, 230 V) 0,27 A	U_i 660 V	$[mm^2]$ 0,5-2,5	$\times 10^6$ $\times 10^6$	F_{on} max. 20 N	F_{off} max. 15 N	T_a -25..+70°C			K/O
-----------------------------------	------------------------------------	---------------------------------------	-----------------------	----------------------------	--	--------------------------------	---------------------------------	----------------------------	--	--	------------

TRACON

IP 42

NYG442P30	NYG442P30T	NYG442P30TS			1 x NC	30 mm	
NYG542P40	NYG542P40T	NYG542P40TS		NYGD-1GR	1 x NC	40 mm	
NYG642P60	NYG642P60T	NYG642P60TS		NYGD-1YE	1 x NC	60 mm	
NYGBS8445P	NYGBS8445PT	NYGBS8445PTS		page K/32	1 x NC+1 x NO	40 mm	
NYGBS142P	NYGBS142PT	NYGBS142PTS			1 x NC	40 mm	
NYGBS9445P	NYGBS9445PT	NYGBS9445PTS			1 x NC+1 x NO	40 mm	

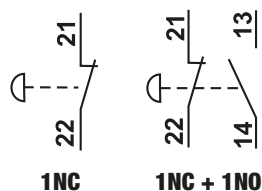
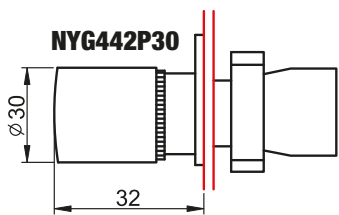

NYG642P60

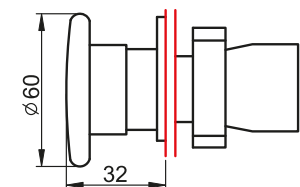

NYG542P40, NYGBS8445P

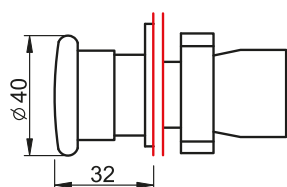

NYGBS142P, NYGBS9445P

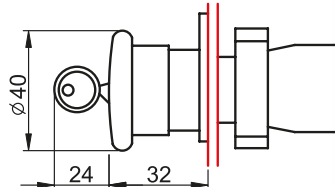

Kettős, be-ki nyomógombok (fémalapra szerelt)

I_e (AC 1, 230 V) 6 A	I_e (AC 15, 230 V) 3 A	I_e (DC 13, 250 V) 0,27 A	U_i 660 V	[mm ²] 0,5-2,5	$\times 10^6$	$F_{on\ I}$ max. 20 N	T_a -25..+70°C			
-----------------------------------	------------------------------------	---------------------------------------	-----------------------	--------------------------------------	---------------	--------------------------	---------------------	--	--	--

TRACON				
NYKK8325	NYKK8325T	I	0	NYGD-1GR 1 x NC+1 x NO
NYKK8425	NYKK8425T	I	0	page K/32 1 x NC+1 x NO

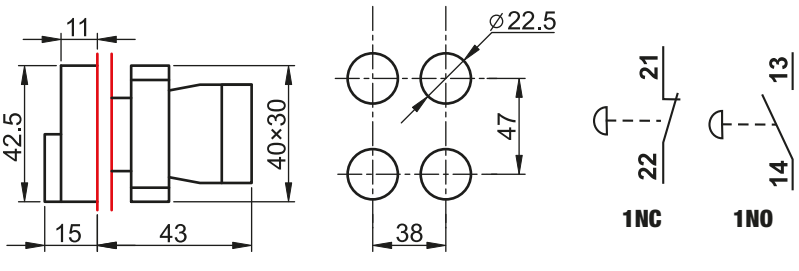

Kettős, be-ki nyomógombok jelzőfényel (fémalapra szerelt)

I_e (AC 1, 230 V) 6 A	I_e (AC 15, 230 V) 3 A	I_e (DC 13, 250 V) 0,27 A	U_i 660 V	[mm ²] 0,5-2,5	$\times 10^6$	$F_{on\ I}$ max. 20 N	T_a -25..+70°C			
-----------------------------------	------------------------------------	---------------------------------------	-----------------------	--------------------------------------	---------------	--------------------------	---------------------	--	--	--

TRACON			U_m	
	NYKK8365	I	0	1 x NC+1 x NO max. 400 V NYGI230*
	NYKK8465	I	0	1 x NC+1 x NO max. 400 V NYGI230*
	NYKK8375	I	0	1 x NC+1 x NO 240 V NYGI130**
	NYKK8475	I	0*	1 x NC+1 x NO 240 V NYGI130**

* Az alkalmazni kívánt izzót az üzemi feszültség függvényében kell megválasztani.
** Az előtétellel szerelt jelzőlámpákban használt izzó működtető feszültsége 130 V.

A jelzőlámpákat izzó nélkül szállítjuk.

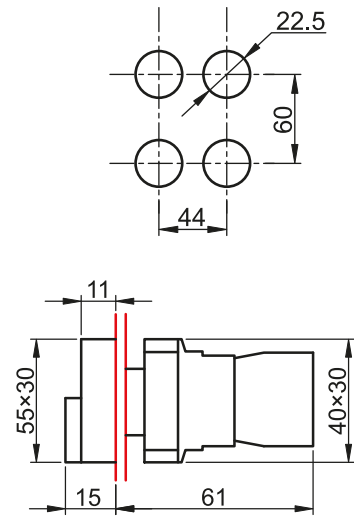
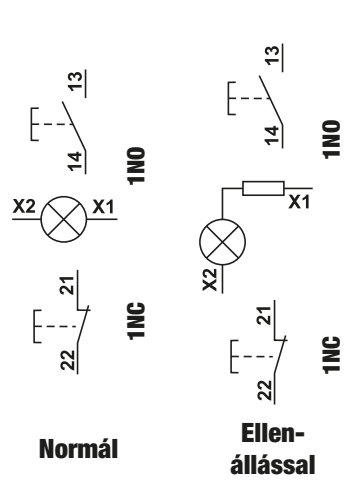

Jelzőlámpák (fémalapra szerelt)

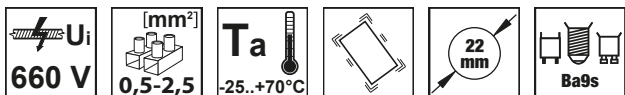

TRACON		IP 42	IP42	Um	IP65	Light Bulb Icon
	NYGBV61	NYGBV61T		max. 400 V	NYGD-1GR	NYGI230
	NYGBV64P	NYGBV64PT		max. 400 V		NYGI230
	NYGBV63Z	NYGBV63ZT		max. 400 V		NYGI230
	NYGBV65S	NYGBV65ST		max. 400 V		NYGI230
	NYGBV66K	NYGBV66KT		max. 400 V		NYGI230
	NYGBV73Z	NYGBV73ZT		230-240 V	page K/32	NYGI130*
	NYGBV74P	NYGBV74PT		230-240 V		NYGI130*
	NYGBV75S	NYGBV75ST		230-240 V		NYGI130*
	NYGBV43Z	NYGBV43ZT		230-240 V	NYGD-1GR	NYGI6*
	NYGBV44P	NYGBV44PT		230-240 V		NYGI6*
	NYGBV45S	NYGBV45ST		230-240 V		NYGI6*
	NYGBV53Z	NYGBV53ZT		400 V		NYGI6*
	NYGBV54P	NYGBV54PT		400 V		NYGI6*
	NYGBV55S	NYGBV55ST		400 V	page K/32	NYGI6*

A jelzőlámpákat izzó nélkül szállítjuk.

Az alkalmazni kívánt izzót az üzemi feszültség függvényében kell megválasztani.

* Az előtétellel szerelt jelzőlámpákban használt izzó működtető feszültsége 130 V, a transzformátorral szerelt kivitelek esetén 6 V.

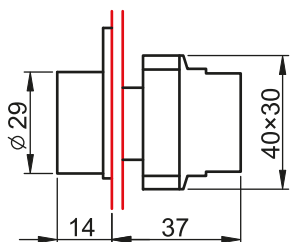

Normál

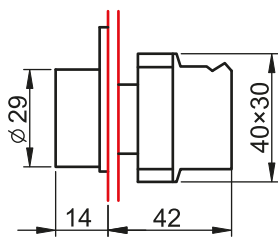

Ellenállással

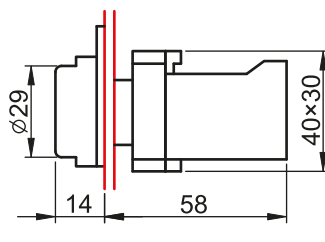
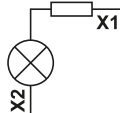

Transzformátorral

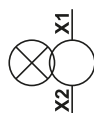

TÜV MEEI TEST DOCUMENTATION
V-15180

RELEVANT STANDARD
EN 62094



Kontaktorok

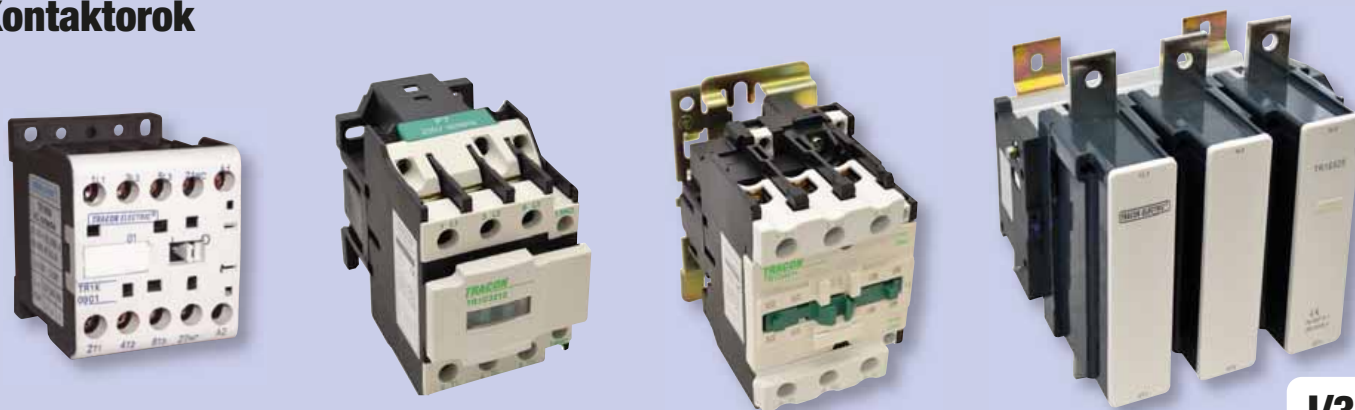

I/36

Karos kapcsolók (fémalapra szerelt)

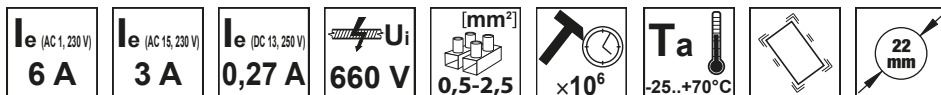

TRACON		IP65	NC NO	L
Normál	NYBD21KST	NYBD21KSTT	1 × NO	29 mm
	NYBJ21KLO	NYBJ21KLOT	1 × NO	39 mm
	KBD25ST	KBD25STT	1 × NC+1 × NO	29 mm
	KBJ25LO	KBJ25LOT	1 × NC+1 × NO	39 mm
	NYBD33KST	NYBD33KSTT	2 × NO	29 mm
	NYBJ33KLO	NYBJ33KLOT	2 × NO	39 mm
Rugó- visszatérítéses	NYBD41KST	NYBD41KSTT	1 × NO	29 mm
	NYBJ41KLO	NYBJ41KLOT	1 × NO	39 mm
	NYBD45KST	NYBD45KSTT	1 × NC+1 × NO	29 mm
	NYBJ45KLO	NYBJ45KLOT	1 × NC+1 × NO	39 mm
	NYBD53KST	NYBD53KSTT	2 × NO	29 mm
	NYBJ53KLO	NYBJ53KLOT	2 × NO	39 mm

NYGD-1GR

page
K/32

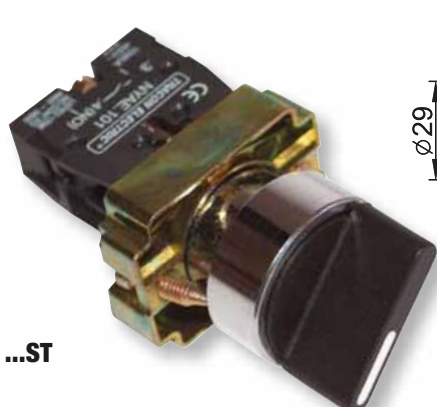

...ST

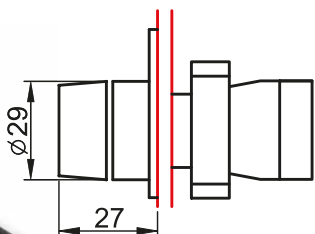

Kétállású normál

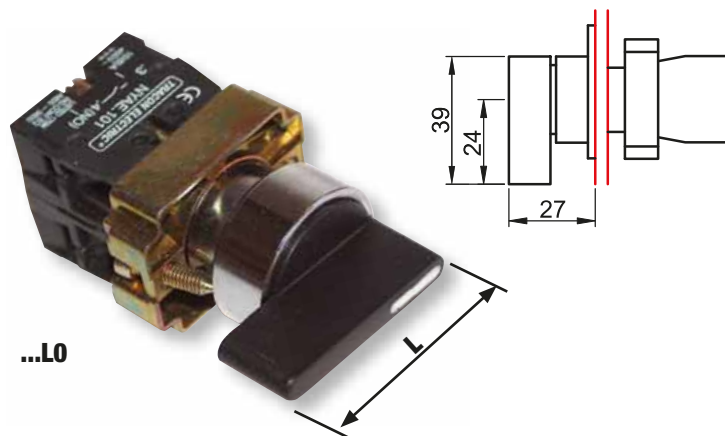
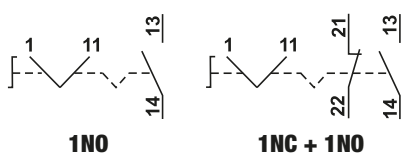

...LO

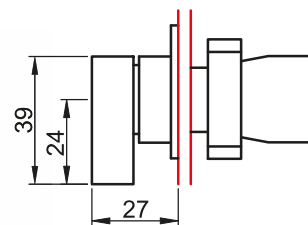

Kétállású rugóvisszatérítéses

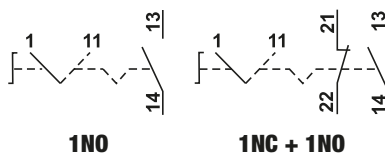

Háromállású rugóvisszatérítéses

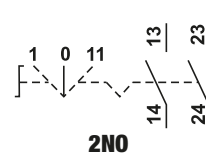

Világítókaros kapcsolók (fémalpra szerelt)



I_e (AC 1, 230 V) 6 A	I_e (AC 15, 230 V) 3 A	I_e (DC 13, 250 V) 0,27 A	U_i 660 V	[mm²] 0,5-2,5	×10⁶	T_a -25..+70°C	U_m max. 400 V	22 mm	Ba9s
--	---	--	--------------------------------------	---	------------------------	---	---	--------------	-------------

TRACON		IP 42	+	IP42	IP65	NC	NO	Ba9s
Normál	NYGBK2365Z	NYGBK2365ZT	1 2	1 2	NYGD-1GR	1 × NC+1 × NO	NYGLZ *	
	NYGBK2565S	NYGBK2565ST	1 2	1 2		1 × NC+1 × NO	NYGLS *	
	NYGBK2665K	NYGBK2665KT	1 2	1 2		1 × NC+1 × NO	NYGLK *	
	NYGBK2465P	NYGBK2465PT	1 2	1 2		1 × NC+1 × NO	NYGLP *	
	NYGBK3365Z	NYGBK3365ZT	1 0 2	1 0 2		1 × NC+1 × NO	NYGLZ *	
	NYGBK3565S	NYGBK3565ST	1 0 2	1 0 2		1 × NC+1 × NO	NYGLS *	
	NYGBK3665K	NYGBK3665KT	1 0 2	1 0 2		1 × NC+1 × NO	NYGLK *	
	NYGBK3465P	NYGBK3465PT	1 0 2	1 0 2		1 × NC+1 × NO	NYGLP *	
					page K/32			



* A jelzőlámpákat izzó nélkül szállítjuk.

RELEVANT STANDARD
EN 60947-1

RELEVANT STANDARD
EN 60947-5-1

Háromállású rugóvisszatérítéses

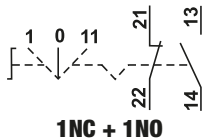

Kétállású normál

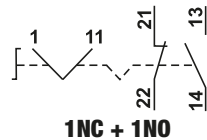

Háromállású normál

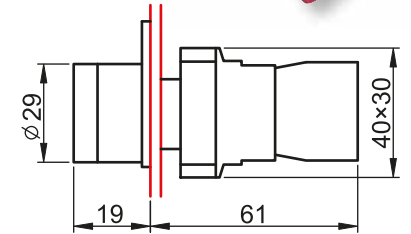
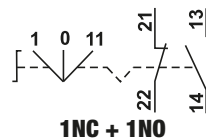

Kulcsos kapcsolók (fémalpra szerelt)



I_e (AC 1, 230 V) 6 A	I_e (AC 15, 230 V) 3 A	I_e (DC 13, 250 V) 0,27 A	U_i 660 V	[mm²] 0,5-2,5	×10⁶	T_a -25..+70°C	22 mm
--	---	--	--------------------------------------	---	------------------------	---	--------------

TRACON		IP 42	+	IP42	IP65	NC	NO
Normál	NYBG21KK	NYBG21KKT	1 2	1 2	NYGD-1GR	1 × NO	1 2
	NYBG41KK	NYBG41KKT	1 2	1 2		1 × NO	1 2
	NYBG25KK	NYBG25KKT	1 2	1 2		1 × NC+1 × NO	1 2
	NYBG53KK	NYBG53KKT	1 2	1 2		2 × NO	1 2
Rugóvisszatérítéses	NYBG61KK	NYBG61KKT	1 2	1 2	page K/32	1 × NO	1 2
	NYBG65KK	NYBG65KKT	1 2	1 2		1 × NC+1 × NO	1 2
	NYBG73KK	NYBG73KKT	1 2	1 2		2 × NO	1 2

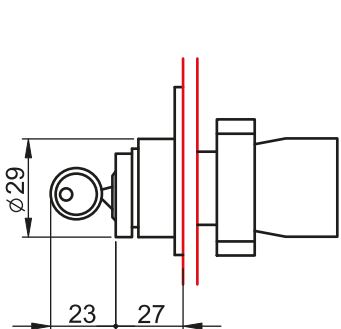

Kétállású normál

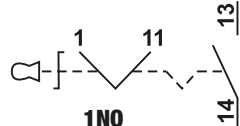

Kétállású normál

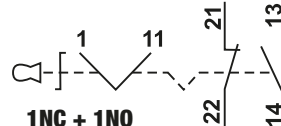

Háromállású normál

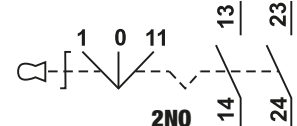

Kétállású rugóvisszatérítéses

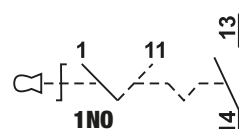

Kétállású rugóvisszatérítéses

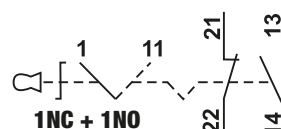

Háromállású rugóvisszatérítéses

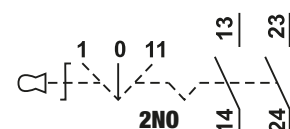

Normál jelzőizzók



TRACON	U _m		
NYGI6	6 V AC/DC	1,2 W	Ba9s
NYGI12	12 V AC/DC	2 W	Ba9s
NYGI24	24 V AC/DC	2 W	Ba9s
NYGI48	48 V AC/DC	2 W	Ba9s
NYGI130	130 V AC/DC	2,6 W	Ba9s
NYGI230	230 V AC	glimm	Ba9s

LED-es jelzőizzók (új kivitel)



TRACON	U _m		
NYGL-AC400B	400 V AC		Ba9s
NYGL-AC400G	400 V AC		Ba9s
NYGL-AC400R	400 V AC		Ba9s
NYGL-AC400W	400 V AC		Ba9s
NYGL-AC400Y	400 V AC		Ba9s
NYGL-ACDC230B	230 V AC/DC		Ba9s
NYGL-ACDC230G	230 V AC/DC		Ba9s
NYGL-ACDC230R	230 V AC/DC		Ba9s
NYGL-ACDC230W	230 V AC/DC		Ba9s
NYGL-ACDC230Y	230 V AC/DC		Ba9s
NYGL-ACDC24B	24 V AC/DC		Ba9s
NYGL-ACDC24G	24 V AC/DC		Ba9s
NYGL-ACDC24R	24 V AC/DC		Ba9s
NYGL-ACDC24W	24 V AC/DC		Ba9s
NYGL-ACDC24Y	24 V AC/DC		Ba9s

Érintkezőelemek



3 — 4 (NO)
NYAE101

1 — 2 (NC)
NYAE102

TRACON		
NYAE101	1 × NO	
NYAE102	1 × NC	

Az alapszerelvényre rögzíthető érintkezőelemek száma szükség esetén max. 4 darabra bővíthető.

Szűkítőgyűrűk



TRACON	
NYGR25/22	Szűkítőgyűrű, D=25 mm / d=22 mm; ABS (1 db)
NYGR30/22	Szűkítőgyűrű, D=30 mm-ről d=22 mm-re (1 pár)
NYGR38/22	Szűkítőgyűrű, D=38 mm-ről d=22 mm-re (1 pár)

Régebben készült elosztótáblák vezérlőkészülékeinek cseréje esetén, amelyek Ø38 mm-es furatba voltak szerelve, ún. redukáló gyűrűk segítségével lehet a készüléket a szerelőlapoz rögzíteni.



OLVASSA BE A KÓDOT!

- Nézze meg újdonságainkat
- Legyen naprakész

Kínálatunk gyorsan és folyamatosan fejlődik!
Katalógusunk a 2021. áprilisi állapotot tükrözi.

Naprakész információért
látogasson el honlapunkra!

Tokozatok

TRACON		W (mm)	H (mm)	x (mm)		IP..
TK/T1+F2/		68	64	44	2 × MG-20	IP 44
TK/T2+F2/		68	80	44	2 × MG-20	IP 44
TK/T1+F2S/		68	64	44	2 × MG-20	IP 44
TK/T2+F2S/		68	80	44	2 × MG-20	IP 44

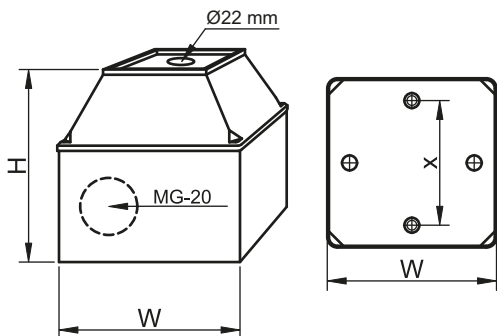

TÜV MEEI TEST DOCUMENTATION
V-15180

RELEVANT STANDARD
EN 60529

TRACON
ELECTRIC®

TDB
CSATLAKOZÓ
DOBOZOK

G/27

Relés biztonsági kapcsolók

Piktogramok

Az SSTM típusú készülékek alkalmasak különböző egy- vagy háromfázisú szerszámgépek, illetve villamos berendezések biztonságos kapcsolására. Feszültségkimaradás esetén a kapcsoló automatikusan leoldja a csatlakoztatott berendezést a hálózatról. Az újraindítás csak a felhasználó által, a zöld "I" gomb ismételt megnyomásával lehetséges, megelőzve ezzel a gép véletlen, nem kívánt újbóli elindulását.

Figyelem! A készüléket a rajta lévő bekötési ábra szerint csatlakoztassuk!



SSTM-01..



TRACON SSTM-01

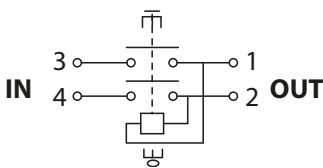

TRACON SSTM-015

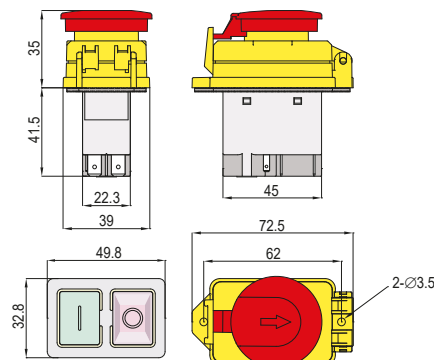
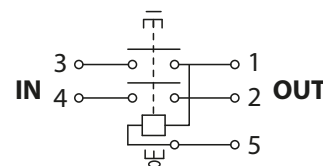

230 V AC
I_e (AC 3, 230 V) 12 A
6,3×0,8 mm
×10⁴

SSTM-02..



TRACON SSTM-02

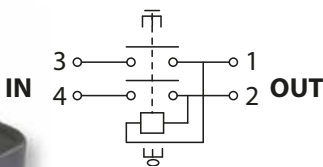

TRACON SSTM-025

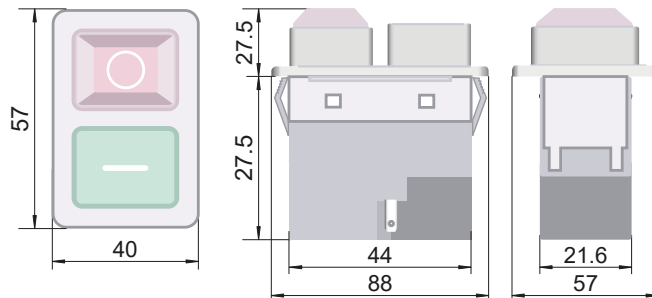
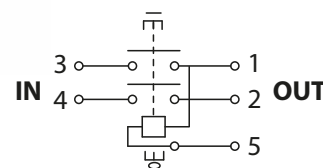

230 V AC
I_e (AC 3, 230 V) 12 A
6,3×0,8 mm
5×10⁴

SSTM-03..



TRACON SSTM-03

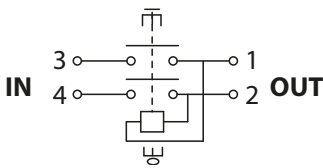

TRACON SSTM-035

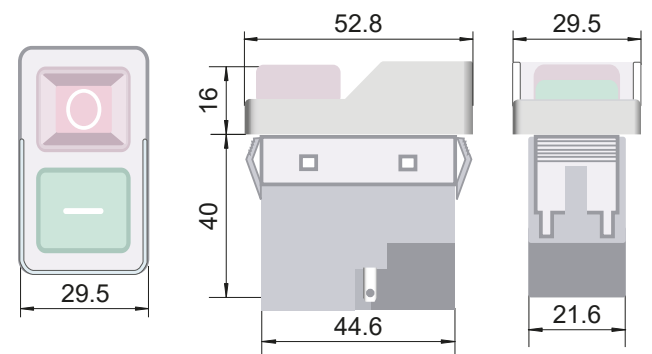
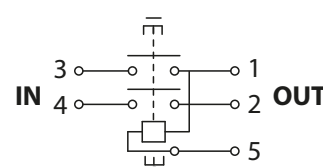

230 V AC
I_e (AC 3, 230 V) 12 A
6,3×0,8 mm
5×10⁴

SSTM-04..

230 V AC

**I_e (AC 3, 230 V)
12 A**

6,3×0,8 mm

5×10⁴

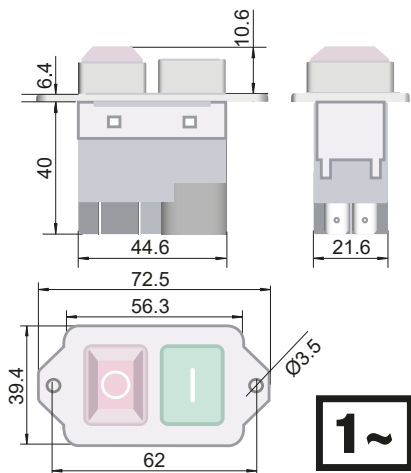

TRACON SSTM-04

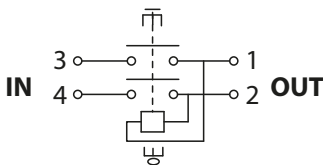

TRACON SSTM-045

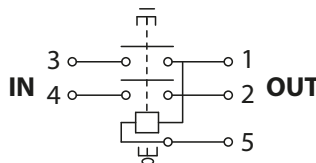

SSTM-31..

400 V AC

**I_e (AC 3, 400 V)
8 A**

6,3×0,8 mm

×10⁴

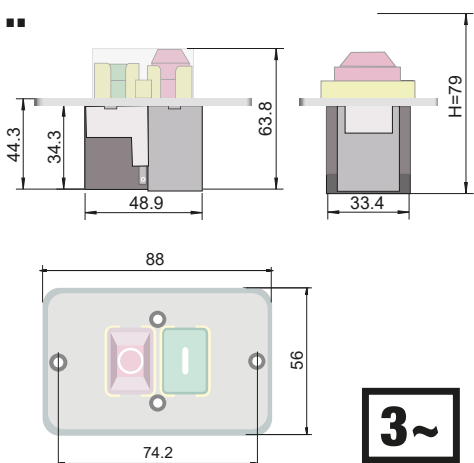

TRACON SSTM-316

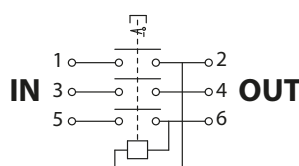

TRACON SSTM-317

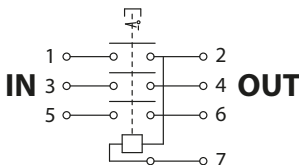

SSTM-32..

400 V AC

**I_e (AC 3, 400 V)
8 A**

6,3×0,8 mm

5×10⁴

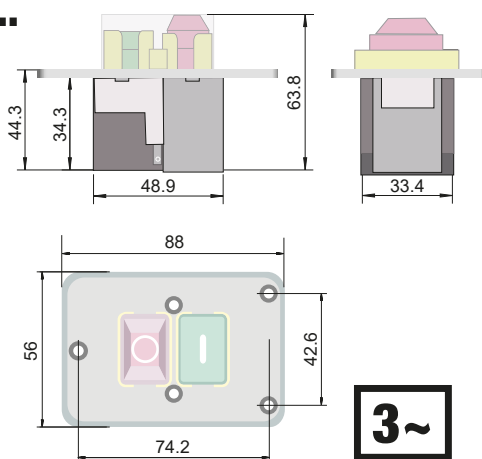

TRACON SSTM-326

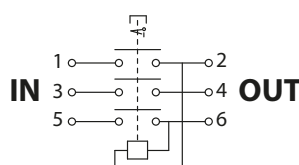

TRACON SSTM-327

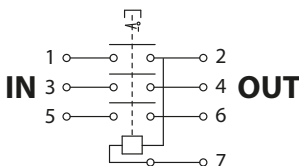

Elektronikai dobozok



M/15

SSTM-BOX

A következő típusokhoz alkalmazható:

- SSTM-02, -025**
- SSTM-316, -317**
- SSTM-326, -327**

113×77×60 mm



IP 42



TRACON SSTM-BOX





TES készülékkapcsolók

U_m max. 250 V	I_e (AC 1, 230 V) 16 A	I_e (AC 15, 230 V) 6 A	I_e (DC 13, 250 V) 0,27 A	U_i 660 V	U_{imp} 6 kV	[mm²] 0,5-2,5	5×10⁴	[h] 15.000	% rH max. 95	T_a -20..+55°C	IP 42	10 A gG
------------------------------------	---	---	--	--------------------------------------	---------------------------------------	---	-------------------------	-----------------------------	-------------------------------	---	--------------	----------------

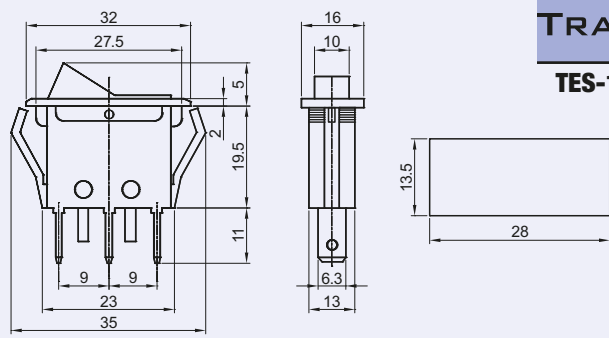
A készülékkapcsolók vezérléstechnikai eszközök, valamint különféle háztartási és egyéb villamos készülékekbe való beépítésre alkalmasak. A világító készülékkapcsolókat olyan helyekre ajánljuk, ahol fontos a készülék bekapcsolt állapotának jelzése. A kapcsoló a kivágási furatba egyszerű mozdulattal bepattintható, szabványos csatlakozókapcsaira 4,8×0,8 mm ill. 6,3×0,8 mm-es lapos rátolható csatlakozóhüvelyyel ellátott vezetékeket lehet csatlakoztatni.

BE-KI kapcsoló





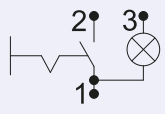

TRACON			
TES-11	6,3 × 0,8 mm		3

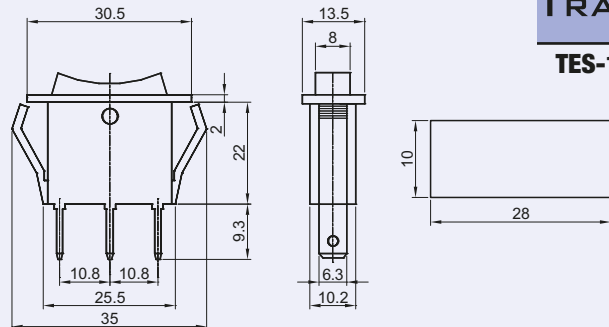

Közép 0 állású kapcsoló





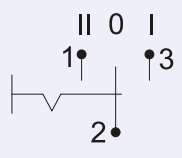

TRACON			
TES-12	6,3 × 0,8 mm	I-0-II	-

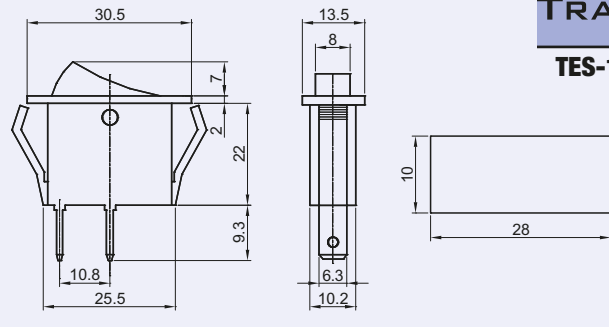

BE-KI kapcsoló







TRACON			
TES-13	6,3 × 0,8 mm	0-I	-

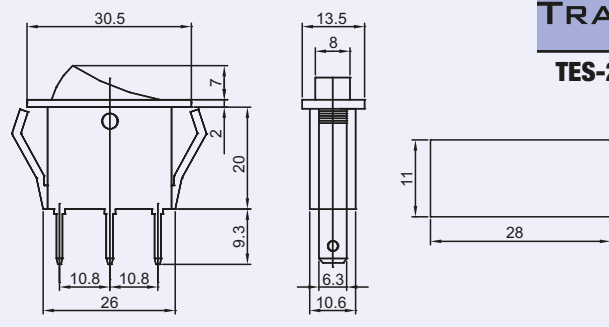

BE-KI kapcsoló

TRACON			
TES-21	6,3 × 0,8 mm		✓



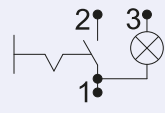

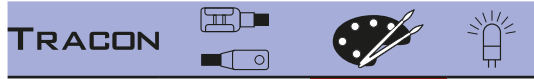
TES-22 4,8 × 0,8 mm

0-1

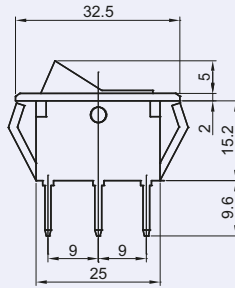
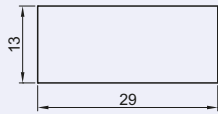
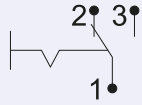

Váltókapcsoló

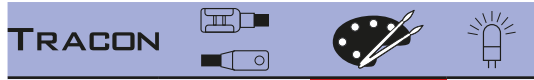

TES-33 4,8 × 0,8 mm

0-1

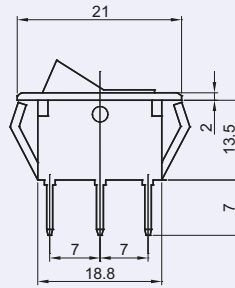
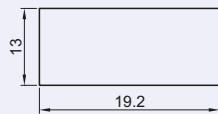
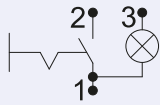

BE-KI kapcsoló

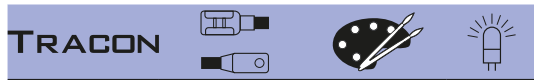
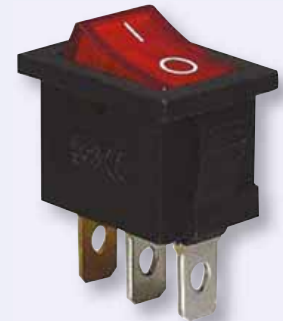

TES-34 4,8 × 0,8 mm

0-1

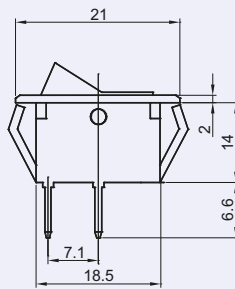
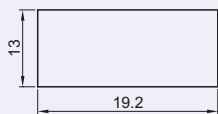
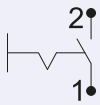

BE-KI kapcsoló



RELEVANT STANDARD
EN 61058-1

RELEVANT STANDARD
EN 61058-2-5

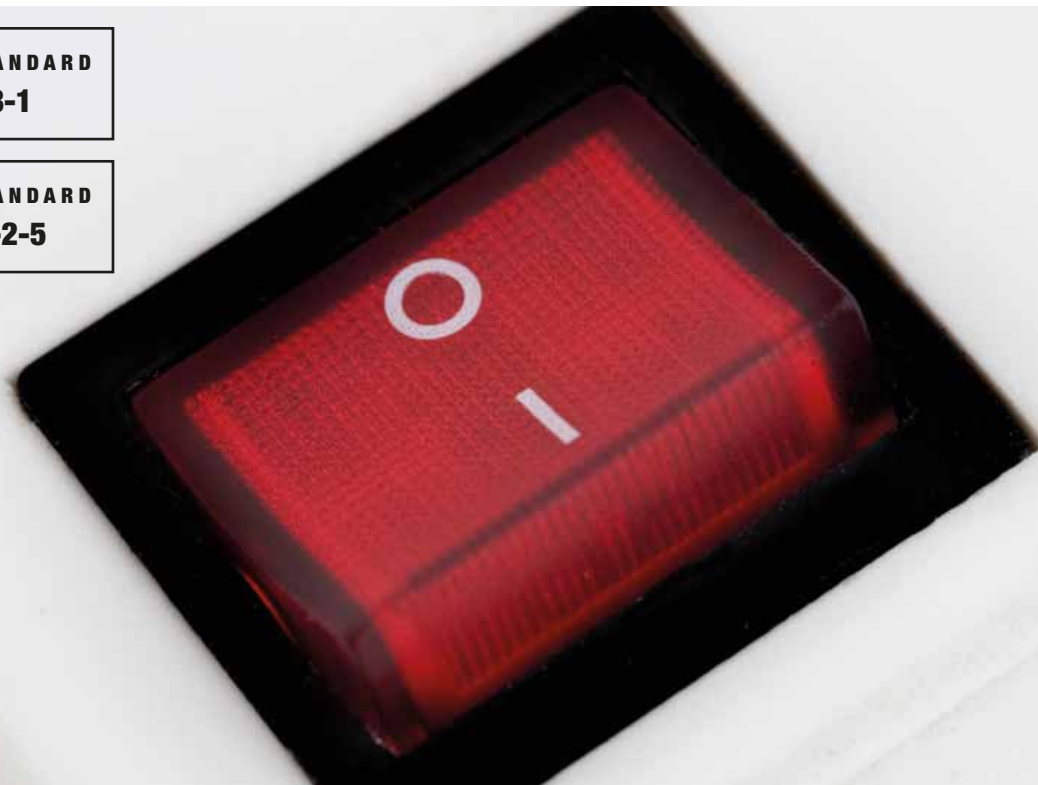

Kétpólusú BE-KI kapcsoló

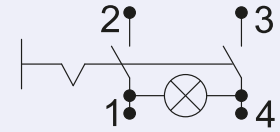
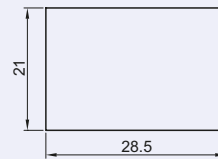
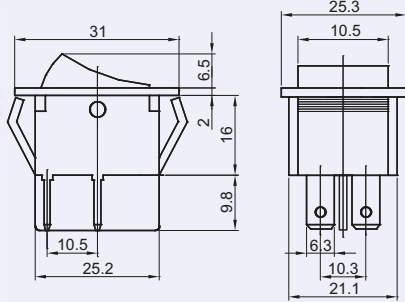

TRACON



TES-41

6,3 × 0,8 mm



Kétpólusú BE-KI kapcsoló

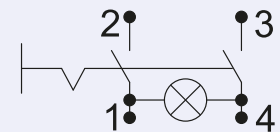
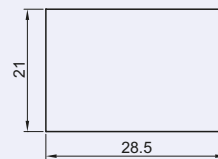
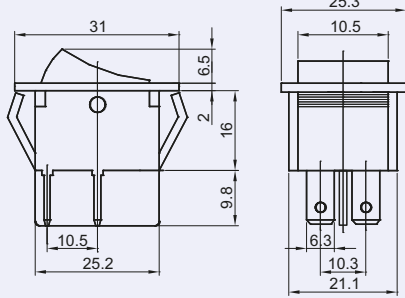

TRACON



TES-42

6,3 × 0,8 mm



BE-KI kapcsoló

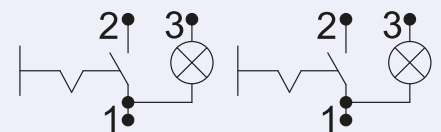
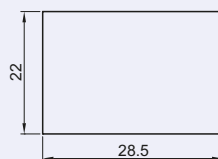
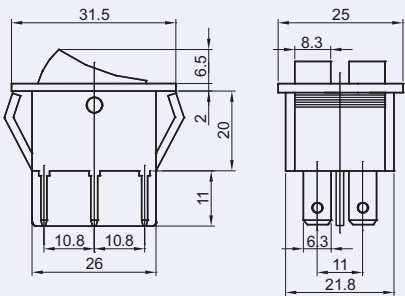

TRACON



TES-43

6,3 × 0,8 mm

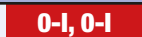

Kétpólusú BE-KI kapcsoló

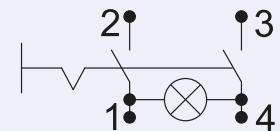
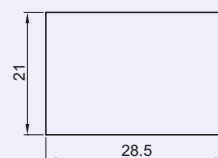
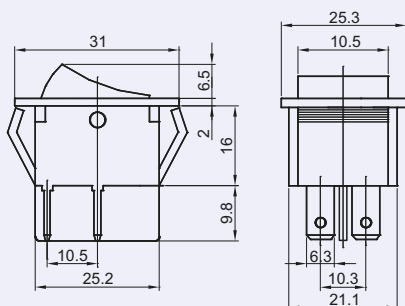

TRACON



TES-44

6,3 × 0,8 mm



Kétpólusú BE-KI kapcsoló

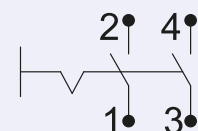
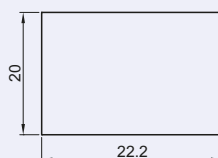
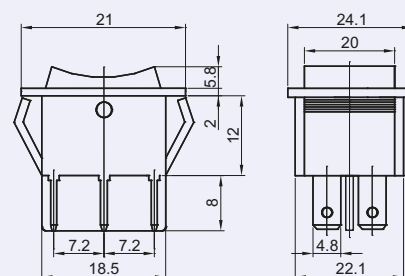

TRACON



TES-51

4,8 × 0,8 mm

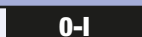

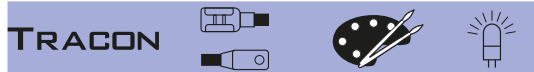

TES-52	6,3 × 0,8 mm	I-0-II	-
TES-52-2	6,3 × 0,8 mm	I-0-II	-

Kétpólusú választókapcsoló



TES-52

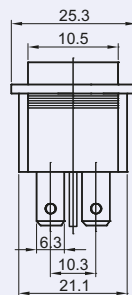
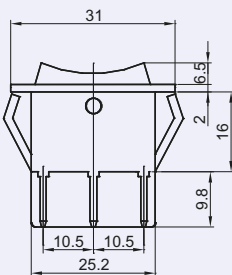
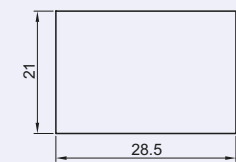
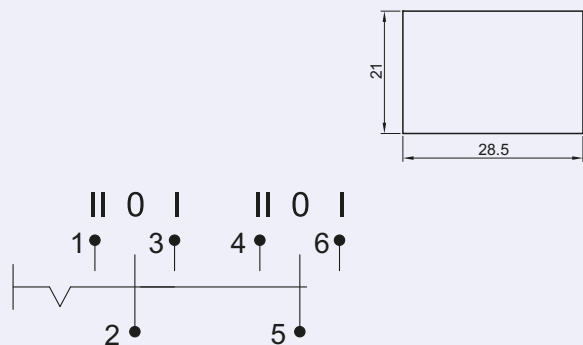

Kétpólusú választókapcsoló (rugóvisszatértéses)



TES-52-2

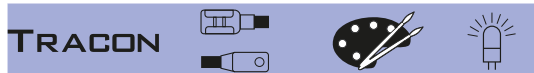
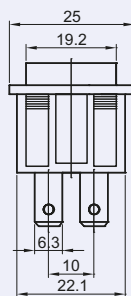
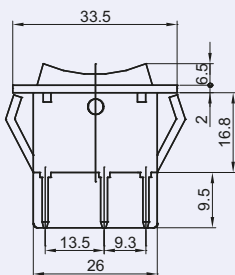
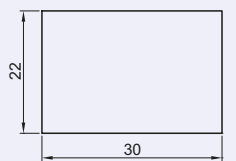

TES-53	6,3 × 0,8 mm	0-1	-
---------------	--------------	------------	---

Kétpólusú BE-KI kapcsoló

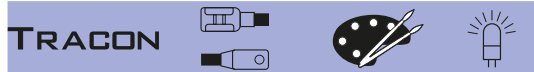
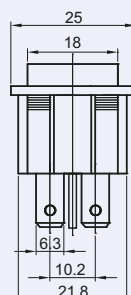
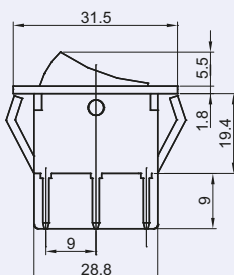
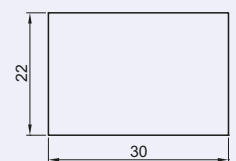
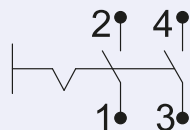

TES-53-1	6,3 × 0,8 mm	0-1	-
-----------------	--------------	------------	---

Kétpólusú BE-KI kapcsoló (rugó visszatértéses)

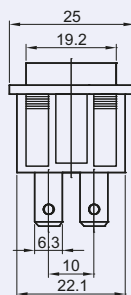
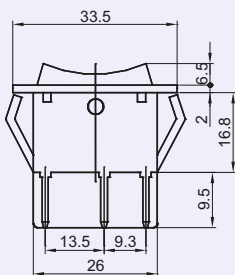
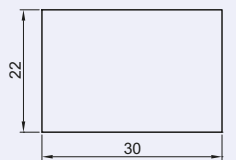
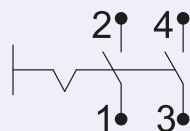

TRACON

TES-GB	TES-GB1
---------------	----------------

A következő típusokhoz alkalmazható:

TES-42	TES-33
TES-43	TES-34
TES-52	
TES-53	

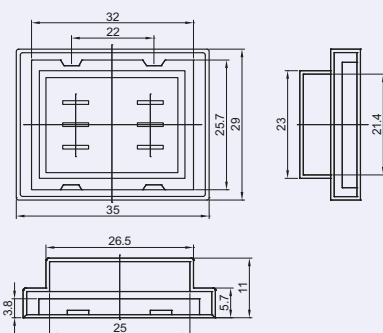

PVC membrán



TES-GB



TES-GB1

TVTR Egyfázisú elválasztótranszformátorok

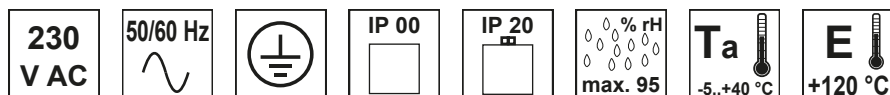

TRACON	P _n	U _{pr}	U _{sec}	P _{sec} *	I _{sec}
TVTR-50-A	50 VA	230 V	3-6-12-18-24 V	6,25-12,5-25-37,5-50 VA	2,08 A
TVTR-50-B		230 V	6-12-18-24 V	12,5-25-37,5-50 VA	2,08 A
TVTR-50-C		230 V	12-24-42 V	14,2-28,5-50 VA	1,19 A
TVTR-50-D		230 V	24-42-110 V	10-19-50 VA	0,45 A
TVTR-50-F		230 V	24-230 V	5,2-50 VA	0,21 A
TVTR-100-A		100 VA	230 V	3-6-12-18-24 V	12,5-25-50-75-100 VA
TVTR-100-B	230 V		6-12-18-24 V	25-50-75-100 VA	4,16 A
TVTR-100-C	230 V		12-24-42 V	28,5-57,1-100 VA	2,38 A
TVTR-100-D	230 V		24-42-110 V	21,8-38,1-100 VA	0,90 A
TVTR-100-F	230 V		24-230 V	10,4-100 VA	0,43 A
TVTR-150-B	150 VA		230 V	6-12-18-24 V	37,5-75-112,5-150 VA
TVTR-150-C		230 V	12-24-42 V	42,8-85,7-150 VA	3,57 A
TVTR-150-D		230 V	24-42-110 V	32,7-57,2-150 VA	1,36 A
TVTR-150-E		230 V	42-110-230 V	27,3-71,7-150 VA	0,65 A
TVTR-150-F		230 V	24-230 V	15,6-150 VA	0,65 A
TVTR-200-B		200 VA	230 V	6-12-18-24 V	50-100-150-200 VA
TVTR-200-C	230 V		12-24-42 V	57,1-114,2-200 VA	4,76 A
TVTR-200-D	230 V		24-42-110 V	43,6-76,3-200 VA	1,81 A
TVTR-200-E	230 V		42-110-230 V	36,5-95,6-200 VA	0,86 A
TVTR-200-F	230 V		24-230 V	20,8-200 VA	0,86 A

* a szekunder feszültség függvényében a megadott névleges teljesítményt a legnagyobb értékű feszültségen biztosítják.



Olyan kivitelű elválasztótranszformátorok, amelyekben a primer tekercsek alapszigeteléssel vannak elválasztva a szekunder tekercstől. Felhasználhatók kisfeszültségű erőátviteli, működtető, jelző, vezérlő és egyéb áramkörökben pl. az **MSZ HD 60364-4-41** szabvány szerinti **üzemi törpefeszültség (FELV)** előállítására, vagy egyszerű elválasztással a villamos elválasztás védelmi mód kialakítására egyetlen szekunder oldali fogyasztóval.

Egyfázisú kivitelben készülnek, nyolcféle szekunderfeszültség értékkel (U_{sec}=3-6-12-18-24-42-110-230 V).

Kielégítik az **MSZ EN 60742** és az **MSZ EN 61558** szabványok követelményeit. Védettség szempontjából nyitott (IP 00), beépítésre szánt kivitelűek, bekötésükre IP 20 védettségi fokozatú csavaros csatlakozókapcsok szolgálnak.

Típusjelzőjük 50 – 630 VA között, kivitelől függően változik. A szekunder tekercs megcsapolással készül és a legnagyobb szekunder feszültségnél biztosítja a névleges teljesítményt, ezért a megcsapolásoknál a feszültség csökkenésével arányos teljesítményt szolgáltat (lásd a táblázatban).

RELEVANT STANDARD
EN 61558-1

RELEVANT STANDARD
EN 61558-2-1



OLVASSA BE A KÓDOT!

- Nézze meg újdonságainkat
- Legyen naprakész

Kínálatunk gyorsan és folyamatosan fejlődik!
Katalógusunk a 2021. áprilisi állapotot tükrözi.
Naprakész információért látogasson el honlapunkra!

TRACON	P_n	U_{pr}	U_{sec}	P_{sec} *	I_{sec}	
TVTR-250-B	250 VA	230 V	6-12-18-24 V	62,5-125-187,5-250 VA	10,41 A	
TVTR-250-C		230 V	12-24-42 V	71,4-142,8-250 VA	5,95 A	
TVTR-250-D		230 V	24-42-110 V	54,5-95,4-250 VA	2,27 A	
TVTR-250-E		230 V	42-110-230 V	45,6-119,5-250 VA	1,08 A	
TVTR-250-F		230 V	24-230 V	26-250 VA	1,08 A	
TVTR-300-B		300 VA	230 V	6-12-18-24 V	75-150-225-300 VA	12,50 A
TVTR-300-C	230 V		12-24-42 V	85,7-171,4-300 VA	7,14 A	
TVTR-300-D	230 V		24-42-110 V	65,4-114,5-300 VA	2,72 A	
TVTR-300-E	230 V		42-110-230 V	54,7-143,4-300 VA	1,30 A	
TVTR-300-F	230 V		24-230 V	31,3-300 VA	1,30 A	
TVTR-400-B	400 VA		230 V	6-12-18-24 V	100-200-300-400 VA	16,66 A
TVTR-400-C		230 V	12-24-42 V	114,2-228,5-400 VA	9,52 A	
TVTR-400-D		230 V	24-42-110 V	87,2-152,7-400 VA	3,63 A	
TVTR-400-E		230 V	42-110-230 V	73-191,3-400 VA	1,73 A	
TVTR-400-F		230 V	24-230 V	41,7-400 VA	1,73 A	
TVTR-500-C		500 VA	230 V	12-24-42 V	142,8-285,7-500 VA	11,90 A
TVTR-500-D	230 V		24-42-110 V	109-190,9-500 VA	4,54 A	
TVTR-500-E	230 V		42-110-230 V	91,3-239,1-500 VA	2,17 A	
TVTR-500-F	230 V		24-230 V	52,1-500 VA	2,17 A	
TVTR-630-C	630 VA		230 V	12-24-42 V	180-360-630 VA	15 A
TVTR-630-D			230 V	24-42-110 V	137,4-240,5-630 VA	5,72 A
TVTR-630-E		230 V	42-110-230 V	115-301,3-630 VA	5,73 A	
TVTR-630-F		230 V	24-230 V	65,7-630 VA	2,73 A	

* a szekunder feszültség függvényében a megadott névleges teljesítményt a legnagyobb értékű feszültségen biztosítják.

TRACON	A (mm)	B (mm)	C (mm)	D (mm)	E (mm)	F (mm)	G (mm)	H (mm)	I (mm)	
TVTR-50	75	80	77	50	56	10	5,5	28	4	1,2 kg
TVTR-100	85	90	85	59	64	10	5,5	40	5	1,9 kg
TVTR-150	98	90	95	65	84	12	6	40	5	2,6 kg
TVTR-200	98	100	95	74	84	12	6	40	5	3,1 kg
TVTR-250	98	110	95	84	84	12	6	40	5	3,6 kg
TVTR-300	110	110	103	82	90	12	6	-	-	4,6 kg
TVTR-400	123	112	110	84	90	14	7	50	5	5,3 kg
TVTR-500	122	120	107	98	90	14	7	50	5	6,3 kg
TVTR-630	154	115	135	87	122	22	8	50	5	7,2 kg

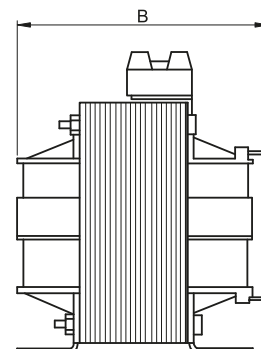
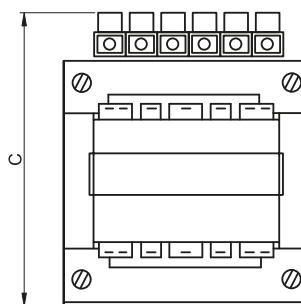
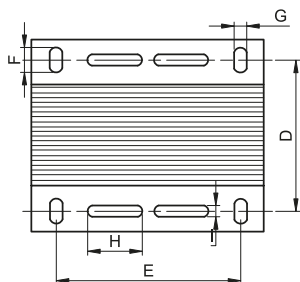
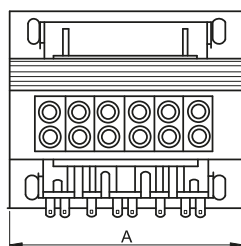

OLVASSA BE A KÓDOT!

- Nézze meg újdonságainkat
- Legyen naprakész

Kínálatunk gyorsan és folyamatosan fejlődik!
Katalógusunk a 2021. áprilisi állapotot tükrözi.
Naprakész információért
látogasson el honlapunkra!

TVTRB Egyfázisú szigetelőtranszformátorok

TRACON	P _n	U _{pr}	U _{sec}	P _{sec} *	I _{sec}
TVTRB-60-A	60 VA	230-400 V	6-12-24 V	15-30-60 VA	2,5 A
TVTRB-60-F		230-400 V	24-230 V	6,2-60 VA	0,26 A
TVTRB-60-0		230 V	42 V	60 VA	1,43 A
TVTRB-100-A	100 VA	230-400 V	6-12-24 V	25-50-100 VA	4,17 A
TVTRB-100-F		230-400 V	24-230 V	10,4-100 VA	0,43 A
TVTRB-100-0		230 V	42 V	100 VA	2,38 A

* a szekunder feszültség függvényében a megadott névleges teljesítményt a legnagyobb értékű feszültségen biztosítják.

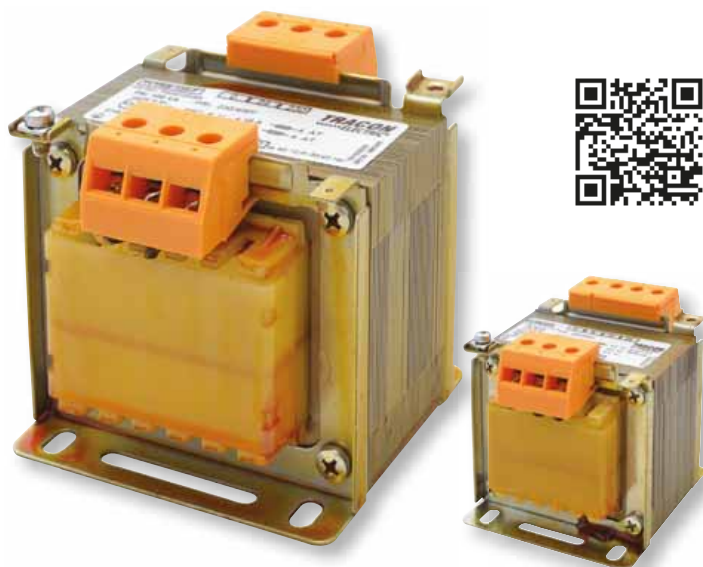

A termékek felhasználhatók kisfeszültségű erőátviteli, működtető, jelző, vezérlő és egyéb áramkörökben szigetelő elválasztásra, az **MSZ HD 60364-4-41** szabvány szerinti **érintésvédelmi törpefeszültség (SELV)** előállítására.

A primer és szekunder tekercsek között védőelválasztás van, ezek közül a biztonsági szigetelőtranszformátorok szekunder oldalon 50 V alatti u.n. biztonsági törpefeszültséget szolgáltatnak. Az 50 V-nál magasabb szekunderfeszültségű változatok az ún. szigetelő transzformátorok.

Valamennyi transzformátorunk kielégíti az **MSZ EN 60742** és az **MSZ EN 61558** szabványok követelményeit. Védettség szempontjából nyitott (IP 00), beépítésre szánt kivitelűek, bekötésükre csavaros csatlakozókapcsok szolgálnak.

Típusteljesítményük 60 – 600 VA között, kivitelől függően változik, a több szekunderfeszültséget szolgáltató transzformátorok szekunder tekercsei megcsapolással készülnek és a legnagyobb szekunder feszültségnél biztosítják a névleges teljesítményt.

A megcsapolásoknál a feszültség csökkenésével arányos teljesítményt szolgáltatnak (lásd a táblázatban).

RELEVANT STANDARD
EN 61558-1

RELEVANT STANDARD
EN 61558-2-4

Kisfeszültségű áramváltók



L/26-L/29

TRACON	P_n	U_{pr}	U_{sec}	P_{sec} *	I_{sec}
TVTRB-160-B	160 VA	230-400 V	12-24 V	80-160 VA	6,67 A
TVTRB-160-F		230-400 V	24-230 V	16,7-160 VA	0,70 A
TVTRB-160-M		230 V	12 V	160 VA	13,34 A
TVTRB-250-B	250 VA	230-400 V	12-24 V	125-250 VA	10,42 A
TVTRB-250-F		230-400 V	24-230 V	26-250 VA	1,09 A
TVTRB-250-O		230 V	42 V	250 VA	5,95 A
TVTRB-400-B	400 VA	230-400 V	12-24 V	200-400 VA	16,67 A
TVTRB-400-F		230-400 V	24-230 V	41,74-400 VA	1,74 A
TVTRB-400-O		230 V	42 V	400 VA	9,52 A
TVTRB-400-R		400 V	24 V	400 VA	16,67 A
TVTRB-600-B	600 VA	230-400 V	12-24 V	300-600 VA	25 A
TVTRB-600-D		230-400 V	24-42 V	342,9-600 VA	14,29 A
TVTRB-600-F		230-400 V	24-230 V	62,6-600 VA	2,61 A
TVTRB-600-O		230 V	42 V	600 VA	14,29 A
TVTRB-600-R		400 V	24 V	600 VA	25 A

* a szekunder feszültség függvényében a megadott névleges teljesítményt a legnagyobb értékű feszültségen biztosítják.

TRACON	A (mm)	B (mm)	C (mm)	D (mm)	E (mm)	F (mm)	G (mm)	H (mm)	I (mm)	m
TVTRB-60	75	90	76	60	56	10	5	28	4	1,5 kg
TVTRB-100	84	89	84	54	64	10	5,5	40	5	2,0 kg
TVTRB-160	96	80	108	70	84	11	5,8	35	3,6	2,4 kg
TVTRB-250	98	98	95	65	84	12	6	40	5	2,7 kg
TVTRB-400	123	115	110	84	90	14	7	50	5	5,3 kg
TVTRB-600	155	135	135	98	122	22	8	50	5	7,7 kg

RELEVANT STANDARD
EN 61558-1

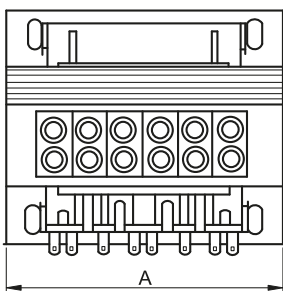

RELEVANT STANDARD
EN 61558-2-1

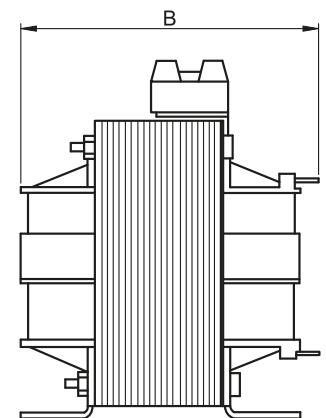
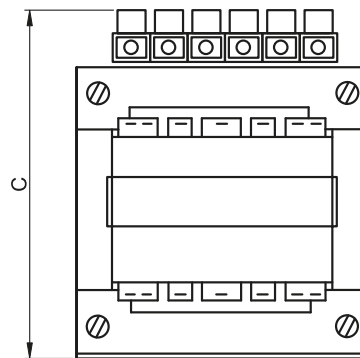
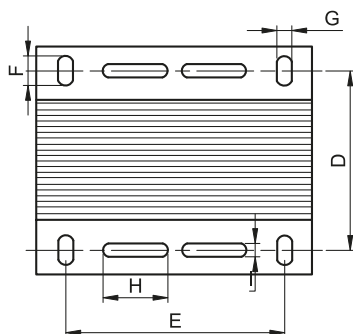

FLEAL

FŐÁRAMKÖRI LEÁGAZÓ KAPCSOK



A/30

Táblázat fejlécek piktogramjai

U_n Névleges feszültség (V)	I_n Névleges áram (A)	P_{max} Max. teljesítmény	P_s Indítási teljesítmény
Tömör, sodrott, hajlékony vezeték	Beköthető vezeték keresztmetszet	Méretek (LxWxH)	Tömeg
Elektromechanikus kijelzős mérőműszer	LCD kijelzős mérőműszer	Kijelző (digitek száma)	Tápellátás
Áttétel	Sönt	Elem típusa, adó	Elem típusa, vevő
Sínszélesség (áramváltó)	Vezeték átmérő (áramváltó)	Közvetlen mérőműszer	Áramváltós mérőműszer
Impulzus kimenet	Impulzus szélesség	Indítási áram	Bázisáram (max áram)
Kondenzátortelepek száma	Hőmérsékletmérés	Keretméret	Mérethatár
Pontossági osztály	Áramváltók száma	Kivágási méret (mm)	

Műszaki adatok piktogramjai

Rezgésállóság	Névleges termikus áram	Biztonsági tényező	Segédérintkezők
Hitelesített áramváltó	Relatív páratartalom	Lökőfeszültség-állóság	Védettség beépítve (homlokoldal felől)
Névleges dinamikus áram	Üzemóra számláló kijelzője	Cserélhető skálalap	Saját teljesítmény felvétel
Névleges szigetelési feszültség	Tartós túlterhelés	Optikai jelző	Impulzus kimenet
Forgókapcsoló	Pillanatnyi túlterhelés	Lineáris skála	Nem cserélhető skálalap
Tartós túlterhelés	AC feszültségmérés	Alacsony elemfeszültség kijelzés	Polaritás kijelzés
Pillanatnyi túlterhelés	Diódateszt	Elemteszt	Logaritmus skála
AC árammérés	Névleges feszültség (V)	Tranzisztor erősítési tényező mérés	Zárópecsételhető
DC feszültségmérés	Környezeti hőmérséklet	Szerelősínre szerelhető	DC árammérés
Ellenállásmérés	Beköthető vezeték	Tárolási hőmérséklet	Hőmérsékletmérés
Üzemi hőmérséklet	Kapcsok védettsége (burkolattal)	Anyag: ABS	Lángállóság UL94 szerint
Védettségi fokozat	Impulzus generátor	Kontaktus nélküli feszültségérzékelés	Lézer osztály: 2
Lézer sugárzás veszély			

				
Változó áramú feszültségmérő 2	Közvetlen egyenáramú árammérők 3	Változó áramú árammérők közvetett méréshez, cserélhető skálalappal 4	Egyenáramú árammérők közvetett méréshez, cserélhető skálalappal 5	Teljesítménymérők 6
				
Frekvenciamérők 7	Teljesítménytényező (cos φ) mérők 7	Üzemóraszámlálók 8	Söntök 8	Sorolható analóg voltmérők 9
				
Sorolható analóg DC alaplmszer sönt méréshez 9	Sorolható analóg frekvenciamérő 10	Sorolható analóg teljesítménytényező-mérők 10	Sorolható digitális mérőműszerek 10	Sorolható analóg teljesítménymérők 11
				
Közvetlen digitális árammérő műszer 12	Digitális teljesítménytényező-mérő 14	Digitális multiméterek 15	Hálózati analízátor 17	Közvetlen fogyasztásmérő 18
				
Áramváltós fogyasztásmérő, 1 fázisú 19	Átfűzős fogyasztásmérő, 1 fázisú 19	Dugaszolható digitális fogyasztásmérő 20	Maddteljesítmény-szabályzók 21	Kisfeszültségű áramváltók 26
				
Hitelesíthető áramváltók 28	Digitális multiméter 30	Digitális lakatfogó 32	Vezeték követő 32	Gépjármű próbálampa 33
				
Fáziskereső csavarhúzó 33	Indukciós ellenőrző készülék 33	Lézerszer távolságmérő 33		



Váltakozó áramú feszültségmérők

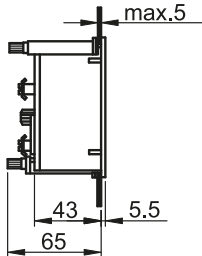
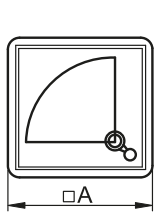
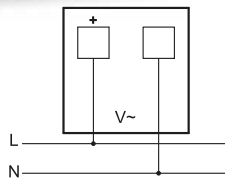
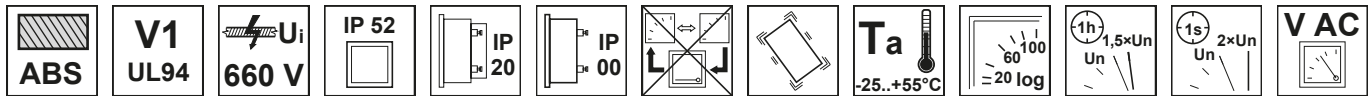

TRACON				
ACVM96-30	96 × 96 mm	0-30 V	1,5 %	90 mm
ACVM96-120	96 × 96 mm	0-120 V	1,5 %	90 mm
ACVM96-250	96 × 96 mm	0-250 V	1,5 %	90 mm
ACVM96-450	96 × 96 mm	0-500 V	1,5 %	90 mm
ACVM96-600	96 × 96 mm	0-600 V	1,5 %	90 mm
ACVM72-30	72 × 72 mm	0-30 V	1,5 %	66 mm
ACVM72-120	72 × 72 mm	0-120 V	1,5 %	66 mm
ACVM72-250	72 × 72 mm	0-250 V	1,5 %	66 mm
ACVM72-450	72 × 72 mm	0-500 V	1,5 %	66 mm
ACVM72-600	72 × 72 mm	0-600 V	1,5 %	66 mm
ACVM48-30	48 × 48 mm	0-30 V	1,5 %	42 mm
ACVM48-120	48 × 48 mm	0-120 V	1,5 %	42 mm
ACVM48-250	48 × 48 mm	0-250 V	1,5 %	42 mm
ACVM48-450	48 × 48 mm	0-500 V	1,5 %	42 mm
ACVM48-600	48 × 48 mm	0-600 V	1,5 %	42 mm

RELEVANT STANDARD
EN 60051

RELEVANT STANDARD
EN 61010

Egyenáramú feszültségmérők

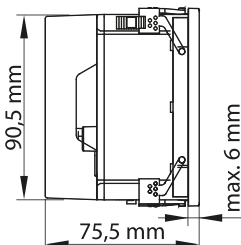
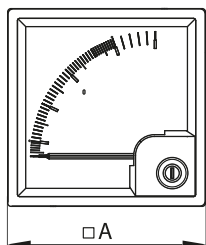
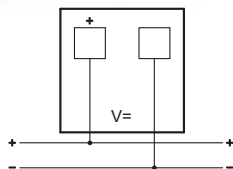
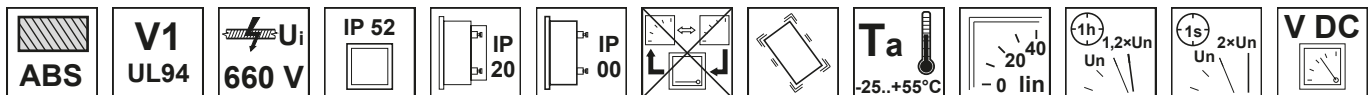

TRACON				
DCVM96-30	96 × 96 mm	0-30 V	1,5 %	90 mm
DCVM96-120	96 × 96 mm	0-120 V	1,5 %	90 mm
DCVM96-250	96 × 96 mm	0-250 V	1,5 %	90 mm
DCVM96-400	96 × 96 mm	0-400 V	1,5 %	90 mm
DCVM96-600	96 × 96 mm	0-600 V	1,5 %	90 mm
DCVM72-30	72 × 72 mm	0-30 V	1,5 %	66 mm
DCVM72-120	72 × 72 mm	0-120 V	1,5 %	66 mm
DCVM72-250	72 × 72 mm	0-250 V	1,5 %	66 mm
DCVM72-400	72 × 72 mm	0-400 V	1,5 %	66 mm
DCVM72-600	72 × 72 mm	0-600 V	1,5 %	66 mm
DCVM48-30	48 × 48 mm	0-30 V	1,5 %	42 mm
DCVM48-120	48 × 48 mm	0-120 V	1,5 %	42 mm
DCVM48-250	48 × 48 mm	0-250 V	1,5 %	42 mm
DCVM48-400	48 × 48 mm	0-400 V	1,5 %	42 mm
DCVM48-600	48 × 48 mm	0-600 V	1,5 %	42 mm

RELEVANT STANDARD
EN 60051



Közvetlen váltakozó áramú árammérők

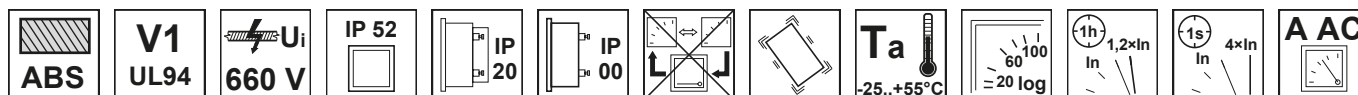

TRACON				
ACAM96-5	96 × 96 mm	0-5 A	1,5 %	90 mm
ACAM96-10	96 × 96 mm	0-10 A	1,5 %	90 mm
ACAM96-30	96 × 96 mm	0-30 A	1,5 %	90 mm
ACAM96-50	96 × 96 mm	0-50 A	1,5 %	90 mm
ACAM96-75	96 × 96 mm	0-75 A	1,5 %	90 mm
ACAM96-105	96 × 96 mm	0-100 A	1,5 %	90 mm
ACAM72-5	72 × 72 mm	0-5 A	1,5 %	66 mm
ACAM72-10	72 × 72 mm	0-10 A	1,5 %	66 mm
ACAM72-30	72 × 72 mm	0-30 A	1,5 %	66 mm
ACAM72-50	72 × 72 mm	0-50 A	1,5 %	66 mm
ACAM72-75	72 × 72 mm	0-75 A	1,5 %	66 mm
ACAM48-5	48 × 48 mm	0-5 A	1,5 %	42 mm

RELEVANT STANDARD
EN 60051

RELEVANT STANDARD
EN 61010

Lágyvasas mérőművel rendelkező műszerek, amelyek a váltakozó áramú hálózatok áramértékeinek valós effektív értékét közvetlenül jelenítik meg 0-100 A-es mérési tartományban, bármilyen utólagosan beépített tartozék nélkül. A logaritmus beosztású skálalap kialakítása olyan, hogy a műszer végkitérése a méréshatár kétszeres értéke.

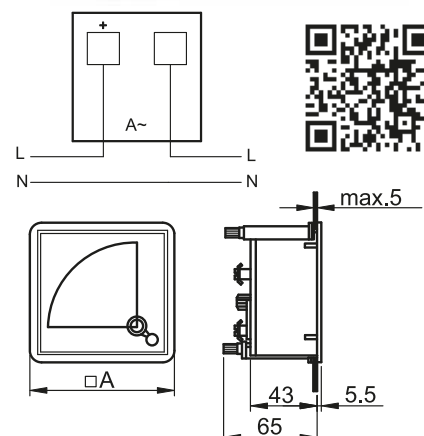

Közvetlen egyenáramú árammérők

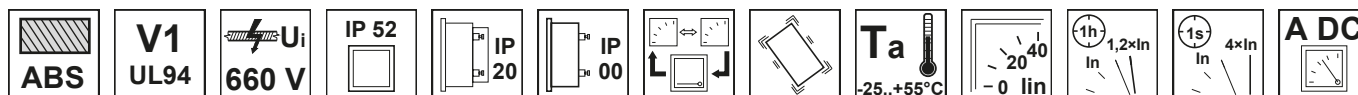

Egyenáramú milliampmérők

TRACON				
DCAM96-0,02	96 × 96 mm	0-20 mA	1,5 %	90 mm
DCAM72-0,02	72 × 72 mm	0-20 mA	1,5 %	66 mm
DCAM48-0,02	48 × 48 mm	0-20 mA	1,5 %	42 mm

Egyenáramú ampermérők

TRACON				
DCAM96-5	96 × 96 mm	0-5 A	1,5 %	90 mm
DCAM96-20	96 × 96 mm	0-20 A	1,5 %	90 mm
DCAM72-5	72 × 72 mm	0-5 A	1,5 %	66 mm
DCAM72-20	72 × 72 mm	0-20 A	1,5 %	66 mm
DCAM48-5	48 × 48 mm	0-5 A	1,5 %	42 mm
DCAM48-20	48 × 48 mm	0-20 A	1,5 %	42 mm

RELEVANT STANDARD
EN 60051

RELEVANT STANDARD
EN 61010

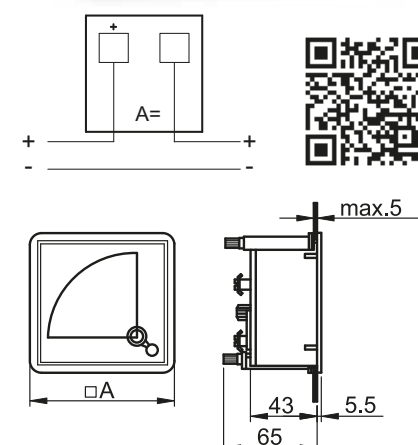

Váltakozó áramú árammérők közvetett méréshez, cserélhető skálalappal

Olyan mérőműszerek, amelyek erősáramú hálózatok áramértékeinek közvetett mérésére használatosak. A műszerek mérési tartományának kiterjesztése áramváltó használatával történik, melynek 5 A-es szekunder áramkörébe váltakozóáramú alpműszer van kötve. Az alpmérőhöz 0-X mérési tartományú skálalap rendelhető, a mellékelt táblázat szerint.

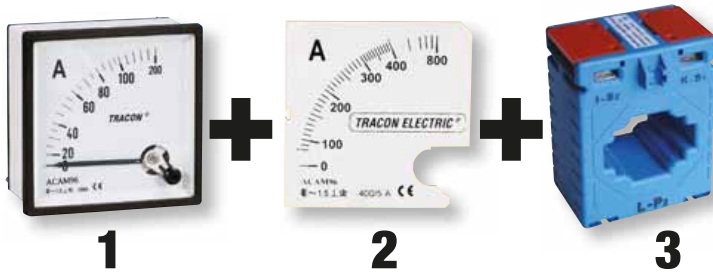

(1) Váltakozó áramú alpműszerek

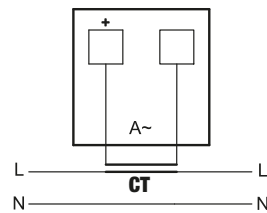
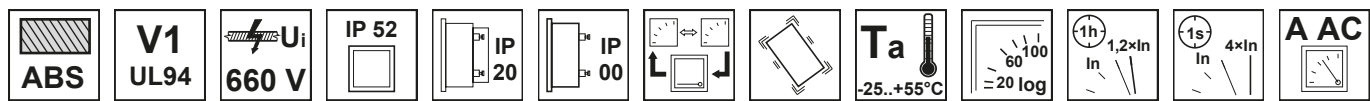

RELEVANT STANDARD
EN 60051

RELEVANT STANDARD
EN 61010

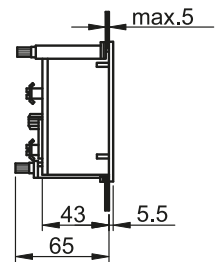
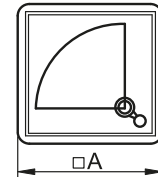

TRACON				
ACAM96-5	96 × 96 mm	0-5 A	1,5 %	90 mm
ACAM72-5	72 × 72 mm	0-5 A	1,5 %	66 mm
ACAM48-5	48 × 48 mm	0-5 A	1,5 %	42 mm

(2) Skálalapok ACAM... árammérőkhöz

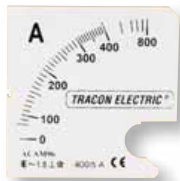

TRACON		
SCALE-AC96-X/5A	96 × 96 mm	0-X (A)
SCALE-AC72-X/5A	72 × 72 mm	0-X (A)
SCALE-AC48-X/5A	48 × 48 mm	0-X (A)

Kérjük a megrendelésnél a méréshatár X értékét feltüntetni a kívánt áramérték szerint!

(3) Áramváltók és skálalapok összerendelési táblázata közvetett áramméréshez



L/26

0-X	0-X	0-X	0-X	0-X	0-X	0-X	0-X
30/5	0-30 A	120/5	0-120 A	400/5	0-400 A	1500/5	0-1500 A
40/5	0-40 A	125/5	0-125 A	500/5	0-500 A	2000/5	0-2000 A
50/5	0-50 A	150/5	0-150 A	600/5	0-600 A	2500/5	0-2500 A
60/5	0-60 A	200/5	0-200 A	750/5	0-750 A	3000/5	0-3000 A
75/5	0-75 A	250/5	0-250 A	800/5	0-800 A	4000/5	0-4000 A
80/5	0-80 A	300/5	0-300 A	1000/5	0-1000 A	5000/5	0-5000 A
100/5	0-100 A						

Kérjük a megrendelésnél a méréshatár X értékét feltüntetni a kívánt áramérték szerint!

Egyenáramú közvetett árammérés 0-75 mV-os feszültségmérővel és sönttel, cserélhető skálalappal



Olyan mérőműszerek, amelyek erősáramú hálózatok áramértékeinek közvetett mérésére használhatók. A műszerek mérési tartományának kiterjesztése sönt segítségével történik, amelynek mérőkapcsaihoz 0-75 mV-os feszültségtartományú alaplapszer van csatlakoztatva. Az alaplapszerhez 0-X mérési tartományú skálalap rendelhető, a mellékelt táblázat szerint.

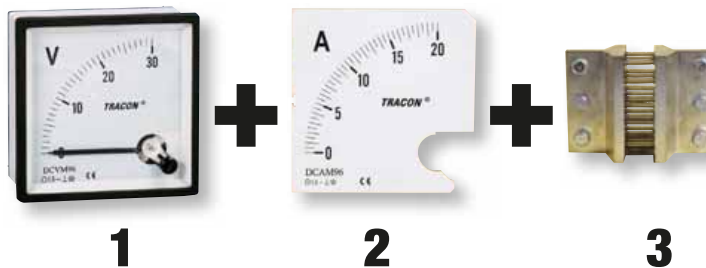

(1) Egyenáramú alaplapszer

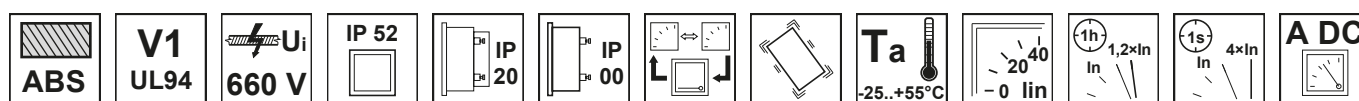

TRACON				
DCVM-96B	96 × 96 mm	0-75 mV	1,5 %	90 mm
DCVM-72B	72 × 72 mm	0-75 mV	1,5 %	66 mm
DCVM-48B	48 × 48 mm	0-75 mV	1,5 %	42 mm

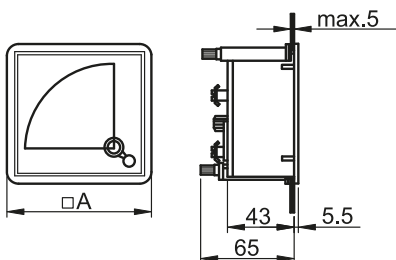

**RELEVANT STANDARD
EN 60051**

**RELEVANT STANDARD
EN 61010**

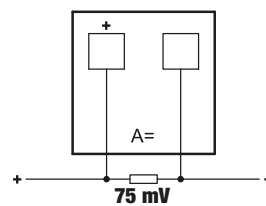

(2) Skálalapok egyenáram méréséhez

TRACON		
SCALE-DC96-X/75mV	96 × 96 mm	0-X (A)
SCALE-DC72-X/75mV	72 × 72 mm	0-X (A)
SCALE-DC48-X/75mV	48 × 48 mm	0-X (A)

Kérjük a megrendelésnél a méréshatár X értékét feltüntetni a kívánt áramérték szerint!



(3) Söntök és skálalapok összerendelési táblázata közvetett áramméréshez

75mV	0-X	75mV	0-X	75mV	0-X	75mV	0-X
TSF-30	0-30 A	TSF-100	0-100 A	TSF-400	0-400 A	TSF-1000	0-1000 A
TSF-40	0-40 A	TSF-150	0-150 A	TSF-500	0-500 A	TSF-1500	0-1500 A
TSF-50	0-50 A	TSF-200	0-200 A	TSF-600	0-600 A	TSF-2000	0-2000 A
TSF-75	0-75 A	TSF-300	0-300 A	TSF-750	0-750 A	TSF-3000	0-3000 A

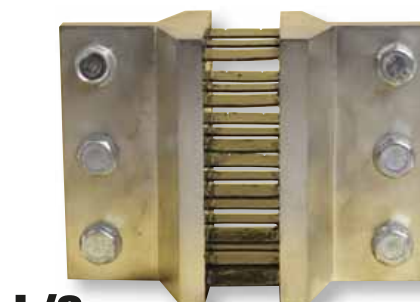

L/8

Kérjük a megrendelésnél a méréshatár X értékét feltüntetni a kívánt áramérték szerint!



Teljesítménymérők

Egy- ill. háromfázisú terhelések hatásos teljesítményét mérik. Olyan mérőműszerek, amelyek mérési tartománya az alkalmazott 5 A szekunder áramú áramváltók primer árama (X) szerint van meghatározva. A 96 × 96 mm-es változatoknál a mérőátalakító műanyagháza és az alpműszer szerves egységet képez, míg a 72 × 72 mm-es kivitel esetén a vezérlőelektronikát külön szállítjuk, és a vezérlőszekrényben külön is kell azt elhelyezni. A mérőműszerekhez skálapalpa rendelhető, a mellékelt táblázat szerint.



(1) Teljesítménymérők

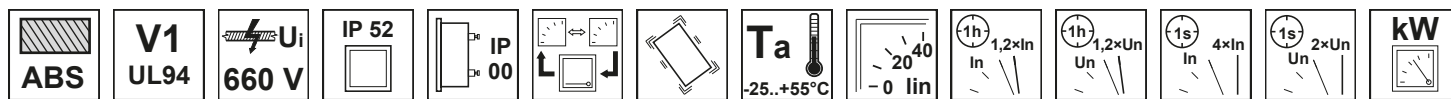

TRACON			U_n	I_n				
W96-400V/4	96 × 96 mm	0-100	400 V~	X/5 A	1,5 %	90 mm	× 3	L1, L2, L3, N
W72-400V/4	72 × 72 mm	0-100	400 V~	X/5 A	1,5 %	66 mm	× 3	L1, L2, L3, N

(2) Skálapalpa teljesítményméréshez

	TRACON L1, L2, L3, N		
SCALE-W96/4-P	96 × 96 mm	0-P (kW)	
SCALE-W72/4-P	72 × 72 mm	0-P (kW)	

Kérjük megrendelésnél az X és P értékeket feltüntetni!

(3) Áramváltók és skálapalpa összerendelési táblázata egy- ill. háromfázisú teljesítményméréshez

3~	3~	3~	3~	3~	3~
30/5	24 kW	125/5	100 kW	750/5	600 kW
40/5	32 kW	150/5	120 kW	800/5	640 kW
50/5	40 kW	200/5	160 kW	1000/5	800 kW
60/5	48 kW	250/5	200 kW	1500/5	1200 kW
75/5	60 kW	300/5	240 kW	2000/5	1600 kW
80/5	64 kW	400/5	320 kW	2500/5	2000 kW
100/5	80 kW	500/5	400 kW	4000/5	3200 kW
120/5	96 kW	600/5	480 kW	5000/5	4000 kW



L/26

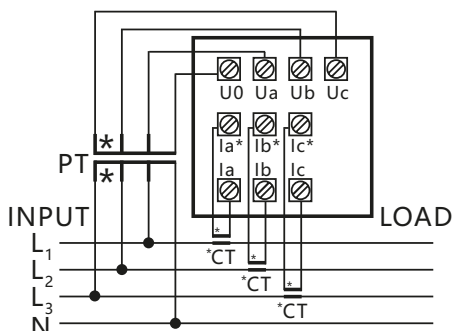

Jelmagyarázat
CT=áramváltó



Frekvenciamérők

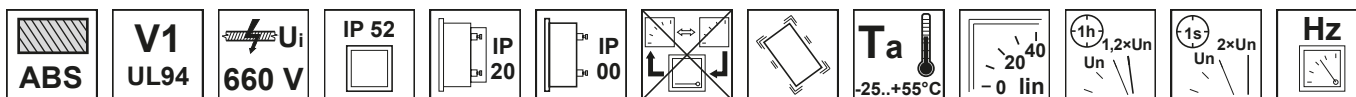

TRACON				
F96-220/50	96 × 96 mm	45-55 Hz (230 V)	1,5 %	90 mm
F48-220/50	48 × 48 mm	45-65 Hz (230 V)	2,5 %	42 mm

Kisfeszültségű hálózatok frekvenciáját mérik 45-55 Hz frekvenciatartományban. A készülék mérőkapcsaira a hálózati feszültséget kell csatlakoztatni, a műszer a házban elhelyezett mérőátalakító segítségével a frekvencia értékét mutatja.

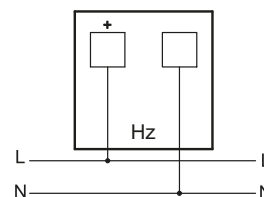
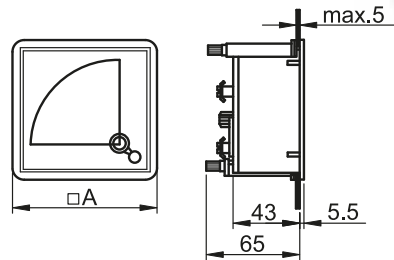

RELEVANT STANDARD
EN 60051

RELEVANT STANDARD
EN 61010

Teljesítménytényező (cos φ) mérők

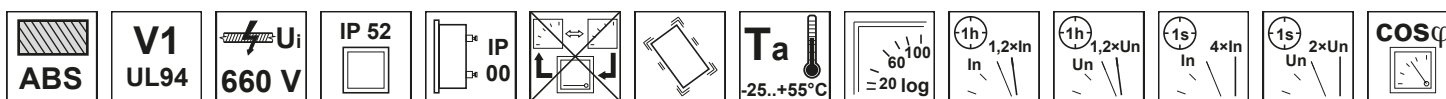

TRACON			U_n	I_n		
CF96-0,5/1	96 × 96 mm	0,5 cap-1-0,5 ind	240 V~	X/5 A	1,5 %	90 mm
CF72-0,5/1	72 × 72 mm	0,5 cap-1-0,5 ind	240 V~	X/5 A	1,5 %	66 mm
CF96-0,5/3	96 × 96 mm	0,5 cap-1-0,5 ind	400 V~	X/5 A	2,5 %	90 mm
CF72-0,5/3	72 × 72 mm	0,5 cap-1-0,5 ind	400 V~	X/5 A	2,5 %	66 mm

Egy- ill. háromfázisú hálózatok teljesítménytényezőjét mérik 0,5 kapacitív – 0,5 induktív tartományban. A mérőműszer árammérő körében 5 A-nél nagyobb mérendő áram esetén 5 A szekunder áramú áramváltót kell alkalmazni. A hálózat kapacitív vagy induktív jellegéből adódóan a mutató a szimmetrikus skálalap bal (kapacitív) vagy jobb (induktív) irányába tér ki. A mérőátalakító a műszerházba van beépítve.



Terhelés jellege
Lead=kapacitív,
Lag=induktív

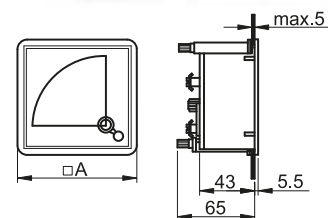

Bekötési rajzok egyfázisú hálózat esetén

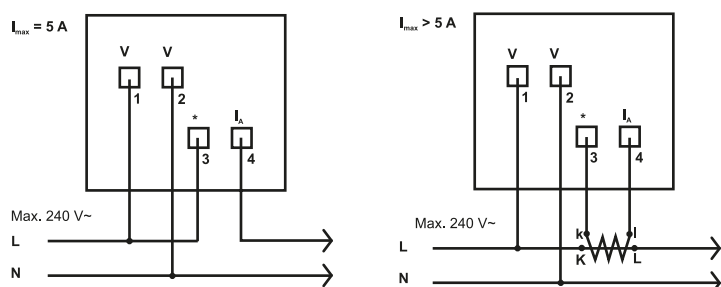

Bekötési rajzok háromfázisú hálózat esetén

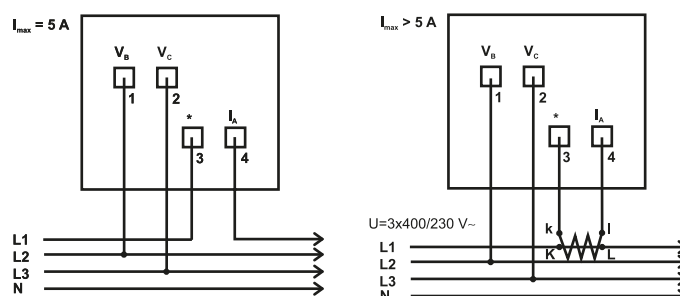

Üzemóraszámlálók

ABS	V1 UL94	660 V	IP 40	IP 20	IP 00	Ta -25..+55°C	0014 analog	000000 99999,9	Piktogramok	L/O
-----	------------	-------	-------	-------	-------	------------------	----------------	-------------------	-------------	-----

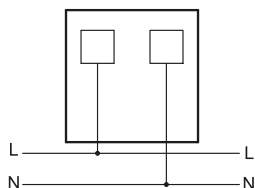

TRACON		
ISZ72-230	72 × 72 mm	66 mm
ISZ96-24	96 × 96 mm	90 mm
ISZ96-230	96 × 96 mm	90 mm

A műszerek kijelzője nem nullázható!

Söntök

TRACON		L (mm)	C (mm)	B (mm)	H (mm)	M (mm)
TSF-30	30A/75mV	120	102	25	15	-
TSF-40	40A/75mV	120	102	25	15	-
TSF-50	50A/75mV	120	102	25	15	-
TSF-75	75A/75mV	110	86	23	10	M8 × 35
TSF-100	100A/75mV	106	86	23	10	M8 × 35
TSF-150	150A/75mV	116	86	21	22	M8 × 35
TSF-200	200A/75mV	116	86	21	22	M8 × 35
TSF-300	300A/75mV	127	100	26	22	M10 × 35

TRACON		L (mm)	C (mm)	B (mm)	H (mm)	M (mm)
TSF-400	400A/75mV	126	100	35	22	M10 × 35
TSF-500	500A/75mV	126	100	43	22	M10 × 35
TSF-600	600A/75mV	126	100	50	22	M10 × 35
TSF-750	750A/75mV	126	102	74	22	M10 × 35
TSF-1000	1000A/75mV	126	102	94	22	M12 × 60
TSF-1500	1500A/75mV	200	164	90	96	M12 × 60
TSF-2000	2000A/75mV	194	160	90	96	M12 × 60
TSF-3000	3000A/75mV	198	160	142	96	M12 × 60

A söntön átfolyó áram hatására a sönt két kapcsa között létrejövő feszültségesés arányos a sönt ellenállásával. Ezt a tény felhasználva, az áram által átjárt ismert ellenállás két végpontján mérhető feszültségből az áramkörben folyó áram nagysága meghatározható.

Az ábra szerinti mérési összeállításban a mV műszer az Rs söntön létrejövő Um feszültségesést méri, miközben skáláján az Rs söntön átfolyó I áramerősség érték közvetlenül Amperben olvasható le.

A forgalmazott TSF jelű egyenáramú söntök mérőpontjain max. 75 mV feszültség jelenik meg, ezért a söntökhöz alkalmazható alaplakműszerek mérés-határa is 75 mV.

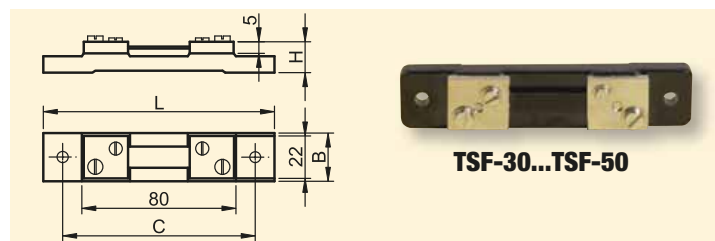
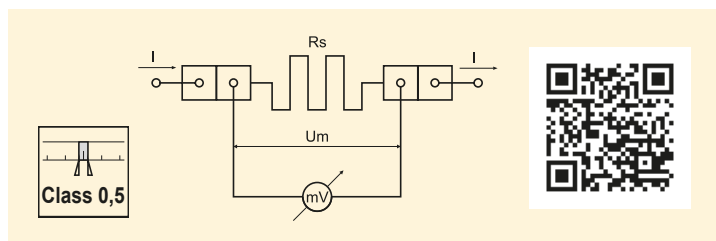

TSF-30...TSF-50

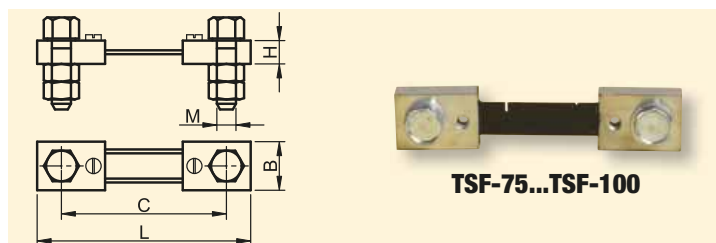

TSF-75...TSF-100

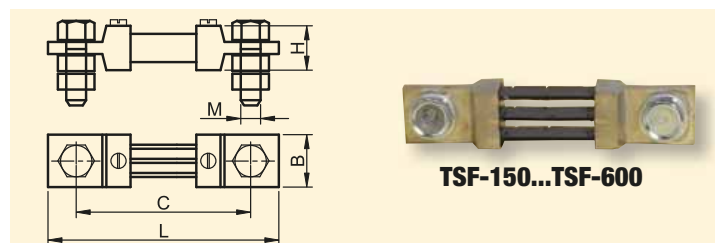

TSF-150...TSF-600

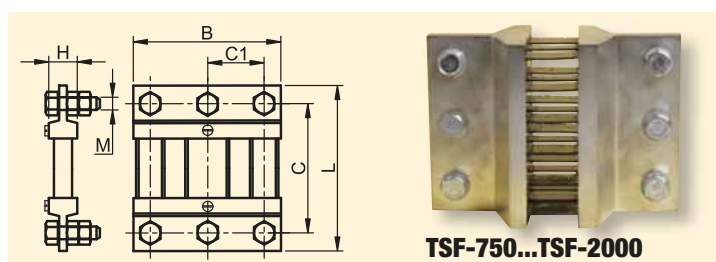

TSF-750...TSF-2000

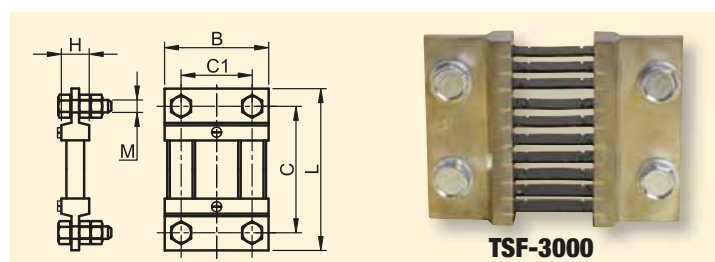

TSF-3000

Sorolható analóg voltmérők

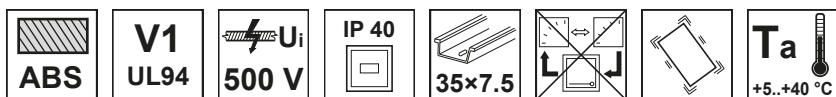

TRACON			
ACVMS-25		0-25 V	1,5 %
ACVMS-100		0-100 V	1,5 %
ACVMS-450		0-450 V	1,5 %
DCVMS-100		0-100 V	1,5 %
DCVMS-250		0-250 V	1,5 %

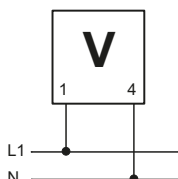
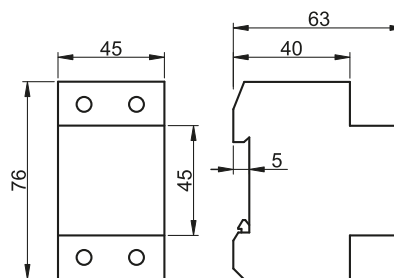

RELEVANT STANDARD
EN 60051

RELEVANT STANDARD
EN 61010

Sorolható analóg ampermérők közvetlen áramméréshez

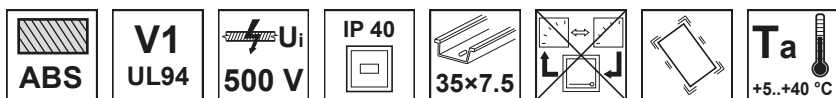

TRACON			
DCAMS-20m*		0-20 mA	1,5 %

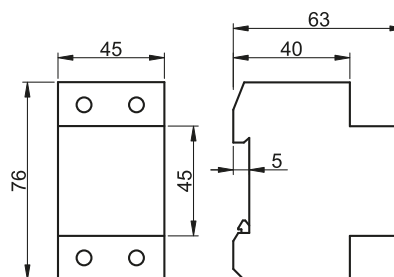

* Az egyenáramú milliampermérők elektronikai vezérlő- és szabályzó rendszerekben alkalmazhatók az unifikált áramértékek mérésére. A műszerhez – külön egyeztetés után – egyedi skálap is rendelhető, ezáltal a műszer villamos mennyiséggé alakított fizikai mennyiség (pl. erő, hőmérséklet, fordulatszám) megjelenítésére is alkalmassá tehető.

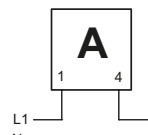

Sorolható analóg DC alpműszer sönt méréshez

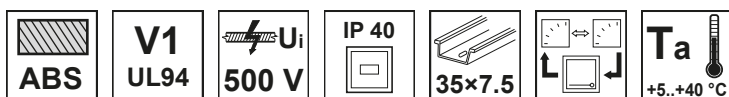

(1) Egyenáramú alpműszerek

TRACON			
DCVMS-X/75		0-X A	1,5 %

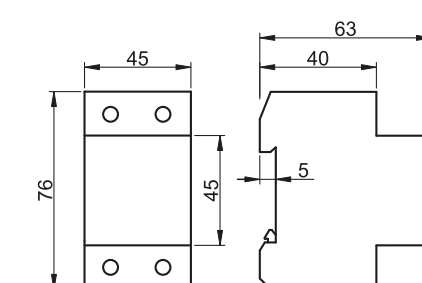

(2) Skálapok egyenáram méréséhez

TRACON		
SCALE-45 DC-X*		0-X (A)

* Kérjük a megrendelésnél a méréshatár X értékét feltüntetni a kívánt áramérték szerint!

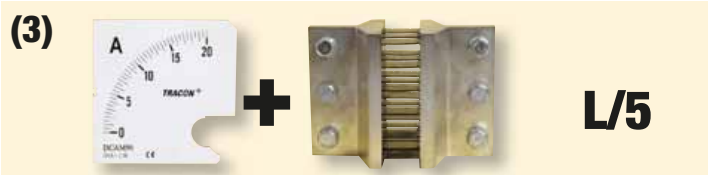

(3)

L/5

Sorolható analóg frekvenciamérő

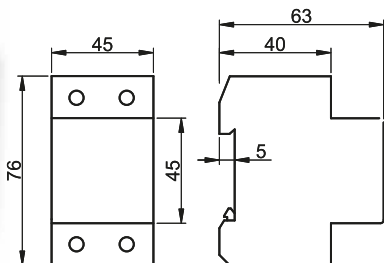
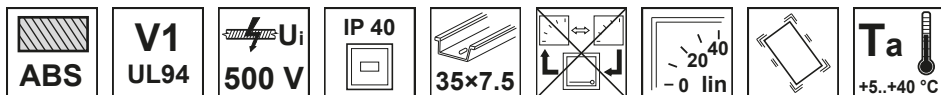

TRACON		
F45S-230/50	45-55 Hz	1,0 %

RELEVANT STANDARD
EN 60051

RELEVANT STANDARD
EN 61010

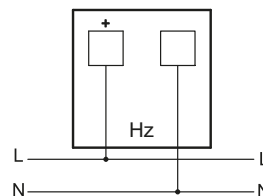

Sorolható analóg teljesítménytényező-mérők

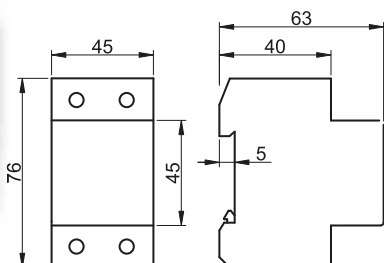
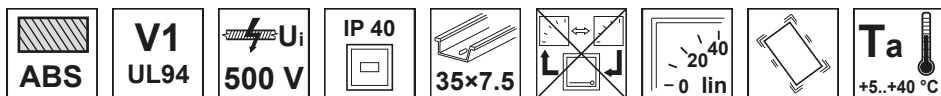

TRACON		
CF45S-0,5/1	5 A/230 V 1f ±0,5	2,5 %
CF45S-0,5/3	5 A/400 V 3f ±0,5	2,5 %

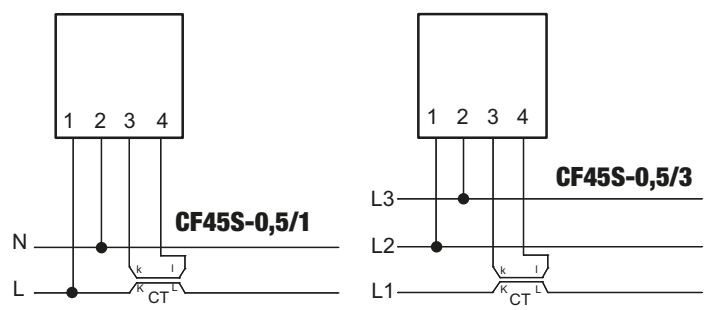

Sorolható digitális mérőműszerek

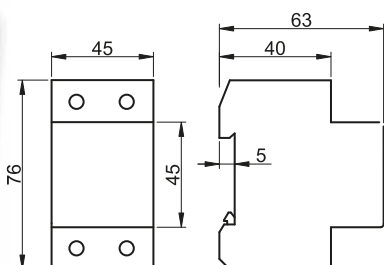
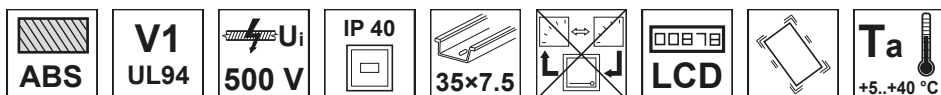

TRACON			
ACAMSD-10		0-10 A	×3 1,5 %

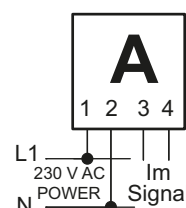

Sorolható analóg teljesítménymérők

Egy- ill. háromfázisú terhelések hatásos teljesítményét mérik. Olyan mérőműszerek, amelyek mérési tartománya az alkalmazott 5 A szekunder áramú áramváltók primer árama (X) szerint van meghatározva. A vezérlőelektronikát külön szállítjuk, és a vezérlőszekrényben külön is kell azt elhelyezni. A mérőműszerekhez skálapal rendelhető, a mellékelt táblázat szerint.

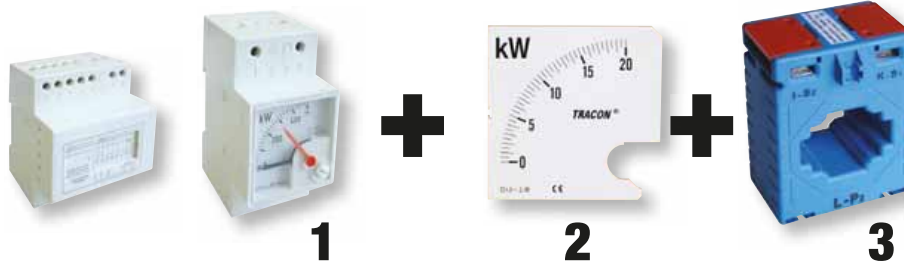
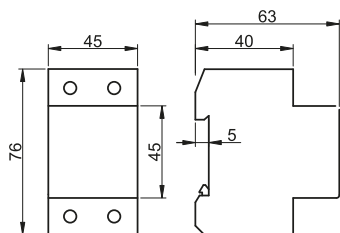

(1) Teljesítménymérők

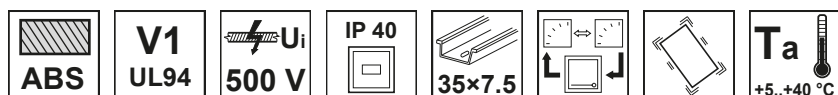

TRACON		U_n	I_n			
W45S-230/1	0-100	230 V~	X/5 A	1,5 %	×1	L1
W45S-400/4	0-100	400 V~	X/5 A	1,5 %	×3	L1, L2, L3, N

(2) Skálapalok teljesítményméréshez

TRACON			
L1	L1, L2, L3, N	0-P (kW)	1,5 %
SCALE-45 W/1-X	SCALE-45 W/4-X		



Kérjük megrendelésnél az X és P értékeket feltüntetni!

(3) Áramváltók és skálapalok összerendelési táblázata egy- ill. háromfázisú teljesítményméréshez

	1~	3~	1~	3~	1~	3~	1~	3~	1~	3~	
30/5	7,5 kW	15 kW	120/5	30 kW	60 kW	400/5	100 kW	200 kW	1500/5	375 kW	750 kW
40/5	10 kW	20 kW	125/5	31,25 kW	62,5 kW	500/5	125 kW	250 kW	2000/5	500 kW	1000 kW
50/5	12,5 kW	25 kW	150/5	37,5 kW	75 kW	600/5	150 kW	300 kW	2500/5	625 kW	1250 kW
60/5	15 kW	30 kW	200/5	50 kW	100 kW	750/5	187,5 kW	375 kW	3000/5	750 kW	1500 kW
75/5	18,75 kW	37,5 kW	250/5	62,5 kW	125 kW	800/5	200 kW	400 kW	4000/5	1000 kW	2000 kW
80/5	20 kW	40 kW	300/5	75 kW	150 kW	1000/5	250 kW	500 kW	5000/5	1250 kW	2500 kW

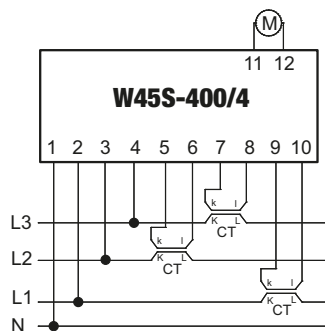
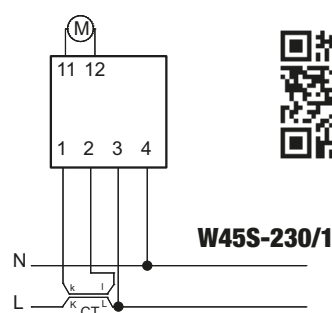

OLVASSA BE A KÓDOT!

- Nézze meg újdonságainkat
- Legyen naprakész

Kínálatunk gyorsan és folyamatosan fejlődik!
Katalógusunk a 2021. áprilisi állapotot tükrözi.
Naprakész információért
látogasson el honlapunkra!

Közvetlen digitális árammérő műszer

230 V AC	ABS	V1 UL94	U _i 660 V	IP 40	IP 20	(0,8-1,2)×U _n	Ta -25...+65°C	A AC	
----------	-----	---------	----------------------	-------	-------	--------------------------	----------------	------	--

TRACON						C (mm)	D (mm)	
ACAMD-96-50	96 × 96 mm	×3	0-50 A AC	± 2 %	91 mm	67	8	445 g
ACAMD-72-50	72 × 72 mm	×3	0-50 A AC	± 2 %	68 mm	70	6	245 g



Ez a mérőműszer képes közvetlenül mérni egy hálózat áramértékeit 50 A-ig bármilyen utólagosan beépített tartozék nélkül. A tápfeszültség csatlakoztatása a hátoldalon elhelyezett dugaszolható sorkapcsokon keresztül történik. A mérőműszer árammérő bemenete egy beépített, a hátoldalon található kisműködésű, 50/5A áttételi arányú áramváltó, melyen át kell vezetni a fázisvezetőt. A műszer teljesen automatikus működésű, előlapján a mért áramértékről egy 3 digités LED kijelző ad tájékoztatást.

RELEVANT STANDARD
EN 60051

RELEVANT STANDARD
EN 61010

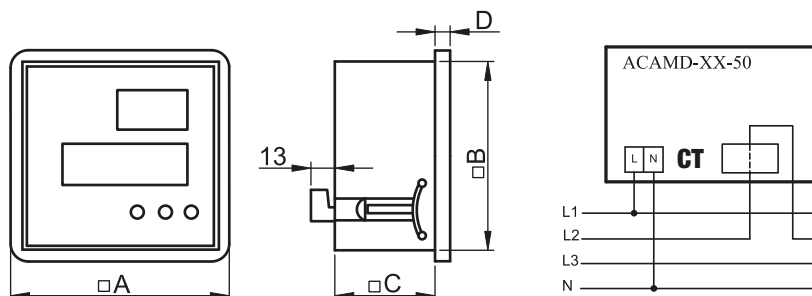

Digitális árammérő állítható áramváltó áttétellel (relékimenettel)

230 V AC	ABS	V1 UL94	U _i 660 V	IP 40	IP 20	(0,8-1,2)×U _n	Ta -25...+65°C	AUX 1×CO	[mm ²] 1-2,5	A AC
----------	-----	---------	----------------------	-------	-------	--------------------------	----------------	----------	--------------------------	------

TRACON						C (mm)	D (mm)	
ACAMD-96	96×96 mm	×4	0-9500 A AC	± 1 %	91 mm	67	8	305 g
ACAMD-72	72×72 mm	×4	0-9500 A AC	± 1 %	68 mm	70	6	250 g
ACAMD-P-96*	96×96 mm	×4	0-9500 A AC	± 1 %	91 mm	67	8	320 g
ACAMD-P-72*	72×72 mm	×4	0-9500 A AC	± 1 %	68 mm	70	6	265 g

* Programozható relékimenettel



Mindkét típusú műszer a váltakozó áram effektív értékének mérésére alkalmas, az áramváltó áttételi aránya (Ct) beállítható 5/5 – 9500/5 A értékig. A készülék programozása a mellő panelen lévő gombok segítségével történik. A mikroprocesszor alapú programozás lehetővé teszi a felhasználónak, hogy ellenőrizze a beállított Ct arányt, és hogy meghatározza a kritikus áramszintet a kívánt túláramvédelmi riasztáshoz a relé kimeneten keresztül. Az ACAMD típusú mérőműszer az ACAMD-P típus relékimenet nélküli változata.

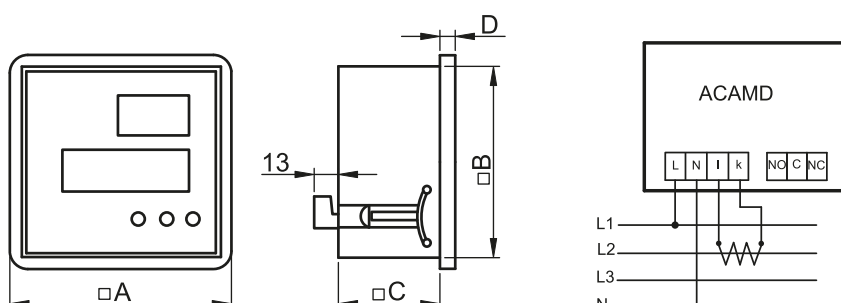

Digitális feszültségmérő műszer (fáziskiválasztással)



TRACON			U_n				C (mm)	D (mm)	
ACVMD-96-500	96 × 96 mm	×3	400 V~	0-500 V AC	± 1 %	91 mm	67	8	300 g
ACVMD-72-500	72 × 72 mm	×3	400 V~	0-500 V AC	± 1 %	68 mm	70	6	240 g
ACVMD-K-96-500*	96 × 96 mm	×3	400 V~	0-500 V AC	± 1 %	91 mm	67	8	305 g
ACVMD-K-72-500*	72 × 72 mm	×3	400 V~	0-500 V AC	± 1 %	68 mm	70	6	245 g

* A kívánt fázist az előlapon található nyomógombbal lehet kiválasztani.

Az ACVMD típusú mérőműszer egy-és háromfázisú AC rendszerek effektív feszültség értékeinek mérésére alkalmas 0-500 V között, mely értékek a kijelzőn megjeleníthetők. A tápfeszültség, a mérendő fázis és a nulla vezetékének csatlakoztatása a hátoldalon elhelyezett dugaszolható sorkapcsokon keresztül történik. Vonali feszültség mérése esetén a mérni kívánt fázisokat a V1-V2 csatlakozási pontokra kell kötni.

Fázisfeszültség mérés esetén pedig a mérni kívánt fázist és a nullvezetőt kell a V1-V2 csatlakozási pontokra kötni.

Az ACVMD-K készülékek esetén a mérendő fázisokat az L1, L2, L3 kapcsokra kell csatlakoztatni.

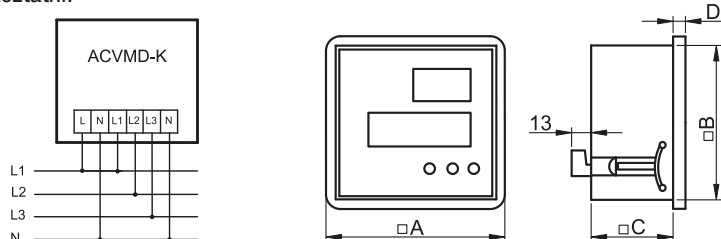
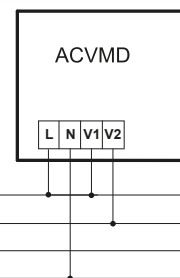

Digitális áram- és feszültségmérő műszer állítható áramváltó áttétellel

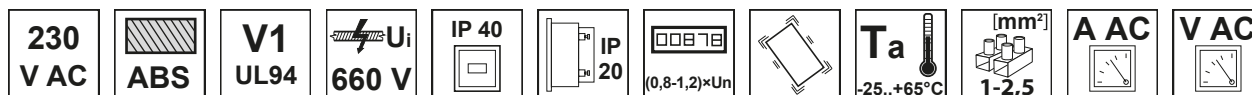





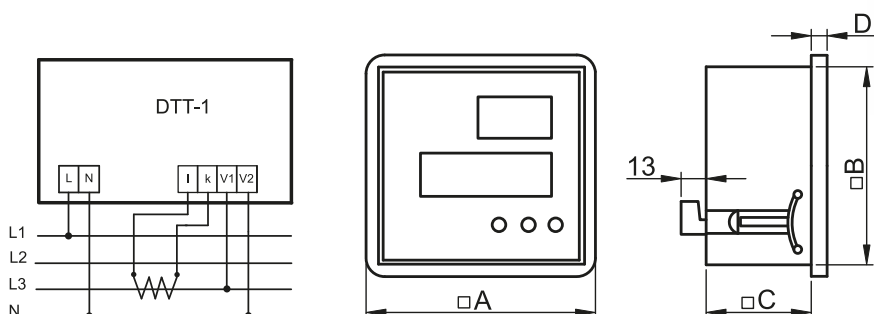

TRACON							C (mm)	D (mm)	
DTT-1-96	96×96 mm	×3/4	0-500 V AC	0-9500 A AC	± 1 %	91 mm	67	8	325 g
DTT-1-72	72×72 mm	×3/4	0-500 V AC	0-9500 A AC	± 1 %	68 mm	70	6	245 g

Olyan mikroprocesszor alapú készülék, amellyel a hozzá csatlakoztatott hálózat feszültség- és áramértékeit lehet mérni. Az áramváltó áttételi aránya (Ct) beállítható 5/5 – 9500/5 A értékig. A műszer a mennyiségek valós effektív értékét (T.R.M.S.) méri, az áttételi arány a mellső panelen lévő gombok segítségével állítható be. A tápfeszültség, az áram- és a feszültség bemenetek csatlakoztatása a hátoldalon elhelyezett dugaszolható sorkapcsokon keresztül történik. A feszültség érték 3 digitos, az áramérték 4 digitos LED kijelzőről olvasható le.



Digitális frekvenciamérő

230 V AC	ABS	V1 UL94	U_i 660 V	IP 40	IP 20	$(0,8-1,2) \times U_n$	T_a -25...+65°C	[mm ²] 1-2,5	Hz
-------------	-----	------------	----------------	-------	-------	------------------------	----------------------	-----------------------------	----

TRACON	 A	 digit	 Hz	 ha %		C (mm)	D (mm)	 m
FD-96	96 × 96 mm	×3	45-75 Hz	± 1 %	91 mm	67	8	445 g
FD-72	72 × 72 mm	×3	45-75 Hz	± 1 %	68 mm	70	6	245 g



Érzékeny és pontos mérőeszköz mikroprocesszor vezérléssel, mely a hálózat frekvenciáját méri. A mért frekvencia a 3 digités LED kijelzőjéről olvasható le. A tápfeszültség csatlakoztatása a hátoldalon elhelyezett dugaszolható sorkapcsokon keresztül történik.





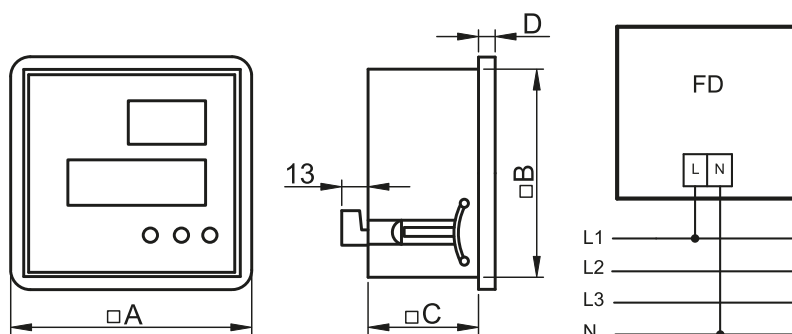

RELEVANT STANDARD
EN 60051

RELEVANT STANDARD
EN 61010



Digitális teljesítménytényező-mérő

230 V AC	ABS	V1 UL94	U_i 660 V	IP 40	IP 20	$(0,8-1,2) \times U_n$	T_a -25...+65°C	[mm ²] 1-2,5	$\cos \varphi$
-------------	-----	------------	----------------	-------	-------	------------------------	----------------------	-----------------------------	----------------

TRACON	 A	 digit	 W	 ha %		C (mm)	D (mm)	 m
CFD-96	96 × 96 mm	×3	0,1-0,99	± 1 %	91 mm	67	8	305 g
CFD-72	72 × 72 mm	×3	0,1-0,99	± 1 %	68 mm	70	6	250 g



Olyan mérőműszer, mellyel egy meglévő hálózat teljesítménytényezőjét lehet mérni egy- és háromfázisú rendszerekben. A készülék teljesen mikroprocesszor vezérlésű intelligens mérőműszer. A mért teljesítménytényező a műszer 3 digités LED kijelzőjéről olvasható le. A tápfeszültség csatlakoztatása a hátoldalon elhelyezett dugaszolható sorkapcsokon keresztül történik. A teljesítménytényező jellegéről az előlapon elhelyezett LED-ek nyújtanak tájékoztatást. 5 A-nél nagyobb áram esetén áramváltót kell alkalmazni.



L/26

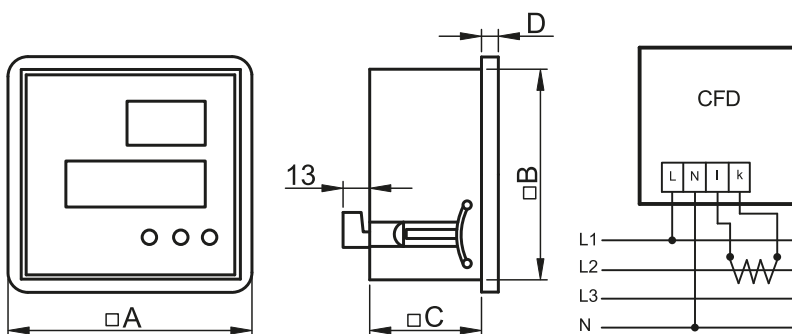

Digitális multiméterek

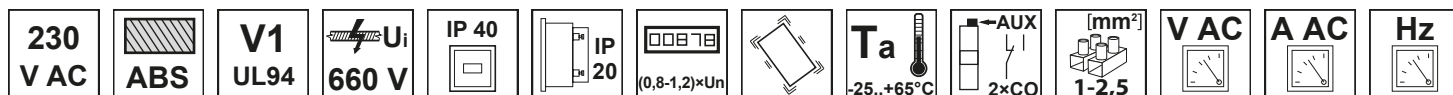

TRACON									
		×digit	L-N	L-L	A	Hz	± 1 %	92 mm	470 g
DTT-2	96 × 96 mm	×4	0-300 V AC	0-500 V AC	0-9500 A AC	40-99,9 Hz	± 1 %	92 mm	470 g
DTT-3*	96 × 96 mm	×4	0-300 V AC	0-500 V AC	0-9500 A AC	40-99,9 Hz	± 1 %	92 mm	515 g

* Programozható relékimenettel

Olyan mikroprocesszor alapú mérőműszerek, melyek a hálózat frekvenciáját valamint mindhárom fázis áram- és feszültség valós effektív értékét (T.R.M.S.) mérik. A készülék tárolja az áram és feszültség minimum és maximum értékeit és képes mutatni azokat a felhasználó beállítása szerint. A DTT-3 típusnak programozható az alsó és felső feszültség-, illetve alsó és felső áramhatárai, valamint a késleltetési ideje. A DTT-2 típus a DTT-3 típusú műszer relékimenet nélküli változata.

A DTT-3 típusnak két különálló potenciálfüggetlen relékimenete van, külön az áram és külön a feszültség hibák jelzésére. A tápfeszültség és a mérő bemenetek csatlakoztatása a hátoldalon elhelyezett dugaszolható sorkapcsokon keresztül történik.

A műszer mindhárom fázis áramának ill. a hálózat frekvenciájának pillanatnyi értékét közvetlenül jelzi ki.

Az előlapon elhelyezett nyomógombok segítségével választhatók ki a vonali- ill. fázisfeszültségek, melynek pillanatnyi értékei a kijelzőről szintén leolvashatók. A kiválasztott fázist LED indikátor jelzi. Az áramváltó áttételi arányának (Ct) beállítását szintén az előlapon található nyomógombok segítségével végezhetjük el.

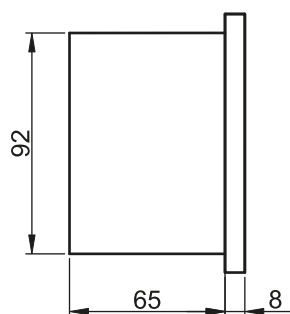
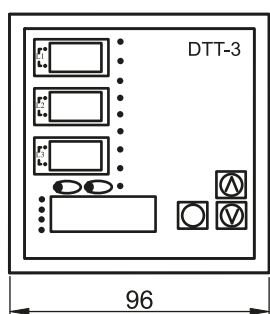
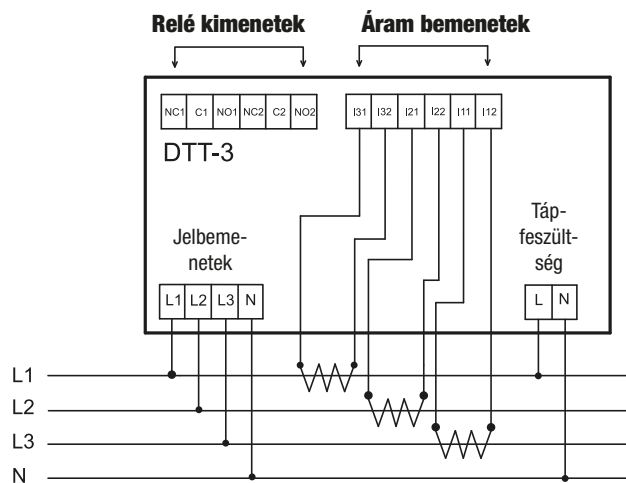
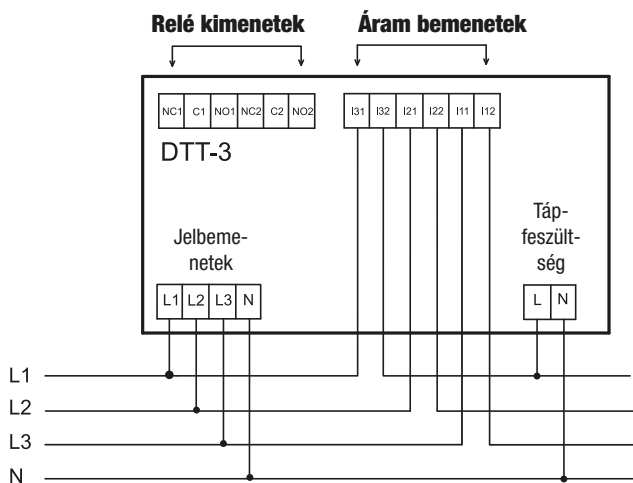

RELEVANT STANDARD
EN 60051

RELEVANT STANDARD
EN 61010



L/26

Állapotfigyelő intelligens multiméter

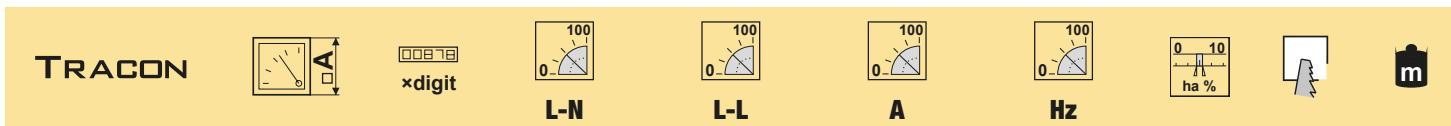
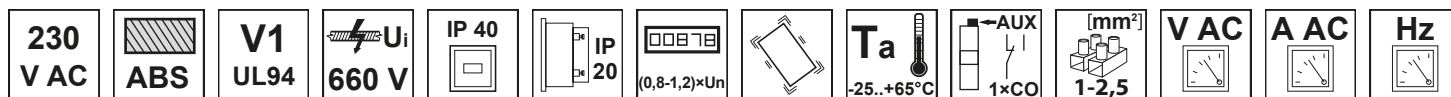

DTT-5 96 × 96 mm ×3 0-280 V AC 0-500 V AC 0-9500 A AC 45-70 Hz ± 1 % 92 mm 305 g



RELEVANT STANDARD
EN 60051

RELEVANT STANDARD
EN 61010

Képes mérni egy háromfázisú hálózat áram, feszültség és frekvencia értékeit. Arra tervezték, hogy megtalálja és közölje a fenyegető mechanikai és elektronikai hibákat háromfázisú motorokban. A detektáló multiméter technológiájának köszönhetően lehetőség nyílik egy olyan megbízható rendszerellenőrzésre, melynél az esetleges hibákat még a bekövetkezésük előtt észlelhetjük és kijavíthatjuk, elősegítve a termelékenységet a minőségi termelésben. A mért min/max áramértékeket elmenti a készülék a memóriájába, és kívánság szerint megjeleníti. Ezenkívül a műszer rendelkezik állítható alsó/felső áram és feszültségvédelmi szinttel, állítható időkéstelletéssel, valamint a kimeneten a riasztásokhoz prioritás beállítási lehetőséggel. A műszer a mennyiségek előzőleg tárolt referenciaértékét hasonlítja össze ezek pillanatnyi értékével, és az esetleges eltérés nagyságának figyelembevételével fokozatosan aktiválja a riasztás egyes szintjeit. A műszer riasztáskimenete egy potenciálfüggetlen váltóérintkező, mely áram- vagy feszültséghibára egyaránt működhet. A programozható relékimenettel megadható, hogy a beállított áram- vagy feszültséghiba esetén a riasztáskimenet a riasztásprioritás mely szintjén váltson állapotot. A tápfeszültség és a mérő bemenetek csatlakoztatása a hátoldalon elhelyezett dugaszolható sorkapcsokon keresztül történik. A mért mennyiségek pillanatnyi értékéről az előlapon elhelyezett 3 digitális LED kijelzők adnak tájékoztatást. A kiválasztott mennyiséget LED indikátor jelzi. Az áramváltó áttételi arányának (Ct) beállítását az előlapon található nyomógombok segítségével végezhetjük el.

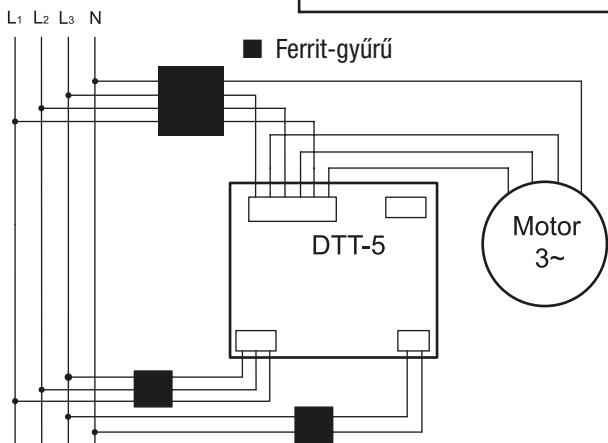

Áramváltók használata nélkül

A csatlakozó vezetékeket az ábrák szerint át kell fűzni a ferrit-gyűrűkön az elektromágneses zavarok kiszűrése érdekében.

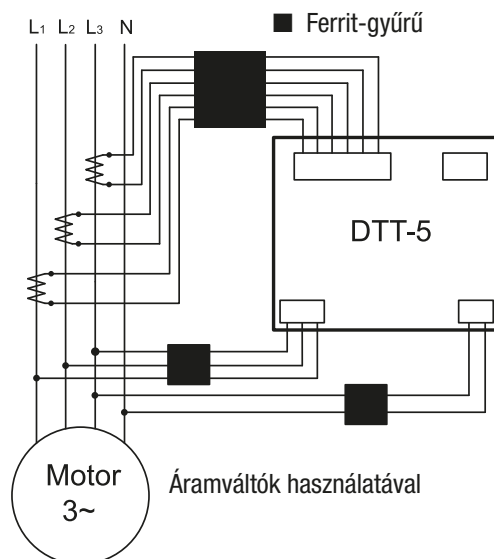

Áramváltók használatával

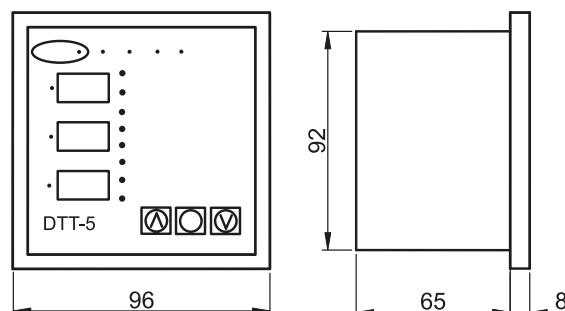

Hálózati analizátor

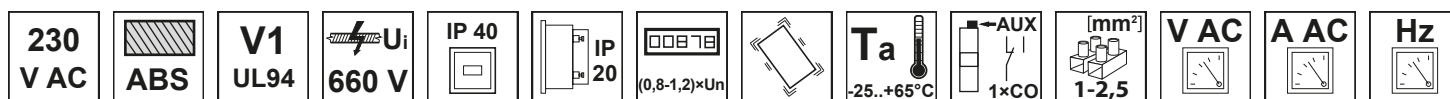

TRACON										
DTT-4	96 × 96 mm	×3/7	0-280 V AC	0-500 V AC	0-9500 A AC	45-70 Hz	± 1 %	± 2 %	92 mm	500 g

Olyan készülék, mely ideális az egyfázisú és háromfázisú hálózatok paramétereinek mérésére, ellenőrzésére és a hibás értékek jelzésére. Az áramok, a fázis- és vonali feszültségeken kívül frekvencia, teljesítménytényező, hatásos-, látszólagos-, meddő teljesítmény és energia is mérhető, képet kaphatunk a feszültségek és áramok felharmonikus tartalmáról is a hálózatban. A műszer 75 különböző mennyiség mérésére alkalmas, melyek értékei négy Led kijelzőn jeleníthetők meg. A készülék a mennyiségek valós effektív értékét (T.R.M.S.) méri, rendelkezik két potenciálfüggetlen, külön programozható relékimenettel, melyek riasztás esetén váltanak állapotot a felhasználó által beállított határértékek szerint. A kiválasztott mennyiséget LED indikátor jelzi. A tápfeszültség és a mérő bemenetek csatlakoztatása a hátoldalon elhelyezett dugaszolható sorkapcsokon keresztül történik. Az áramváltó áttételi arányának (Ct) beállítását, a készülék programozását és a kijelzeni kívánt mennyiséget az előlapon található nyomógombok segítségével végezhetjük el. A készülék teljesen automatikus működésű, használata előnyös minden olyan helyen, ahol a villamos mennyiségek mérése mellett elsődleges cél az energiaellátás minőségének ellenőrzése is.

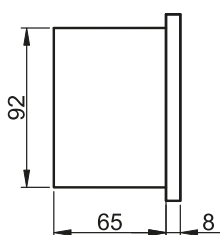
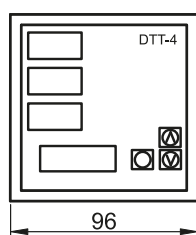

**RELEVANT STANDARD
EN 60051**

**RELEVANT STANDARD
EN 61010**

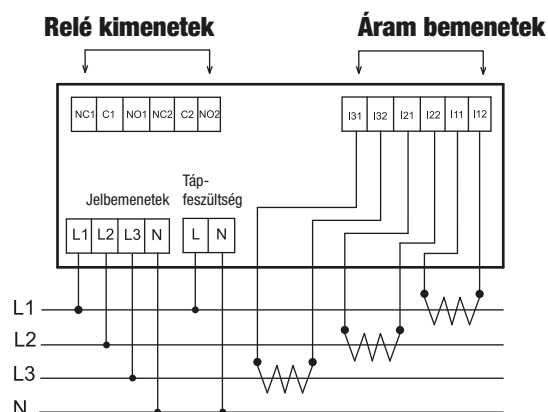

Jelölés	Mért mennyiség	Riasztás	Teljes	L1	L2	L3
V _{LN}	Fázisfeszültség (V)	✓	✓ (*)	✓	✓	✓
V _{LL}	Vonali feszültség (V)	✓	✓ (*)	✓	✓	✓
I	Fázisáram (A)	✓	✓	✓	✓	✓
FRQ	Frekvencia (Hz)	-	-	✓	-	-
PF	Teljesítménytényező (cos φ)	-	✓ (*)	✓	✓	✓
kW	Hatásos teljesítmény (kW)	✓	✓	✓	✓	✓
kVAr	Meddő teljesítmény (kVAr)	✓	✓	✓	✓	✓
kVA	Látszólagos teljesítmény (kVA)	✓	✓	✓	✓	✓
kWh	Hatásos energia (kWh)	-	✓	-	-	-
kVArh.IND	Induktív meddő energia (kVArh)	-	✓	-	-	-
kVArh.CAP	Kapacitív meddő energia (kVArh)	-	✓	-	-	-
kVAh	Látszólagos energia (kVAh)	-	✓	-	-	-
V _{THD}	Teljes feszültség harmonikus torzítási tényező (%)	-	-	✓	✓	✓
V _{3 ... V₁₃}	Páratlan feszültség harmonikusok (13.-ig) (%)	-	-	✓	✓	✓
I _{THD}	Teljes áram harmonikus torzítási tényező (%)	-	-	✓	✓	✓
I _{3 ... I₁₃}	Páratlan áram harmonikusok (13.-ig) (%)	-	-	✓	✓	✓

* A műszer ezen mennyiségek három fázison mért értékeinek átlagértékét jelzi.

Közvetlen fogyasztásmérők

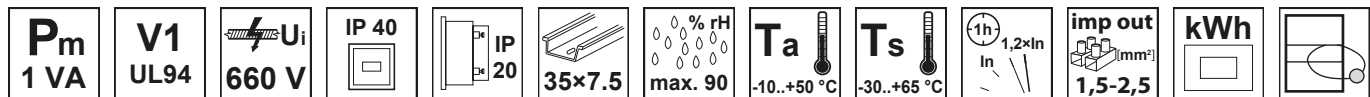

TRACON			U_n	I_b (I _{max})		imp/kWh S0		mm ²		
TVOF11	DIRECT → kWh		230 V AC	5 (40) A	20 mA – 40 A	2.000	1	10	6	84 g
TVOF12	DIRECT → kWh		230 V AC	10 (60) A	40 mA – 60 A	500	1	25	16	157 g
TVOF14	DIRECT → kWh		230 V AC	10 (100) A	40 mA – 100 A	1.600	1	50	35	236 g
TVOF1M4	DIRECT → kWh		230 V AC	10 (100) A	40 mA – 100 A	1.600	1	50	35	284 g
TVOF37	DIRECT → kWh		3×230/400 V AC	10 (100) A	40 mA – 100 A	400	1	50	35	455 g
TVOF3M7	DIRECT → kWh		3×230/400 V AC	10 (100) A	40 mA – 100 A	400	1	50	35	472 g



TVOF11

TVOF12

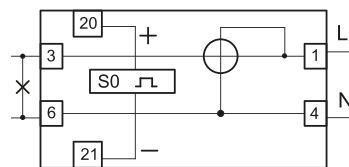

TVOF11, TVOF12

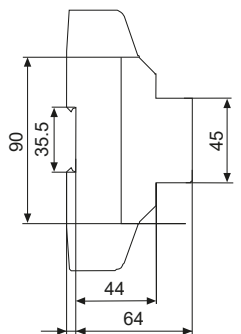
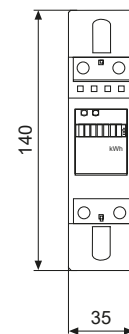

TVOF1M4

TVOF14

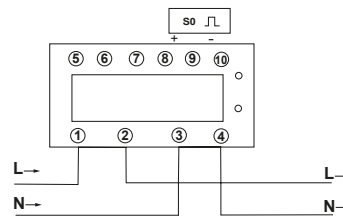

TVOF1M4, TVOF14

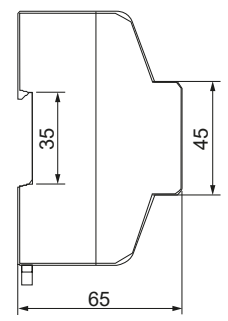
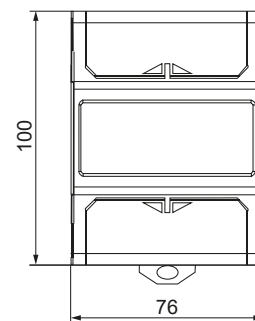

TVOF3M7

TVOF37

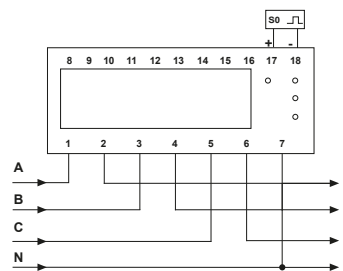

TVOF37, TVOF3M7

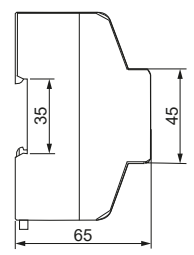
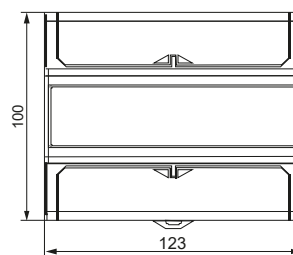

imp/kWh S0	U_n	L_{imp} 	I_n
	min. 12 V, max. 27 V	>30 ms	max. 27 mA

RELEVANT STANDARD
EN 62053

RELEVANT STANDARD
IEC 61036

Áramváltós fogyasztásmérő, 1 fázisú

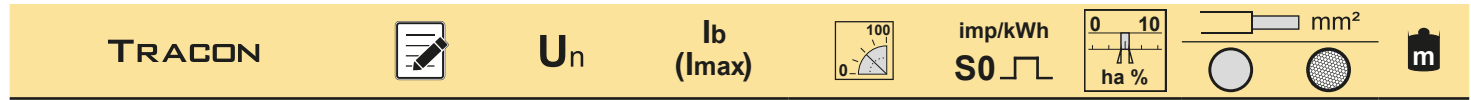
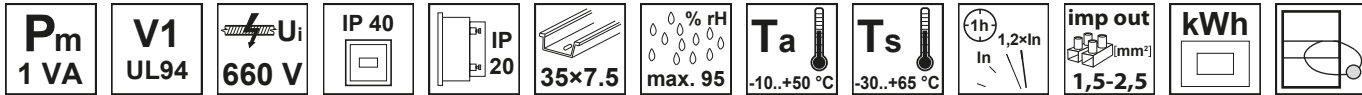

TV0-F1-CT CT kWh 220-240 V AC 5A/CT 0,002lp-lp 6.400 1 16 10 260 g

Ip – áramváltó primer árama
CT – áramváltó

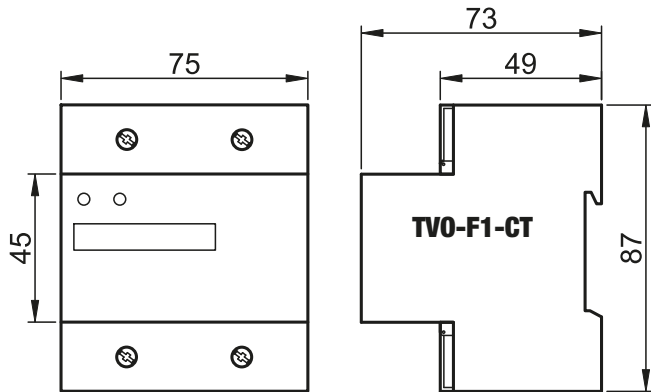

RELEVANT STANDARD
IEC 61036

RELEVANT STANDARD
EN 62053

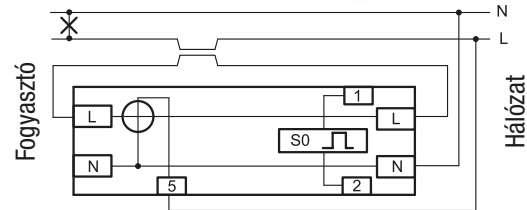
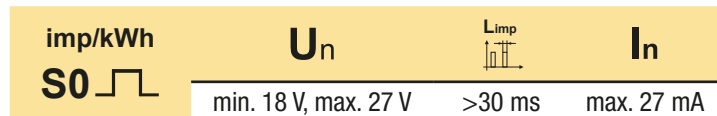

Átfűzős fogyasztásmérő, 1 fázisú

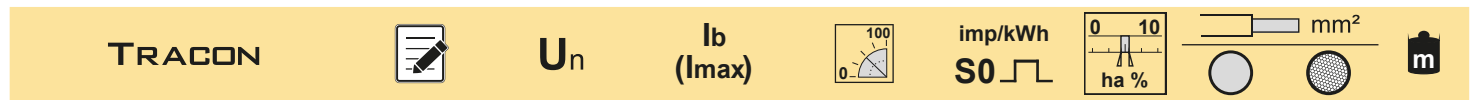
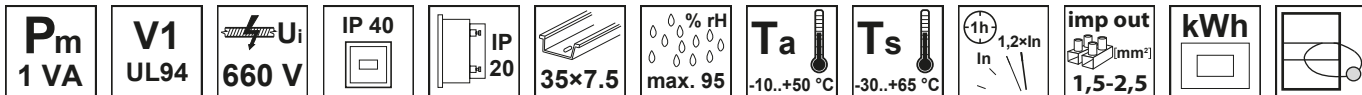

TV0-F1-WT DIRECT kWh 220-240 V AC 30 (100) A 80 mA-100 A 800 1 25 16 200 g

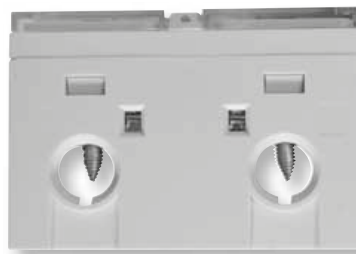
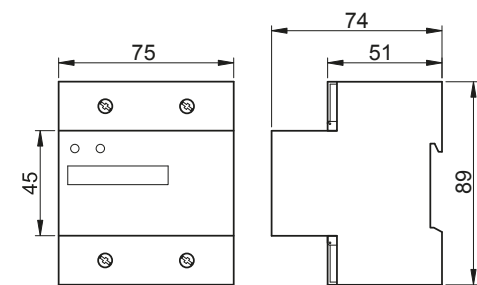

A vezetékét át kell vezetni az ablakon, ezután a csavar behajtásával a szigetelés átvágásával jön létre a kontaktus. A vékonyabb keresztmetszetű vezetékekhez egy szűkítő gyűrű van mellékelve.

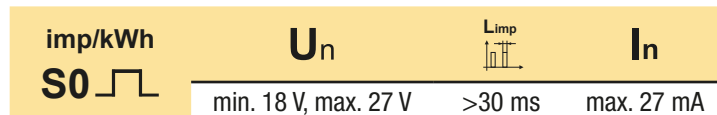
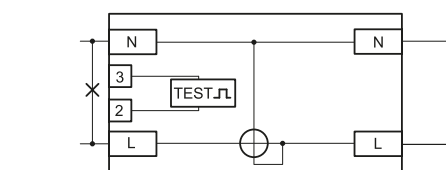

RELEVANT STANDARD
IEC 61036



4 modulós fogyasztásmérők, 3 fázisú

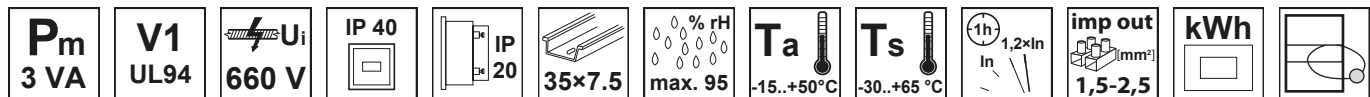

TRACON	U_n	I_b (I_{max})		imp/kWh S0		mm^2	
TV0-F3-4MCT CT kWh	3×230/400 V	5A/CT	0,002lp-lp	1.600	1	16 10	370 g
TV0-F3-4M DIRECT kWh	3×230/400 V	10 (100) A*	80 mA-100 A	400	2	25 16	450 g

* fázisonként

I_p – áramváltó primer árama
CT – áramváltó

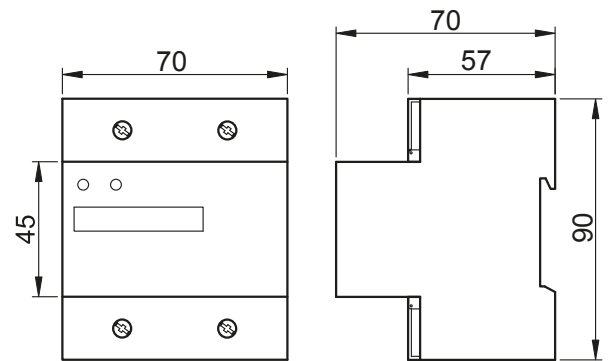

TV0-F3-4MCT

TV0-F3-4M

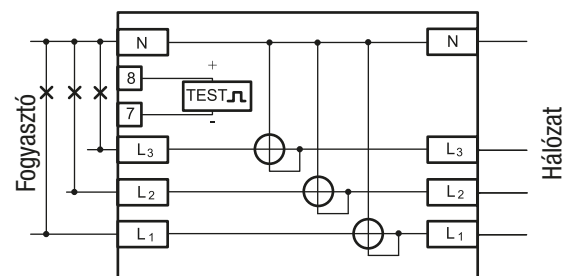
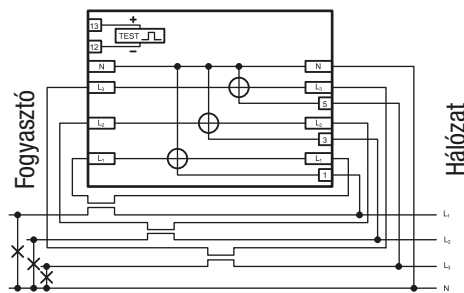

RELEVANT STANDARD
IEC 61036

RELEVANT STANDARD
EN 62053

imp/kWh
S0

U_n
min. 18 V, max. 27 V

L_{imp}

I_n
>30 ms max. 27 mA

Dugaszolható digitális fogyasztásmérő

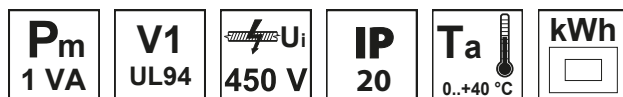

TRACON	U_n	I_n		P_{max}		
TV0-1D216F DIRECT kWh	230 V AC	16 A	2	3.600 W	3×357 A	200 g

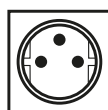

A TV0-1D216.. egy megbízható fogyasztásmérő, mely LCD kijelzőjén megjeleníti a kimeneti aljzatába csatlakoztatott háztartási vagy irodai készülék fogyasztását kilowattóraban, valamint a fogyasztott villamos energia költségét.



- Túlterhelés-riasztás (figyelmeztető jelzés)
- Maximum áram- és teljesítményérték-kijelzés
- A villamos energia használatának időtartama
- Óra
- Energiaköltség-számítás

RELEVANT STANDARD
EN 62053

Fázisjavító automatika, 3 fázisú fázisonkénti szabályzással

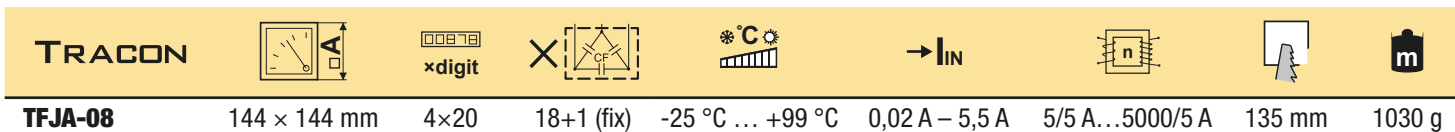
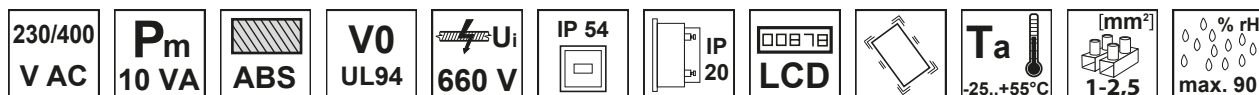

RELEVANT STANDARD
EN 6051

RELEVANT STANDARD
EN 61010

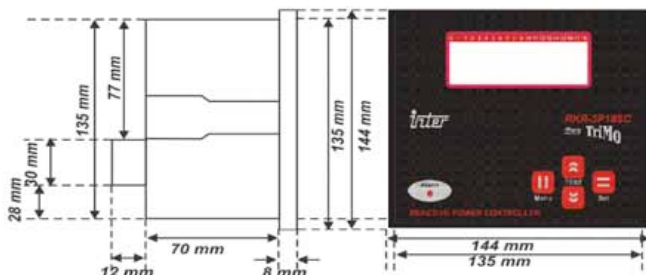

Olyan Hi-Tech mikroprocesszor alapú teljesítmény-szabályzók, melyek digitális LCD kijelzővel rendelkeznek és 7 vagy 12 db kondenzátortelep működtetését végzik. Ezek a szabályzók mindhárom fázisban mérik a hálózat paramétereit és eszerint történik a beavatkozás. Automata üzemmódban a fokozatok bekapcsolt állapotáról, a teljes teljesítménytényező értékéről és jellegéről kaphatunk tájékoztatást. Kézi üzemmódban lehetőség van a fázisonkénti teljesítménytényező, mindhárom fázis áramának és feszültségének ill. ezek felharmonikus tartalmának mérésére; hálózat hatásos, kapacitív- és induktív meddő energiájának mérésére és kijelzésére, valamint az egyes fokozatok felhasználó általi be- és kikapcsolására is. A szabályzó automata üzemmódban a kondenzátortelepek be- és kikapcsolását a szükséges kondenzátorteljesítmény és a beállított paraméterek alapján végzi. A szabályozási folyamat egy komplex algoritmus alapján kapcsolja be és ki az egyes fokozatokat a beállított kívánt teljesítménytényező értéke és jellege alapján, a kondenzátortelepek és ezeket kapcsoló kontaktorok élettartamának maximális megőrzése mellett. A készülék rendelkezik egy potenciálfüggetlen riasztáskimenettel, mely az előlapon található gombok segítségével programozható.

Fő funkciók

- LCD kijelző 4 soros, soronként 20 karakter
- Kézi / Automatikus üzemmód
- Beállítási tartomány: $\cos\phi$ 0,8 ind-0,8 cap
- Állítható túlmelegedés védelem
- Állítható felharmonikus védelem
- Feszültség és árammérés a 21-dik felharmonikusig
- Riasztások, riasztási kimenettel
- 3 fázisú fázisonkénti szabályozás
- Automatikus terhelési jelleg felismerés
- Késleltetett Be / Ki kapcsolás
- Állítható túlfeszültség védelem
- Teljes felharmonikus kijelzés
- Feszültség, áram és teljesítmények kijelzése
- Jelszavas védelem

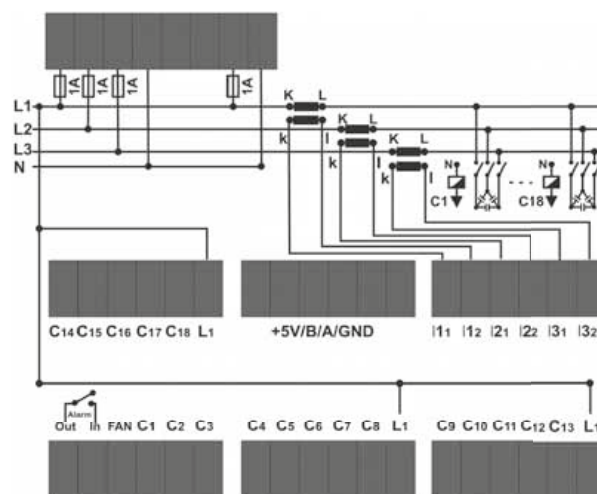

USB-485 átalakító TFJA-08-hoz

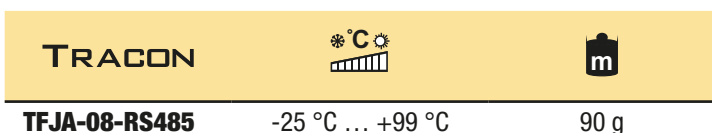
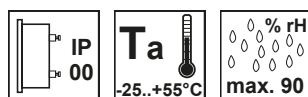

Egyfázisban mérő meddőteljesítmény-szabályozók

230 V AC	ABS	V0 UL94	U_i 660 V	IP 54	IP 20	LCD	Ta -25...+55°C	[mm ²] 1-2,5	Piktogramok	L/O
-------------	-----	------------	----------------	-------	-------	-----	-------------------	-----------------------------	-------------	-----

TRACON								
TFJA-01	144 × 144 mm	2×16	7+1 (fix)	-25 °C ... +99 °C	0,02 A – 5,5 A	5/5 A...5000/5 A	135 mm	1000 g
TFJA-02	144 × 144 mm	2×16	12+1 (fix)	-25 °C ... +99 °C	0,02 A – 5,5 A	5/5 A...5000/5 A	135 mm	1050 g



RELEVANT STANDARD
EN 60051

RELEVANT STANDARD
EN 61010

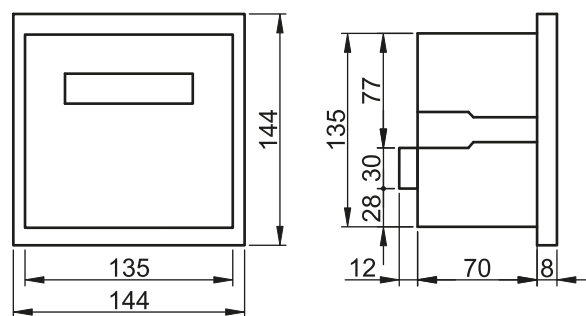

Olyan Hi-Tech mikroprocesszor alapú teljesítmény-szabályozók, melyek digitális LCD kijelzővel rendelkeznek és 7 vagy 12 db kondenzátortelep kezelését végzik. Ezek a szabályozók csak egy fázisban mérik a hálózat paramétereit és eszerint történik a beavatkozás. A teljesítménytényező és jellege, a fázisfeszültség- és áram, a feszültség harmonikusok mellett a kondenzátorok hőmérséklete és a bekapcsolt fokozatok száma is megjeleníthető a kijelzőn. Kézi üzemmódban lehetőség van az egyes fokozatok felhasználó általi vezérlésére. A tesztelési folyamat során a csatlakoztatott fokozatokat és az ezekre eső meddő teljesítményt automatikusan határozzák meg. A szabályzó automatikus üzemmódban a kondenzátortelemek be- és kikapcsolását a szükséges kondenzátorteljesítmény és a beállított paraméterek alapján végzi. A szabályozási folyamat egy komplex algoritmus alapján kapcsolja be és ki az egyes fokozatokat a beállított kívánt teljesítménytényező értéke és jellege alapján, a kondenzátortelemek és az ezeket kapcsoló kontaktorok élettartamának maximális megőrzése mellett. A készülék rendelkezik egy potenciálfüggetlen riasztáskimenettel, mely az előlapon található gombok segítségével programozható. A hűtés kimenet a telepek hőmérsékletemelkedésekor válik aktívvá a beállított és a készülék memóriájában tárolt határérték szerint. A riasztáskimenet aktív állapotát az előlapon elhelyezett LED fényjelzése mutatja.

Fő funkciók

- állítható teljesítménytényező érték 0,8 induktív és 1,0 kapacitív között;
- automata és kézi üzemmód;
- pontos kezdeti kondenzátorteljesítmény-meghatározás;
- automatikus áramhatárérték (C/k) beállítás;
- automatikus polaritásfelismerés az áramváltó csatlakozókapcsain;
- állítható feszültségnövekedési- és túlmelegedésvédelmi határ;
- riasztás alul- és túlkompenzálás esetén;
- riasztás áramhiány ill. magas feszültség felharmonikus tartomány esetén;
- állítható kondenzátor ki- és bekapcsolási idő;
- teljesítménytényező, fázisfeszültség- és áram, frekvencia, hőmérséklet, feszültségfelharmonikus tartomány mérése, ellenőrzése és kijelzése;
- a hiba jellege és a bekapcsolt fokozatok száma a készülék kijelzőjén jeleníthetők meg.

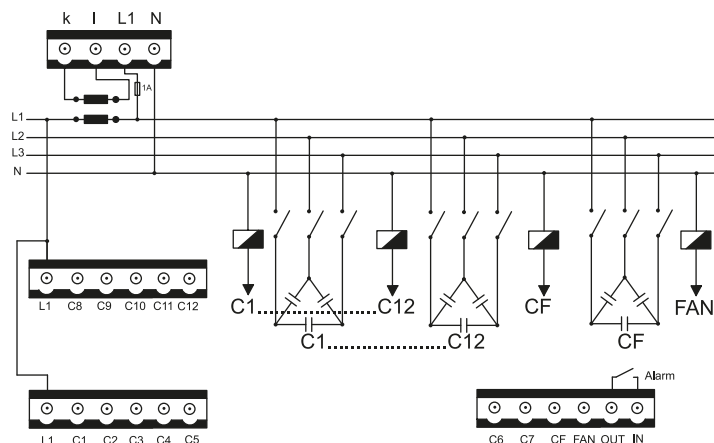

Három fázisban mérő meddőteljesítmény-szabályzók

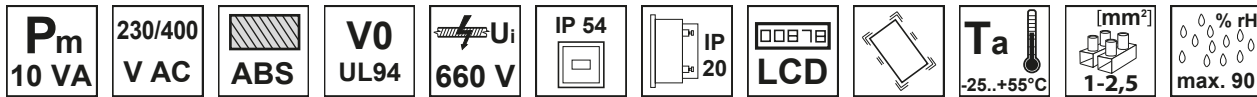

TRACON								
TFJA-03	144 × 144 mm	2×16	7+1 (fix)	-25 °C ... +99 °C	0,02 A – 5,5 A	5/5 A...5000/5 A	135 mm	1030 g
TFJA-04	144 × 144 mm	2×16	12+1 (fix)	-25 °C ... +99 °C	0,02 A – 5,5 A	5/5 A...5000/5 A	135 mm	1030 g

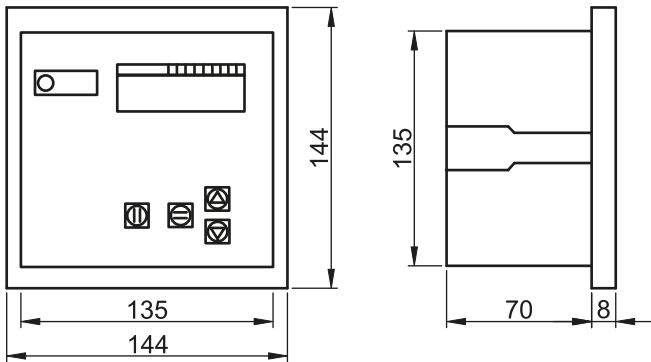

RELEVANT STANDARD
EN 60051

RELEVANT STANDARD
EN 61010



Olyan Hi-Tech mikroprocesszor alapú teljesítmény-szabályzók, melyek digitális LCD kijelzővel rendelkeznek és 7 vagy 12 db kondenzátortelep működtetését végzik. Ezek a szabályzók mindhárom fázisban mérik a hálózat paramétereit és eszerint történik a beavatkozás. Automata üzemmódban a fokozatok bekapcsolt állapotáról, a teljes teljesítménytényező értékéről és jellegéről kaphatunk tájékoztatást. Kézi üzemmódban lehetőség van a fázisonkénti teljesítménytényező, mindhárom fázis áramának és feszültségének ill. ezek felharmonikus tartalmának mérésére; hálózat hatásos, kapacitív- és induktív meddő energiájának mérésére és kijelzésére, valamint az egyes fokozatok felhasználó általi be- és kikapcsolására is. A szabályzó automata üzemmódban a kondenzátortelemek be- és kikapcsolását a szükséges kondenzátorteljesítmény és a beállított paraméterek alapján végzi. A szabályozási folyamat egy komplex algoritmus alapján kapcsolja be és ki az egyes fokozatokat a beállított kívánt teljesítménytényező értéke és jellege alapján, a kondenzátortelemek és ezeket kapcsoló kontaktorok élettartamának maximális megőrzése mellett. A készülék rendelkezik egy potenciálfüggetlen riasztáskimenettel, mely az előlapon található gombok segítségével programozható. A hűtés kimenet a telepek hőmérséklet emelkedésekor válik aktívvá a beállított és a készülék memóriájában tárolt határérték szerint. A riasztáskimenet aktív állapotát az előlapon elhelyezett LED fényjelzése mutatja.

Fő funkciók

- állítható teljesítménytényező tartomány határértékei 0,8 induktív és 0,9 kapacitív között;
- automata és kézi üzemmód;
- egymástól függetlenül paraméterezhető fokozatonkénti kondenzátorteljesítmény;
- automatikus áramérzékelés;
- állítható feszültségnövekedési és túlmelegedési határ;
- állítható magas felharmonikus határ;
- állítható kondenzátorkapcsolási késleltetés;
- állítható felharmonikus feszültségvédelmi szint (V_{THD} ; V_3 ; $V_5 \dots V_{13}$);
- állítható felharmonikus áramvédelmi szint (I_{THD} ; I_3 ; $I_5 \dots I_{13}$);
- kondenzátor teszt mód;

- hatásos; induktív; kapacitív fogyasztásmérés;
- fázisáram, fázis- és vonali feszültség, fázisonkénti teljesítmény- és teljes harmonikus torzítási tényező mérés és ellenőrzés;
- kondenzátorteljesítmény; hőmérséklet; frekvencia; teljes teljesítménytényező mérés és ellenőrzés;
- riasztás alul- és túlkompenzálás, feszültségnövekedés, hőmérséklet emelkedés, magas meddő- és hatásos energiaarány, magas felharmonikus tartalom esetén, késleltetéssel.

C/k áramhatárérték beállítás: automatikus, kézi
 Áramváltó polarizálás: automatikus
 A/D átalakító: 10 bit
 Mintavételi gyakoriság: 64 minta/periódus
 Érintkező/riasztás kimenet: 250 V/5 A AC

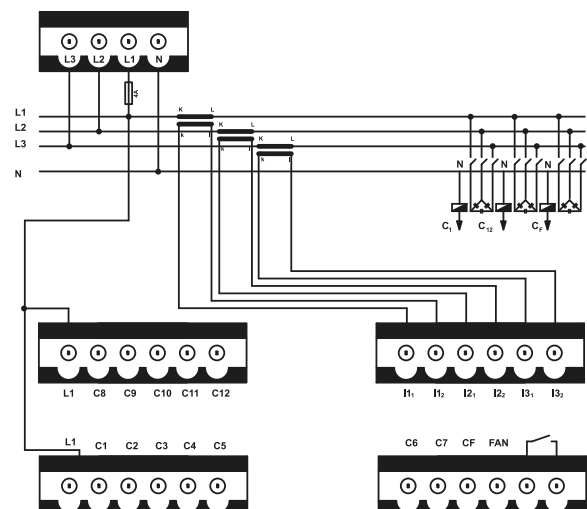

Automatikus vagy kézi működésű meddőteljesítmény-szabályzók



TRACON								
TFJA-05	144 × 144 mm	3×7	5+1 (fix)	-25 °C ... +99 °C	0,02 A – 5,5 A	5/5 A...5000/5 A	92 mm	1000 g
TFJA-06	96 × 96 mm	3×7	7+1 (fix)	-25 °C ... +99 °C	0,02 A – 5,5 A	5/5 A...5000/5 A	135 mm	600 g

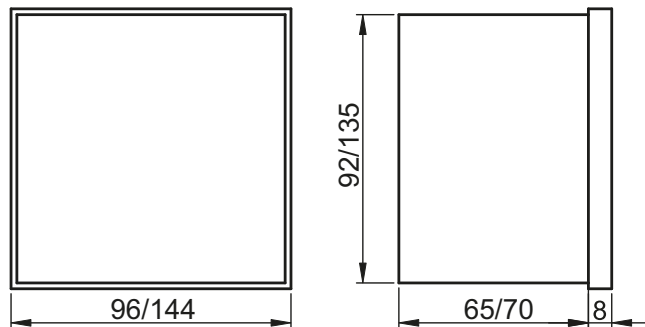

Ezek a készülékek olyan mikroprocesszor alapú szabályzók, amelyek LED kijelzővel rendelkeznek és 5, illetve 7 kondenzátorcsoport vezérlésére alkalmasak. Csak egy fázisban mérik a hálózat paramétereit és eszerint történik a beavatkozás.

A kondenzátorok ki ill. bekapcsolásának végrehajtása összhangban van a már korábban meghatározott teljes meddő teljesítménnyel és a mért kondenzátorteljesítményekkel. Kézi üzemmódban lehetőség van az egyes fokozatok felhasználó általi be- és kikapcsolására.

A szabályzók egy komplex kondenzátor mérési és teljesítmény meghatározási algoritmus alapján kapcsolják az egyes fokozatokat a beállított kívánt teljesítménytényező értéke és jellege alapján, a kondenzátortelemek és az ezeket kapcsoló kontaktorok élettartamának maximális megőrzése mellett. A készülék rendelkezik egy potenciálfüggetlen riasztáskimenettel, mely az előlapon található nyomógombok segítségével állítható be. A riasztáskimenet és az egyes fokozatok bekapcsolt állapotát, a szabályzó üzemmódját, a kijelzett mennyiséget és a terhelés jellegét az előlapon elhelyezett LED-ek fényjelzése mutatja.

Fő funkciók

- állítható teljesítménytényező érték 0,8 és 1,0 között;
- Automata és kézi üzemmód;
- Kondenzátor teljesítménymérés;
- Automata C/k áramhatárérték-beállítás;
- Automata áramirány-meghatározás;
- Állítható kondenzátor ki/be kapcsolási idő;
- Fázisfeszültség és teljesítménytényező értékeinek megjelenítése;
- Hibakijelzés Led indikátorok segítségével a kijelzőn.

C/k áramhatárérték beállítás:	automatikus
Áramváltó polarizálás:	automatikus
Érintkező kimenet terhelhetősége:	250 V/5 A AC (TFJA-05), 250 V/3 A AC (TFJA-06)
Riasztás kimenet terhelhetősége:	250 V/5 A AC (TFJA-05), 250 V/3 A AC (TFJA-06)

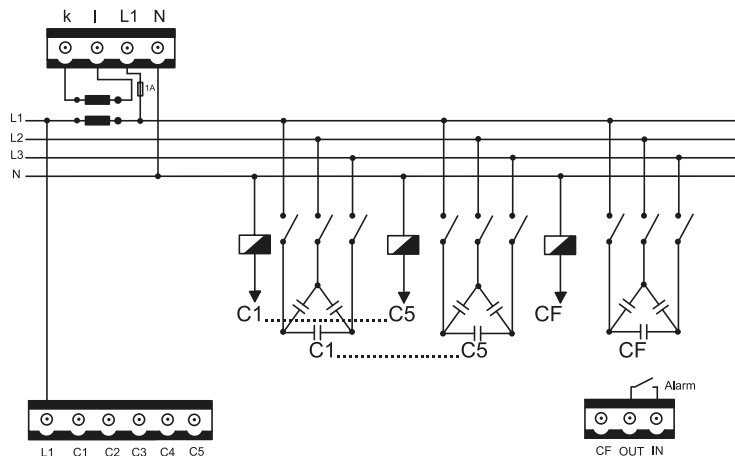

RELEVANT STANDARD
EN 60051

RELEVANT STANDARD
EN 61010



OLVASSA BE A KÓDOT!

- Nézze meg újdonságainkat
- Legyen naprakész

Kínálatunk gyorsan és folyamatosan fejlődik!
Katalógusunk a 2021. áprilisi állapotot tükrözi.
Naprakész információért látogasson el honlapunkra!

Automatikus működésű meddőteljesítmény-szabályzók

230 V AC	ABS	V0 UL94	U_i 660 V	IP 30	IP 20	LCD	T_a -25...+55°C	[mm ²] 1-2,5	Piktogramok L/O
-------------	-----	------------	----------------	-------	-------	-----	----------------------	-----------------------------	-----------------

TRACON		xdigit					
TFJA-07	144 × 144 mm	3×7	5	-25 °C ... +99 °C	5/5 A...5000/5 A	1 %	135 mm 1.200 g

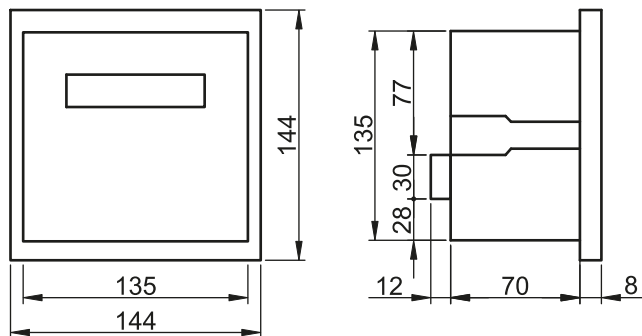

A TFJA-07 típusú meddőteljesítmény-szabályzó készülék teljesen automatikus működésű és nem tartalmaz beállító gombokat a panelen. Az egy fázisban mért fázisfeszültség és áram alapján történik a beavatkozás. A készülék az öt kondenzátortelepet a mikroprocesszor alapú szabályzási algoritmus alapján kapcsolja a hálózatra, ha a teljesítménytényező értéke 0,95 alá csökken. A kondenzátor telepek bekapcsolása 14 másodperces, a kikapcsolásuk pedig 5 másodperces időkésleltetéssel történik. Terhelésmentes állapotban vagy minimumterhelésnél, ahol a $\cos \varphi$ értéke a 0,95 - 1 tartományon kívül esik, az első kondenzátor fokozat joker kondenzátorként fog működni. A legkisebb kondenzátorteljesítményű kondenzátortelepet kell az 1. fokozathoz csatlakoztatni. A teljesítménytényező értéke az előlapon található 3 digitális LED kijelzőről olvasható le. A bekapcsolt fokozatok számáról ill. a teljesítménytényező induktív/kapacitív jellegéről az előlapon elhelyezett LED indikátorok adnak tájékoztatást. A kondenzátorteljesítménynek az egyes fokozatokra történő elosztása az alábbi táblázat alapján végezhető el.

Kondenzátorkimenetek	1. fokozat	2. fokozat	3. fokozat	4. fokozat	5. fokozat
Kondenzátorteljesítmény	1 -1,5 kVAr	2,5 kVAr	5 kVAr	10 kVAr	20 kVAr

Feszültségmérő bemenet: L1, N
 Mintavételi gyakoriság: 64 minta / periódus
 Árammérő bemenet: k, I
 Árammérő bemeneti terhelése: max. 7 A állandó, 20 A / 1 sec.
 Érintkező kimenet terhelhetősége: 250 V/5 A AC

RELEVANT STANDARD
EN 60051

RELEVANT STANDARD
EN 61010

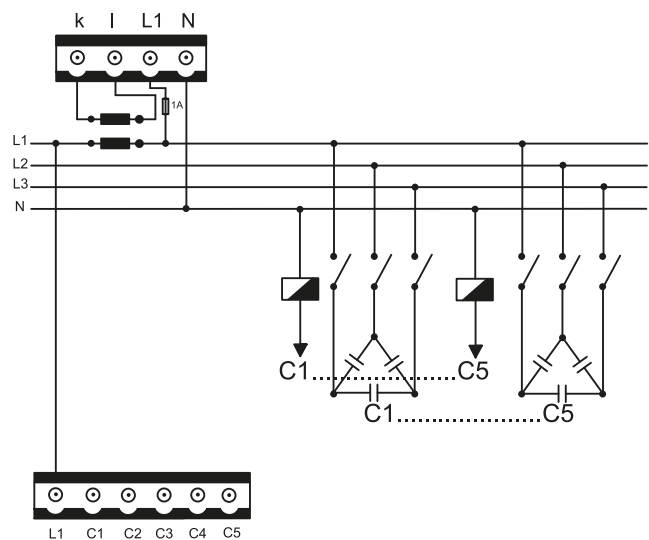

Kisfeszültségű áramváltók

Használatukkal analóg ill. digitális váltakozó áramú árammérők mérés-határa bővíthető ki 5-3000 A áramtartományban, de segítségükkel az áramváltók szekunder kapcsaihoz csatlakoztatott teljesítménytényező-mérők, fogyasztásmérők, hálózati analizátorok, multiméterek, meddőteljesítmény-szabályozók áramtekercseinek mérés-határa is növelhető.

Az áramváltók egy primer tekercsből, egy szekunder tekercsből valamint egy ferromágneses vasmagból állnak. A primer tekercs vagy egy tekercs az áramváltó házban, vagy az áramváltón átfűzött kábel vagy sín. Beépített primer tekercs illetőleg kábel átfűzése esetén az áramváltót a készülékhez mellékelt rögzítő készlet segítségével külön rögzíteni kell. A beépített primer sinnel rendelkező kivitelek esetén a rögzítés közvetlenül a sinen történik.

Az áramváltó primer tekercsének P1 oldala csatlakozik a hálózathoz, a P2 oldala pedig a fogyasztóhoz. A szekunder tekercs S1 és S2 kapcsai közvetlenül a műszer megfelelő bemenetéhez csatlakoznak.

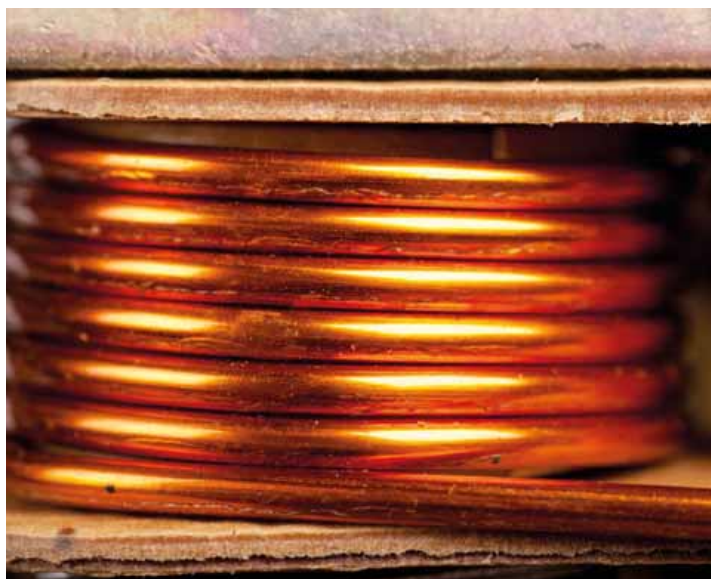

AVBS (5/5A-150/5A)

660 V AC	V0 UL94	U _i 720 V	3 kV	U _{test} 1min 3 kV	F _s security 5	1,2×I _n	T _a -5..+45 °C	I _{th} 50×I _n	I _{din} 2,5×I _{th}	Piktogramok	L/O
-------------	------------	-------------------------	------	-----------------------------------	---------------------------------	--------------------	------------------------------	--------------------------------------	---	-------------	-----

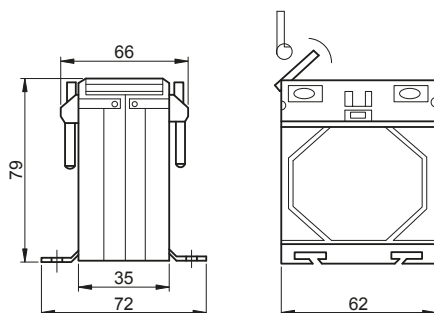

RELEVANT STANDARD
EN 61010

TRACON		P _s		
AVBS-5	5/5 A	2,5 VA	0,5	370 g
AVBS-15	15/5 A	2,5 VA	0,5	380 g
AVBS-30	30/5 A	2,5 VA	0,5	400 g
AVBS-50	50/5 A	2,5 VA	0,5	420 g
AVBS-60	60/5 A	2,5 VA	0,5	430 g
AVBS-75	75/5 A	2,5 VA	0,5	450 g
AVBS-100	100/5 A	2,5 VA	0,5	480 g
AVBS-150	150/5 A	2,5 VA	0,5	510 g

beépített primer sines kivitel

AV30..SH (50/5A-200/5A)

660 V AC	V0 UL94	U _i 720 V	3 kV	U _{test} 1min 3 kV	F _s security 5	1,2×I _n	T _a -5..+45 °C	I _{th} 100×I _n	I _{din} 2,5×I _{th}
-------------	------------	-------------------------	------	-----------------------------------	---------------------------------	--------------------	------------------------------	---------------------------------------	---

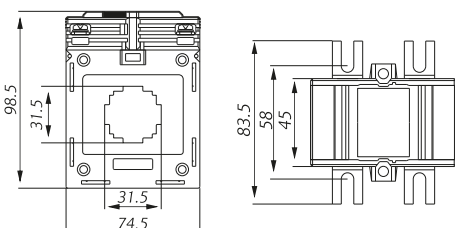

TRACON		P _s		
AV3060SH	60/5 A	1,5 VA	0,5	500 g
AV3075SH	75/5 A	2,5 VA	0,5	500 g
AV30100SH	100/5 A	3,75 VA	0,5	500 g
AV30150SH	150/5 A	5 VA	0,5	500 g
AV30200SH	200/5 A	5 VA	0,5	500 g

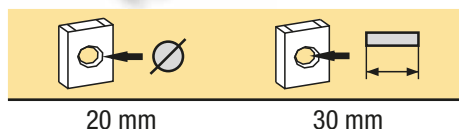

RELEVANT STANDARD
EN 60051

RELEVANT STANDARD
EN 61010

AV40..SH (100/5A-500/5A)

660 V AC	V0 UL94	U _i 720 V		U _{test} 1min 3 kV	F _s security 5	1,2×I _n I _n	T _a -5...+45 °C	I _{th} 50×I _n	I _{din} 2,5×I _{th}	Piktogramok	L/O
-------------	------------	-------------------------	--	-----------------------------------	---------------------------------	--------------------------------------	-------------------------------	--------------------------------------	---	-------------	-----

TRACON		P _s		
AV40100SH	100/5 A	2,5 VA	0,5	500 g
AV40150SH	150/5 A	5 VA	0,5	500 g
AV40200SH	200/5 A	5 VA	0,5	500 g
AV40250SH	250/5 A	5 VA	0,5	500 g
AV40300SH	300/5 A	5 VA	0,5	500 g
AV40400SH	400/5 A	5 VA	0,5	500 g
AV40500SH	500/5 A	5 VA	0,5	500 g

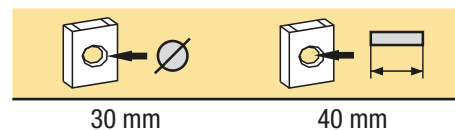
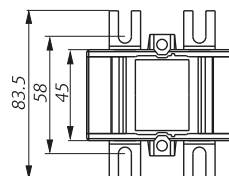
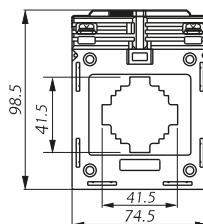

AV60..SH (600/5A-1200/5A)

660 V AC	V0 UL94	U _i 720 V		U _{test} 1min 3 kV	F _s security 5	1,2×I _n I _n	T _a -5...+45 °C	I _{th} max. 50kA _{eff}	I _{din} 2,5×I _{th}
-------------	------------	-------------------------	--	-----------------------------------	---------------------------------	--------------------------------------	-------------------------------	---	---

TRACON		P _s		
AV60600SH	600/5 A	15 VA	0,5	450 g
AV60800SH	800/5 A	15 VA	0,5	480 g
AV601000SH	1000/5 A	15 VA	0,5	520 g
AV601200SH	1200/5 A	15 VA	0,5	520 g

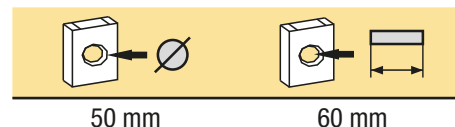
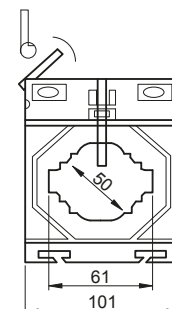
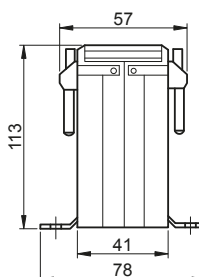

RELEVANT STANDARD
EN 60051

RELEVANT STANDARD
EN 61010

AV100..SH (1200/5A-3000/5A)

660 V AC	V0 UL94	U _i 720 V		U _{test} 1min 3 kV	F _s security 5	1,2×I _n I _n	T _a -5...+45 °C	I _{th} max. 50kA _{eff}	I _{din} 2,5×I _{th}
-------------	------------	-------------------------	--	-----------------------------------	---------------------------------	--------------------------------------	-------------------------------	---	---

TRACON		P _s		
AV1001200SH	1200/5 A	15 VA	0,5	690 g
AV1001600SH	1600/5 A	15 VA	0,5	850 g
AV1002000SH	2000/5 A	15 VA	0,5	1.000 g
AV1002500SH	2500/5 A	15 VA	0,5	1.050 g
AV1003000SH	3000/5 A	15 VA	0,5	1.200 g

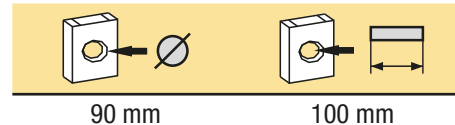
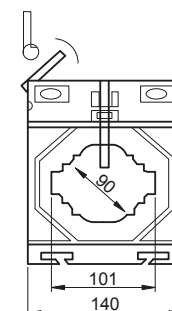
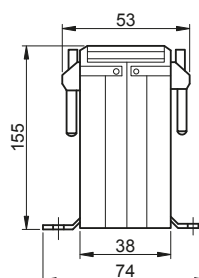

RELEVANT STANDARD
EN 60051

RELEVANT STANDARD
EN 61010

Hitelesíthető áramváltók

Ezek az áramváltók megfelelnek az EN 60044-1 szabvány előírásainak és kielégítik a 0,5S osztálypontosság követelményeit.

A nemzeti hitelesítő hatóságokkal egyedileg hitelesítettnek kell ezeket az áramváltókat abban az esetben, ha hitelesített elszámolási (tarifális) mérés céljára kívánják használni.

Mivel az áramváltók MKEH-MH (volt OMH) hitelesítéssel rendelkeznek, ezért tarifális jellegű, hitelesített elszámolási mérésre is használhatók.

Erre való tekintettel beépítését az Áramszolgáltató Vállalatok is elfogadják.

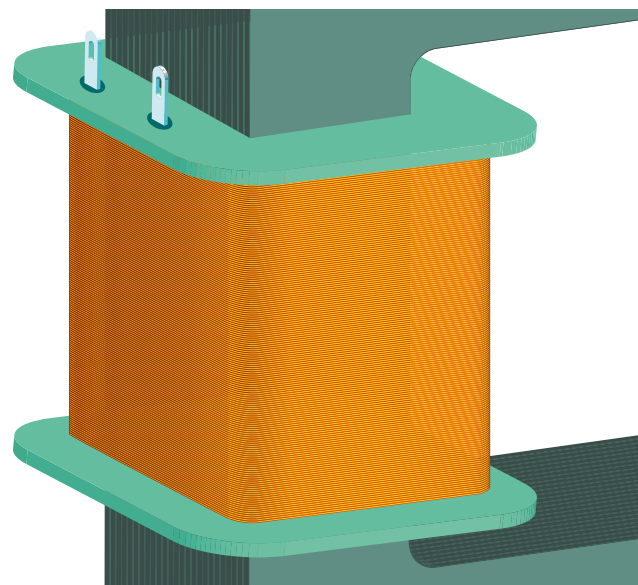

RELEVANT STANDARD
EN 60051

RELEVANT STANDARD
EN 61010

EPSA30 (150/5A-400/5A) 1,5 VA

660 V AC	MKEH -MH	U_i 720 V		Utest 1min 3 kV	Fs security 5	$1,2 \times I_n$ In	Ta -5...+45 °C	I _{th} 60×I _n	I _{din} 2,5×I _{th}	Piktogramok	L/O
-------------	-------------	----------------	--	-----------------------	---------------------	------------------------	-------------------	--------------------------------------	---	-------------	-----

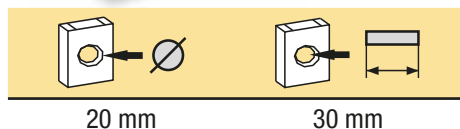
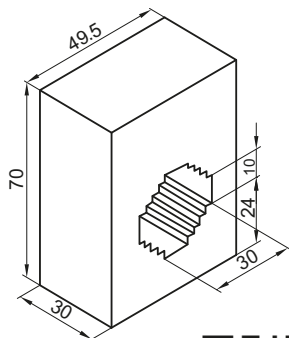

TRACON		P _s		
EPSA30150-1,5	150/5 A	1,5 VA	0,5S	300 g
EPSA30200-1,5	200/5 A	1,5 VA	0,5S	300 g
EPSA30250-1,5	250/5 A	1,5 VA	0,5S	300 g
EPSA30300-1,5	300/5 A	1,5 VA	0,5S	300 g
EPSA30400-1,5	400/5 A	1,5 VA	0,5S	300 g

RELEVANT STANDARD
EN 60051

RELEVANT STANDARD
EN 61010

EPSA30 (150/5A-500/5A) 2,5 VA

660 V AC	MKEH -MH	U_i 720 V		Utest 1min 3 kV	Fs security 5	$1,2 \times I_n$ In	Ta -5...+45 °C	I _{th} 60×I _n	I _{din} 2,5×I _{th}
-------------	-------------	----------------	--	-----------------------	---------------------	------------------------	-------------------	--------------------------------------	---

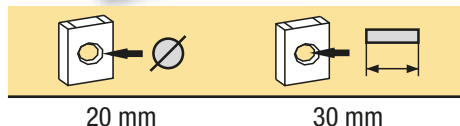
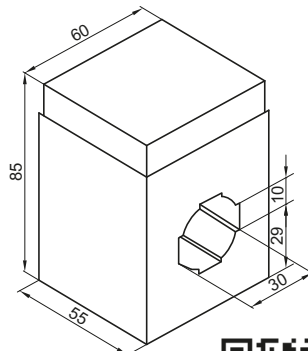

TRACON		P _s		
EPSA30150-2,5	150/5 A	2,5 VA	0,5S	300 g
EPSA30200-2,5	200/5 A	2,5 VA	0,5S	300 g
EPSA30250-2,5	250/5 A	2,5 VA	0,5S	300 g
EPSA30300-2,5	300/5 A	2,5 VA	0,5S	300 g
EPSA30400-2,5	400/5 A	2,5 VA	0,5S	300 g
EPSA30500-2,5	500/5 A	2,5 VA	0,5S	300 g

RELEVANT STANDARD
EN 60051

RELEVANT STANDARD
EN 61010

EPSA30 (150/5A-500/5A) 2,5 VA

660 V AC	MKEH -MH	U_i 720 V		U_{test} 1min 3 kV	F_s security 5	$1,2 \times I_n$	T_a -5...+45 °C	I_{th} 60× I_n	I_{din} 2,5× I_{th}	Piktogramok	L/0
-------------	-------------	----------------	--	----------------------------	------------------------	------------------	----------------------	-----------------------	----------------------------	--------------------	------------

TRACON		P_s	0 10 ha %	
EPSA30150-5	150/5 A	5 VA	0,5S	300 g
EPSA30200-5	200/5 A	5 VA	0,5S	300 g
EPSA30250-5	250/5 A	5 VA	0,5S	300 g
EPSA30300-5	300/5 A	5 VA	0,5S	300 g
EPSA30400-5	400/5 A	5 VA	0,5S	300 g
EPSA30500-5	500/5 A	5 VA	0,5S	300 g

RELEVANT STANDARD
EN 60051

RELEVANT STANDARD
EN 61010

Dimensions: 60 mm (width), 85 mm (height), 55 mm (depth). Mounting hole diameter: 20 mm. Mounting hole distance: 30 mm.

EPSA40 (250/5A-500/5A) 2,5-5 VA

660 V AC	MKEH -MH	U_i 720 V		U_{test} 1min 3 kV	F_s security 5	$1,2 \times I_n$	T_a -5...+45 °C	I_{th} 60× I_n	I_{din} 2,5× I_{th}
-------------	-------------	----------------	--	----------------------------	------------------------	------------------	----------------------	-----------------------	----------------------------

TRACON		P_s	0 10 ha %	
EPSA40250-2,5	250/5 A	2,5 VA	0,5S	300 g
EPSA40300-2,5	300/5 A	2,5 VA	0,5S	300 g
EPSA40400-2,5	400/5 A	2,5 VA	0,5S	300 g
EPSA40500-2,5	500/5 A	2,5 VA	0,5S	300 g
EPSA40250-5	250/5 A	5 VA	0,5S	300 g
EPSA40300-5	300/5 A	5 VA	0,5S	300 g
EPSA40400-5	400/5 A	5 VA	0,5S	300 g
EPSA40500-5	500/5 A	5 VA	0,5S	300 g

Dimensions: 85 mm (height), 35 mm (depth), 60 mm (width), 40 mm (mounting hole distance), 28 mm (mounting hole diameter), 12,5 mm (mounting hole offset).



HÁLÓZAT KAPCSOLÓÓRÁK

G/2

Digitális multiméter



TRACON	xdigit	V	I	Ω	batt	115×65×35 mm	170 g
A880L	× 3.5	±(2%+10d)	±(3%+5d)	±(2%+5d)	9 V, 6F22		



Háttérvilágítás



RELEVANT STANDARD
EN 61010

DC V test	200 mV, 2 V, 20 V, 200 V, 500 V
AC V test	200 V, 500 V
DC A test	200 μA, 2 mA, 20 mA, 200 mA, 10 A
Ω test	200 Ω, 2 kΩ, 20 kΩ, 200 kΩ, 20 MΩ
test	3 V / 1 mA
G	3 V / 50 Hz / 560 kΩ

Digitális lakatfogó adapter A880L műszerhez

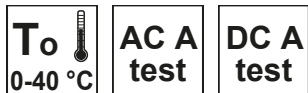

TRACON	I	batt	186×73×40 mm	350 g
EM264	±(2,5%+3d)	9 V, 1×6F22		



Az EM264 digitális lakatfogó adapter digitális multiméterek kiegészítője, melynek segítségével lehet AC/DC áramot mérni a vezeték megszakítása nélkül.

DC A test	40-400 A
AC A test	40-400 A
40 A	10 mV/A
400 A	1 mV/A

Digitális multiméter

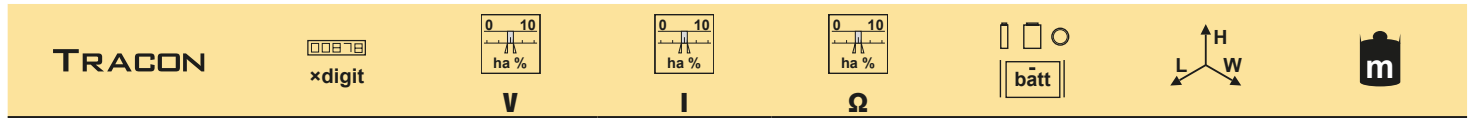
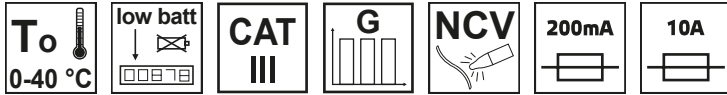

HK36A × 3,5 ±(2%+10d) ±(3%+5d) ±(1,5%+2d) 9 V, 6F22 150×75×50 mm 270 g

☀ Háttervilágítás

DC V test	200 mV, 2 V, 20 V, 200 V, 500 V
AC V test	200 V, 500 V
DC A test	200 μA, 2 mA, 20 mA, 200 mA, 10 A
Ω test	200 Ω, 2 kΩ, 20 kΩ, 200 kΩ, 20 MΩ
test	2,5 V / 1 mA
G	5 V / 50 Hz / 560 kΩ



RELEVANT STANDARD
EN 61010



Digitális lakatfogó

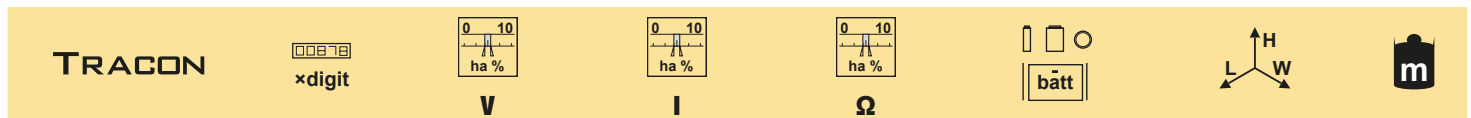
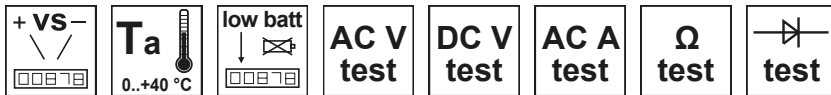

EM306B × 3,5 ±(1,5%+5d) ±(2,5%+5d) ±(2,0%+5d) 1,5 V, 3×AAA 132×61×25 mm 170 g

DC V test	600 V
AC V test	600 V
AC A test	20 - 200 A
Ω test	200Ω - 2kΩ - 20kΩ - 200kΩ - 2MΩ - 20MΩ
test	1,5 V; 0,6 mA



RELEVANT STANDARD
EN 61010



Gombok funkciói
HOLD

Pillanatnyi értéket tartja meg

Digitális lakatfogó



TRACON	xdigit	V	I	Ω	°C	batt	L H W	m
LF266	× 3,5	±(2%+5d)	±(2,5%+5d)	±(1,2%+5d)	-	9 V, 1×6LA61	240×90×40 mm	320 g



RELEVANT STANDARD
EN 61010

DC V test	1000 V
AC V test	750 V
AC A test	200-1000 A
Ω test	0,2-20 kΩ

Gombok funkciói
HOLD

Pillanatnyi értéket tartja meg

Vezeték követő

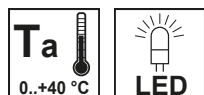

TRACON			L H W	m
EM422A	1,5 V, 2×AAA	3 V, 4×LR44	151×65×34 mm	127 g

A KÖVETŐ nem aktív vezetékek követésére szolgál. A készülék egy adóból és egy vevőből áll. Ideális körülmények között a követett vezeték 30 cm-es körzetében érzékel. Az eredmény nagyan függ különböző tényezőktől, pl. szigetelés, másik közeli vezetékek, stb.

ADÓ (Transmitter)

Az adó tartalmaz öt adaptert a vezetőhöz való csatlakozáshoz.

- RJ-11 csatlakozó
- Koax csatlakozó
- Két krokodilcsipesz
- Autóipari biztosító csatlakozó

Az adapterek az előlap alatt vannak.

Vevő (Receiver)

A vevő aktiválásához nyomja meg és tartsa lenyomva a **TEST** gombot, ekkor a vevő érzékeli az adó jelét. Mozgassa a vevőt az érzékelt vezeték közelébe. Ha a vezeték szakadásmentes, egy hangfrekvenciás hang hallható, és a **LED** fényereje megnő.

A **Sensitivity knob** gomb segítségével a műszer érzékenysége állítható.



OLVASSA BE A KÓDOT!



- Nézze meg újdonságainkat
- Legyen naprakész

Kínálatunk gyorsan és folyamatosan fejlődik!
Katalógusunk a 2021. áprilisi állapotot tükrözi.
Naprakész információért
látogasson el honlapunkra!

Gépjármű próbalámpa



Piktogramok
L/0

TRACON			
FV-06	-	118 × 11 × 11 mm	30 g
FV24	-	3 × 135 mm	45 g

DC V test	6-24 V
------------------	--------

RELEVANT STANDARD
EN 61010



FV-06



Működtetési idő: max. 10 másodperc





FV-24

Fáziskereső csavarhúzó



Piktogramok
L/0

TRACON			
FK	-	190 × 18,5 × 18,5 mm	28 g



AC V test	100-400 V
------------------	-----------



Feszültség ellenőrző indukciós készülék



Piktogramok
L/0



TRACON			
FV-01	-	130 × 18 × 15 mm	15 g





DC V test	12-36-55-110-230 V
------------------	--------------------

AC V test	12-36-55-110-230 V
------------------	--------------------













Lézeres távolságmérő



IP 54



























TRACON		D	λ			
LDM40	<1 mW	0.1-40 m	620 - 690 nm	2×AAA 1,5V	70 g	1.5 mm
LDM100	<1 mW	0.1-100 m	620 - 690 nm	2×AAA 1,5V	70 g	1.5 mm



Táblázat fejlécek piktogramjai

	Megjegyzés, kiegészítés		Fedélrögzítés: csavaros	In	Névleges áram (A)		Szín
	Fedél: átlátszó	IP..	Védettségi fokozat		Villamos szilárdság		Bemenet
	Szerelősín: perforált		Szerelősín: teli		Beköthető vezeték-keresztmetszet mm ²		Ø mm Beköthető vezeték
X 	Csavarok száma		Menet	xP 	Pólusszám	x17.5 	Modulok száma
	Tömör, sodrott, hajlékony vezeték	pcs 	Csomagolás		Sorolósín - Csapos kivitel		Sorolósín - Villás kivitel
X 	Kapcsok száma		Tömítési tartomány		Főkábel		Leágazó oldal
	Sín keresztmetszet mm ²		Maximális terhelhetőség		Ajánlott terhelhetőség		Sín méret (mm)
	Mechanikailag terhelhető nullavezető	CLICK 	Fedélrögzítés: pattintható		Fedél: teli		









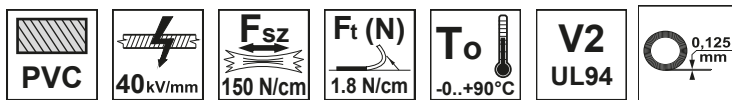

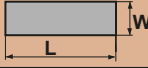

Műszaki adatok piktogramjai

230/400 V AC 	Névleges feszültség (V)		Névleges szigetelési feszültség 660 V		Anyag: ABS		Anyag: Poliamid 6.6
	Anyag: Polietilén		Anyag: Polipropilén		Anyag: Sárgaréz		Anyag: PVC
	Szerelősínre szerelhető 35x7.5	V0 UL94 	Lángállóság UL94 szerint	R 	Ellenállás 10 ¹⁴ Ωcm		Rézszín
Ft (N) 	Tapadóképesség 1.8 N/cm	ΔL 	Szakadási nyúlás 500 %	Fsz 	Szakítóerő, szakítószilárdság 150 N/cm		Villamos szilárdság 40 kV/mm
To 	Üzemi hőmérséklet -0..+90 °C	In max. 	Névleges áram (A) 100 A	IP 68 	Védettségi fokozat	Ta 	Környezeti hőmérséklet -10..+55 °C
	Gumidugóval		Anyag: Polisztirol	Silicon free 	Szilikon mentes		Zárópecsételhető
	Szín RAL 7035						Ütésállóság IK10

				
Szigetelőszalagok 2	Önvulkanizáló, szigetelő szalagok 3	Vászon szigetelő szalag 3	Ipari padlójelölő szalag 3	Maszkolószalag 4
				
Csúszást csökkentő jelölőszalag, sárga-fekete 4	PG tömítőszelencék 5	PG fémből készült tömítőszelencék 5	MG Metrikus tömítőszelencék 6	MG fémből készült metrikus tömítőszelencék 6
				
Metrikus tömítőszelence törésgátló kábelbevezetővel 7	Gégszőhöz illeszkedő kiegészítő gyorscsatlakozó 9	Tömítő szelencés kábeloldó 10	Vezetékjelölők 11	Sorolósín 125 A-ig 12
				
Szerelősín 13	Rézsintartó bakok 13	Rézsín (N/PE sín) 13	Szigetelt földelő sín 14	Falon kívüli kötődobozok 15
				
Elektronikai doboz 16	Műanyag doboz 17	Műanyag szerelődobozok 19	Falon kívüli rugalmas kötődobozok 19	Gipszkarton dobozok 19
				
Süllyesztett perforált kötődobozok 20	Süllyesztett perforált szerelvénydobozok 20	Dobozfedelek 21	Univerzális szerelvénydoboz 21	Doboztoldás utólagos szigeteléshez 21
				
Feszítő szerelvények 22	Függesztő szerelvények 22	Csavaros kötőelemek 23	LTT Légzeték-távtartó 23	TB Tetőtartó bevezető 23

Szigetelőszalagok



	 / TRACON			
	10 m x 15 mm	10 m x 18 mm	20 m x 18 mm	20 m x 50 mm
	B10-15	B10	B20	-
	FEH10-15	FEH10	FEH20	FEH50
	FEK10-15	FEK10	FEK20	FEK50
	K10-15	K10	K20	K50
	-	L10	L20	-
	-	N10	N20	-
	P10-15	P10	P20	P50
	S10-15	S10	S20	S50
	SZ10-15	SZ10	SZ20	SZ50
	Z10-15	Z10	Z20	Z50
	ZS10-15	ZS10	ZS20	ZS50





RELEVANT STANDARD
EN 60454

TÜV MEEI TEST DOCUMENTATION
28207724 001

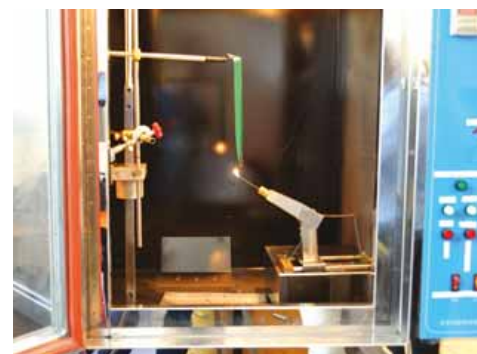
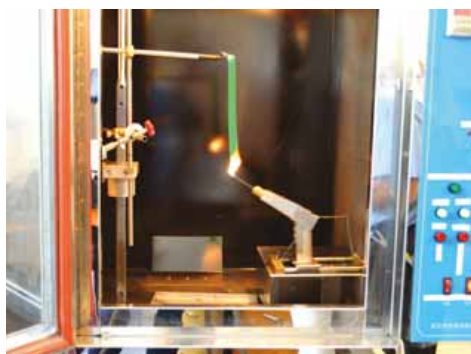
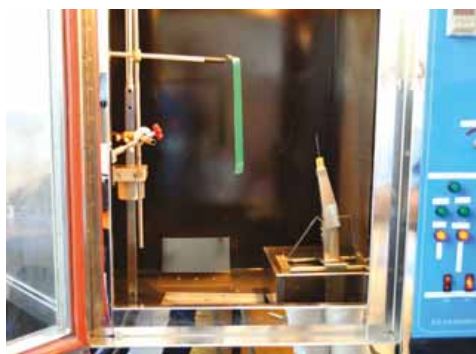
Az Izzóhuzalos és a Tűlángos vizsgáló berendezésekkel műanyag termékeink tűzveszélyességét vizsgáljuk.



Ön vulkanizáló, szigetelő szalagok

TRACON		
ONVSZ19	10 m × 19 mm	0,5±0,05 mm
ONVSZ25	10 m × 25 mm	0,5±0,05 mm
ONVSZ38	10 m × 38 mm	0,5±0,05 mm



Fekete színű, összeragadás ellen műanyag filmmel elválasztott, éghető, poli-izobutilén szalagok.

Főbb felhasználási területei: elsősorban gyengeáramú, valamint kábel televíziós vezetékek és telefon kábelek kötése, csővezetékek korrózió védelme, erősáramú kis- és közép feszültségű kábelek szerelése 36 kV-ig, de ez utóbbi – az éghetőség miatt – csak hőhatásnak nem kitett esetekben.



Vászon szigetelő szalag

F_t (N) 1.5 N/cm	ΔL 20 %	F_{sz} 40 N/cm	To -40..+105°C
--------------------------------------	-------------------	----------------------------------	--------------------------

TRACON		
TVSZ25	25 m × 25 mm	0,3 mm



Fekete PE extrudált szövetszalag.

Alapja 55 szemes szőtt PET/műselyem szövet hordozó, amelyet nyomásérzékeny természetes gumiragasztóval vontak be.



Speciális szövetszalag

F_t (N) 9 N/cm	ΔL 20 %	F_{sz} 40 N/cm	T_a -5..+60°C	PE
------------------------------------	-------------------	----------------------------------	-----------------------------------	-----------



TRACON		
SV50	50 m × 50 mm	0,15 mm

Nagy tapadóerővel az ipar minden területe számára. Alkalmos rögzítésre, jelölésre, kötegelésre.



Ipari padlójelölő szalag

F_t (N) 4 N/25 mm	ΔL 200 %	F_{sz} 45 N/25 mm	To -40..+105°C	PVC
---------------------------------------	--------------------	-------------------------------------	--------------------------	------------

TRACON		
BY50	33 m × 50 mm	0,15 mm

Üzemcsarnokok, raktárak közlekedési útvonalainak és veszélyes helyeinek kijelölésére, közismert nevén útvonaljelölő szalag.



Kétoldalú ragasztószalag



TRACON	
KOR50	25 m × 50 mm
KOHR10*	25 m × 10 mm
KOHR24*	25 m × 24 mm

* habosított

Maszkolószalag



TRACON	
MSZ18	35 m × 18 mm
MSZ24	35 m × 24 mm
MSZ36	35 m × 36 mm
MSZ48	35 m × 48 mm

Csúszást csökkentő szalag, fekete

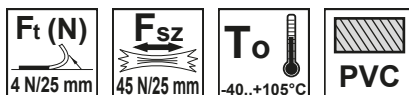

TRACON		H (mm)
SRTB25	5 m × 25 mm	0,75 mm
SRTB50	5 m × 50 mm	0,75 mm

Csúszást csökkentő jelölőszalag, sárga-fekete

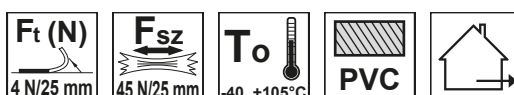

TRACON		H (mm)
SRTYB25	5 m × 25 mm	0,75 mm
SRTYB50	5 m × 50 mm	0,75 mm

PG tömítőszelencék

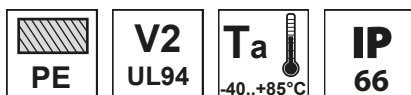

TRACON	mm	T (mm)	B (mm)	d (mm)	D (mm)	L ₁ (mm)	L ₂ (mm)
PG-7	3.5 - 6.5	16	18	6	12	10	22
PG-9	4.5 - 7	19	22	8	15	10	25
PG-11	5.5 - 10	22	23	10	18	8	29
PG-13,5	9 - 13	23	26	13	20	10	29
PG-16	10 - 14	26	29	14	21	9	29
PG-21	14 - 18	32	35	19	28	12	35
PG-29	18 - 25	41	45	26	36	12	40
PG-36	25 - 30	52	58	31	46	12	45
PG-42	30 - 38	57	56	37	51	14	40
PG-48	37 - 44	65	71	43	58	21	50

Rögzítő menet: páncélcső

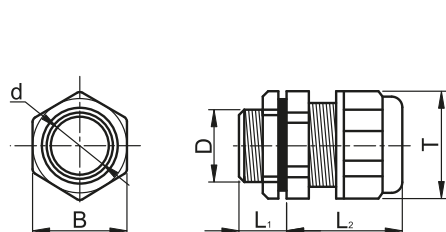

Membrános gumitömítés PG tömítőszelencéhez

TRACON	mm
PG7-G	3,5-6
PG9-G	7,5-8,5
PG11-G	7-9,5
PG13,5-G	9-12
PG16-G	11-14
PG21-G	14-17,5
PG29-G	22-25
PG36-G	26-33
PG42-G	31-37
PG48-G	37-43

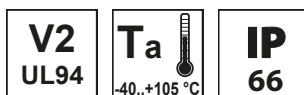

PG fémből készült tömítőszelencék



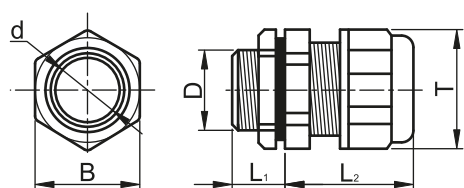



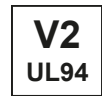
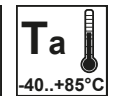



TRACON	mm	T (mm)	B (mm)	d (mm)	D (mm)	L ₁ (mm)	L ₂ (mm)
PGF-7	2 - 5	16	14	7.4	12.5	7	15
PGF-9	3-6.5	19	17	8.8	15	8	17
PGF-11	4-8	22	20	10.7	18.5	8	17
PGF-13,5	5-10	24.2	22	12.7	20	8	19
PGF-16	6-12	26.5	24	14.6	22.4	8	20
PGF-21	12-16	33	30	18.6	28.2	9	22
PGF-29	14-21	44	40	25.7	36.8	10	25
PGF-36	23-30	55	50	33.6	46.8	11	28
PGF-42	30-35	63	57	39.5	53.8	13	30
PGF-48	35-40	70	64	44.7	59	14	32



Rögzítő menet: páncélcső
Anyag: réz (nikkelezve)RELEVANT STANDARD
MSZ EN 62444

MG Metrikus tömítőszelencék





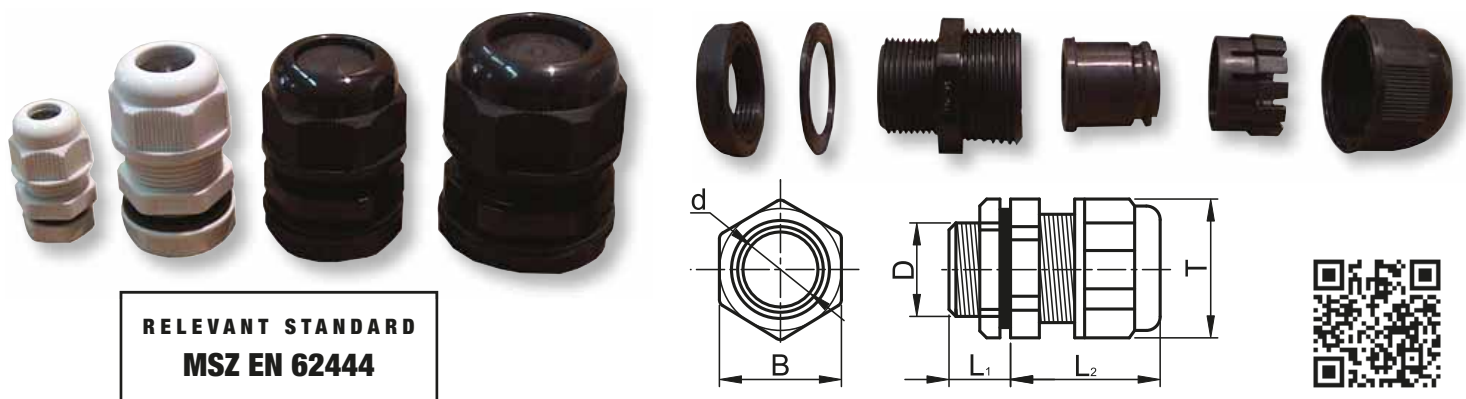





TRACON			T (mm)	B (mm)	d (mm)	D (mm)	L ₁ (mm)	L ₂ (mm)
MG-12		3.5 - 7.5	18.3	17.3	7.6	M12	9	27
MG-16		5 - 10	22	21.7	10.6	M16	15	30
MG-20		6.5 - 14	29.5	27	14.5	M20	14	37
MG-25		12 - 18	32.6	32.6	18	M25	14	37
MG-32		15 - 24	40.6	40.5	26	M32	15	42
MG-40		21 - 30	49.4	48.9	30.8	M40	20	46
MG-50		30 - 40	62.1	60.6	40.6	M50	22.5	54
MG-63		40 - 50	81	76	52.5	M63	23.8	57







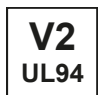
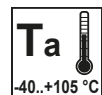



RELEVANT STANDARD
MSZ EN 62444



MG fémből készült metrikus tömítőszelencék



TRACON			T (mm)	B (mm)	d (mm)	D (mm)	L ₁ (mm)	L ₂ (mm)
MGF-12		3-6.5	15.5	14	7.5	M12 × 1.5	6.5	15
MGF-16		4-8	20	18	9	M16 × 1.5	8	16
MGF-18		5-10	22	20	10.6	M18 × 1.5	8	17
MGF-20		6-12	24	22	12.7	M20 × 1.5	8	19
MGF-25		8-14	26.5	24	14.6	M25 × 1.5	9	19
MGF-32		15-22	38	35	22.8	M32 × 1.5	10	23
MGF-40		18-25	43.8	40	25.6	M40 × 1.5	11	25
MGF-50		32-38	63	57	39.4	M50 × 1.5	13	30
MGF-63		37-44	70	64	44.8	M63 × 1.5	14	31

Anyag: réz (krómozva)



RELEVANT STANDARD
MSZ EN 62444



Metrikus tömítőszelence törésgátló kábelbevezetővel

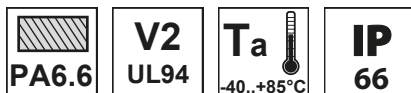

TRACON	mm	D ₁ (mm)	D ₂ (mm)	B ₁ (mm)	L ₁ (mm)	L ₂ (mm)	L ₃ (mm)
MG-12TG	3 - 6.5	M12 × 1.25	8.3	6	7.9	12.1	53.3
MG-16TG	5 - 10	M16 × 1.5	10.9	9.6	14.4	14.4	74.9
MG-20TG	10 - 14	M20 × 1.5	14.8	12.9	12.8	19.5	96.2
MG-25TG	13 - 18	M25 × 1.5	18.5	16.5	13.9	19.5	111.2

Törésgátló spirállal egybeépített tömítőszelencéket alkalmazhatunk hajlékony kábeleknél és minden olyan esetben és helyen, ahol fontos a nagy megbízhatóság és a kábel törés elleni védelme.



RELEVANT STANDARD
MSZ EN 62444

RELEVANT STANDARD
EN 60423

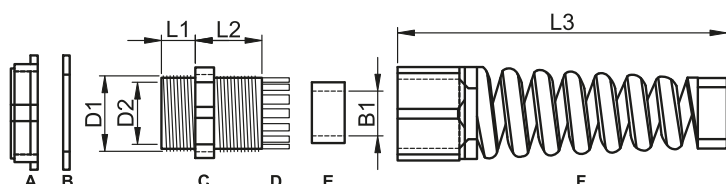

A – Rögzítőanya
B – Alátét gyűrű

C – Test
D – Köröm

E – Tömítés
F – Szorítóanya a törésgátló spirállal



Metrikus szűkítő közcsavar

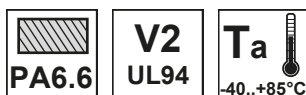

TRACON	D ₂ (mm)	D ₁ (mm)	L (mm)	W (mm)
TMSZ-20/12	M20 × 1.5	M12 × 1.5	8	24.2
TMSZ-20/16	M20 × 1.5	M16 × 1.5	8	24.2
TMSZ-25/16	M25 × 1.5	M16 × 1.5	8	29
TMSZ-25/20	M25 × 1.5	M20 × 1.5	8	29
TMSZ-32/20	M32 × 1.5	M20 × 1.5	10	35.9
TMSZ-32/25	M32 × 1.5	M25 × 1.5	10	35.9
TMSZ-40/32	M40 × 1.5	M32 × 1.5	10	45.8
TMSZ-50/40	M50 × 1.5	M40 × 1.5	11.5	55
TMSZ-63/50	M63 × 1.5	M50 × 1.5	11.5	67.5

Az alkalmazni kívánt tömítőszelence méreténél nagyobb furatátmérővel rendelkező kábelátvezetés leszűkítésére használhatjuk. A közcsavarhoz rögzítőanya rendelhető, lásd következő oldal!

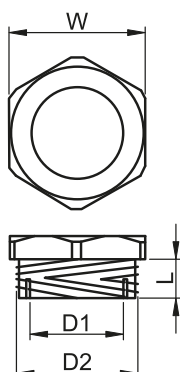

RELEVANT STANDARD
EN 60423

Metrikus rögzítőanyagák

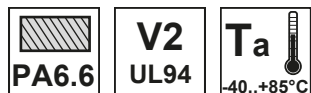

TRACON		d (mm)	B (mm)	H (mm)
MG-12-A	MG12	M12 × 1.5	17.5	5
MG-16-A	MG16	M16 × 1.5	22	7
MG-20-A	MG20	M20 × 1.5	26.5	7.5
MG-25-A	MG25	M25 × 1.5	33	8
MG-32-A	MG32	M32 × 1.5	40.5	8
MG-40-A	MG40	M40 × 1.5	49	10
MG-50-A	MG50	M50 × 1.5	60.5	9.5
MG-63-A	MG63	M63 × 1.5	73.5	11



Alkalmazható metrikus tömítőszelencék, szűkítő közcsavar és záródugók kivágási furatokban való rögzítésére.



RELEVANT STANDARD
EN 60423

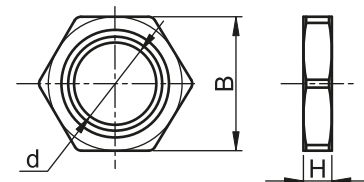

Metrikus záródugó

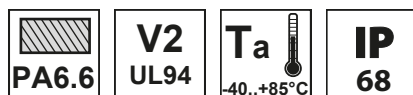

TRACON	A (mm)	B (mm)	C (mm)	D (mm)
TMZ-12	M12 × 1.5	15	10	6
TMZ-16	M16 × 1.5	20	10.5	6
TMZ-20	M20 × 1.5	24	10.5	6
TMZ-25	M25 × 1.5	29.7	12.8	7.8
TMZ-32	M32 × 1.5	36.6	13.3	7.8
TMZ-40	M40 × 1.5	45.8	13.4	7.8
TMZ-50	M50 × 1.5	55.5	16.2	9.8
TMZ-63	M63 × 1.5	69.3	17.5	11.8



Általánosan felhasználható kábelátvezetések lezárására. A záródugóhoz rögzítőanya rendelhető.



RELEVANT STANDARD
EN 60423

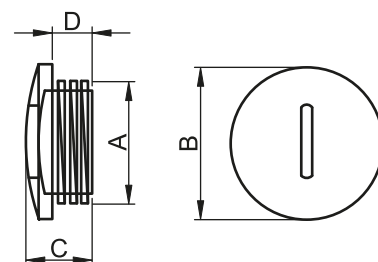

Gégecsőhöz illeszkedő kiegészítő gyorscsatlakozó

V2
UL94T_a
-40...+85°CIP
55

Piktogramok

M/O

TRACON	D ₁ (mm)	D ₂ (mm)	D ₃ (mm)	L ₁ (mm)	L ₂ (mm)	L ₃ (mm)	
GCS-16	15,9	11	10,8	10	17,9	15,7	16 mm
GCS-20	19,2	15	14,7	10	17,7	16	20 mm
GCS-25	25	18,9	19,8	11,4	23,6	20,6	25 mm
GCS-32	31,2	26	24,3	12	22,8	20,6	32 mm
GCS-40	37,5	31,5	31,6	11,3	23,6	20,7	40 mm
GCS-50	44	37,5	39,5	12,6	21,6	20,7	50 mm



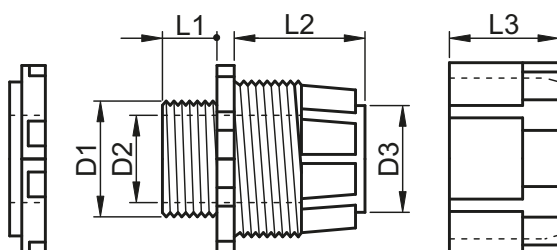

Alkalmazható gégecsővek elosztó- kötődobozokhoz, szekrényekhez való csatlakoztatására.

RELEVANT STANDARD
MSZ EN 62444



Kábelátvezető (nyitott-zárt)

T_o
-0...+90°CV2
UL94Silicon
free

TRACON		A (mm)	B (mm)	C (mm)	D (mm)	E (mm)
						
BV0603	BVZ0603	8,5	6	3	4,7	1,7
BV0705	BVZ0706	10,2	7,2	5	4,4	1,7
BV1006	BVZ1006	13,3	10	6,4	6,3	1,7
BV1108	BVZ1108	15,5	11	7,8	9	3
BV1410	BVZ1410	19,5	13,9	10,5	6,4	3,4
BV2015	BVZ2015	23,7	20,1	15,5	6,1	1,7
BV2518	BVZ2518	29,9	25,1	18,9	7,2	1,5
BV3225	BVZ3225	38,1	31,7	25	7,8	1,5

A külső hatásoknak ellenálló védőgyűrűket elsősorban szigetelt vezetékeknek fém szerelőlapon készített éles szélű furatokon történő átvezetésére ajánljuk.

A vékony hátyával készült zárt kivitelek különböző kötődobozokhoz vezeték bevezető tömítésként is alkalmazható, az átvezetett kábelek, vezetékek megtörését, sérülését megakadályozza.

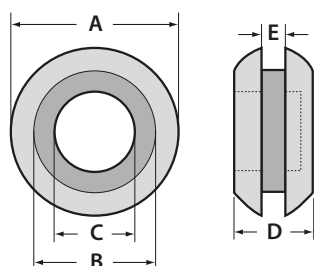

Tömítőszelencés kábeltoldó



U_i
660 V

IP
65

PA6.6

TRACON	mm ²			xP 	L (mm)	D (mm)	U _n	I _n	IP..
	In	Out							
CST1	0.5-1	0.5-1	PG9	3	68	21	250 VAC	13 A	IP 65
CST4	0.5-4	0.5-4	MG25	5	123	33	450 VAC	24 A	IP 68
CST4-T	0.5-4	0.5-2.5 (4)	MG25	5	110	33	450 VAC	24 A	IP 68
CST4-T3P	2,5 (4)	2,5 (4)	MG25	3	110	33	450 VAC	24 A	IP 68
CST4-Y	0.5-4	0.5-2.5 (4)	MG25	5	150	33	450 VAC	24 A	IP 68
CST4-Y3P	2.5 (4)	2.5 (4)	MG25	3	150	33	450 VAC	24 A	IP 68
CST15B	0.5-1.5	0.5-1.5	MG20	3	90	27	450 VAC	16 A	IP 68
CST15W	0.5-1.5	0.5-1.5	MG20	3	74	26	450 VAC	16 A	IP 68
CST25	0.5-2.5	0.5-2.5	MG20	3	74	26	250 VAC	16 A	IP 65
CST25F	0.5-2.5	0.5-2.5	MG20	3	107	29	250 VAC	16 A	IP 68
CSTBOX	0.5-1	0.5-1	PG9	3	116	–	250 VAC	13 A	IP 65

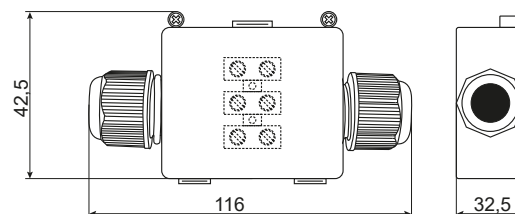
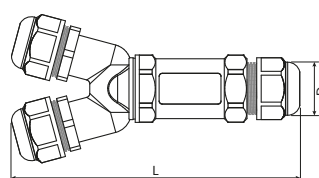
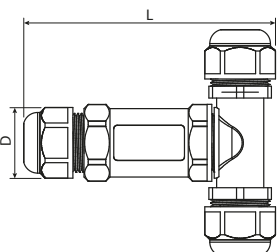

Vezetékre húzható vezetékjelölők



TRACON	mm ²		pcs
J020...J029	0.2...1.5	0, 1, ..., 9	10-100
J02-	0.2...1.5	-	10-100
J02+	0.2...1.5	+	10-100
J02GND	0.2...1.5	⊥	10-100
J02X	0.2...1.5	X	10-100
J02Y	0.2...1.5	Y	10-100
J150...J159	1.5...4	0, 1, ..., 9	10-100
JSET	1.5...4	0, 1, ..., 9	10 × 50
J15A...J15Z	1.5...4	A, B, ..., Z	10-100
J15/	1.5...4	/	10-100



TRACON	mm ²		pcs
J15-	1.5...4	-	10-100
J15+	1.5...4	+	10-100
J15GND	1.5...4	⊥	10-100
JSET/B	1.5...4	⊥, A, B, J, 0, R, S, T, +, -	10 × 50
J40...J49	4...10	0, 1, ..., 9	10-100
J4A...J4Z	4...10	A, B, ..., Z	10-100
J4-	4...10	-	10-100
J4+	4...10	+	10-100



Öntapadós jelzőcímkék

A 20 mm átmérőjű jelzőcímkéket elosztószekrényekben, készülékekben gyűjtősínek, csatlakozókapcsok jelölésére ajánljuk.

TRACON	Megnevezés	Jelző-címke
JC01	1. fázisvezető váltakozó áramú rendszerekben	L1
JC02	2. fázisvezető váltakozó áramú rendszerekben	L2
JC03	3. fázisvezető váltakozó áramú rendszerekben	L3
JC04	Pozitív áramvezető egyenáramú rendszerekben	L+
JC05	Negatív áramvezető egyenáramú rendszerekben	L-
JC06	Nullavezető	N
JC07	Egyenáramú hálózat középvezetője	M
JC08	Elkülönített védővezető	PE



TRACON	Megnevezés	Jelző-címke
JC09	Egyenáramú hálózat földelt középvezetője	PE
JC10	Egyenáramú hálózat földelt középvezetője	PE
JC11	Európai Megfelelőségi jelölés	CE
JC12	Robbanásbiztos készülék (régebbi)	Ex
JC13	Robbanásbiztos készülék	Ex
JC14	Üzemi földelőkapocs	⊥
JC15	Védővezető csatlakozókapocs	⊥



Sorolósínek 125 A-ig

230/400 V AC	U _i 500 V	T _a -40...+85°C	V0 UL94
-----------------	-------------------------	-------------------------------	------------



TRACON	In	A mm ²	×17.5	L (mm)	H (mm)	h (mm)	W (mm)	xP
TFSS-1	max. 63 A	10 mm ²	56 mod.	1000	15.4	4.8	12.5	1
TFSS-1-12	max. 63 A	10 mm ²	12 mod.	215	15.4	4.8	12.5	1
TFSS-1+N	max. 63 A	10 mm ²	54 mod.	1000	19	9.2	21/15.3	1+N
TFSS-2	max. 63 A	10 mm ²	56 mod.	1000	29.4	17	10.4	2
TFSS-3	max. 63 A	10 mm ²	56 mod.	1000	29.5	18	21	3
TFSS-3-12	max. 63 A	10 mm ²	12 mod.	215	29.5	18	21	3
TFSS-4	max. 63 A	10 mm ²	56 mod.	1000	29.5	18.3	21.6	4
TFSS-1V	max. 63 A	10 mm ²	56 mod.	1000	14.8	5	15	1
TFSS-1V-12	max. 63 A	10 mm ²	12 mod.	215	14.8	5	15	1
TFSS-2V	max. 63 A	10 mm ²	56 mod.	1000	28.5	17	10.4	2
TFSS-3V	max. 63 A	10 mm ²	56 mod.	1000	28.5	17	15.5	3
TFSS-3V-12	max. 63 A	10 mm ²	12 mod.	215	28.5	17	15.5	3
TFSS-4V	max. 63 A	10 mm ²	56 mod.	1000	30	18.2	21.1	4
TFSS100-1	max. 100 A	25 mm ²	37 mod.	1000	13.7	4.5	16.8	1
TFSS125-1	max. 125 A	35 mm ²	37 mod.	1000	18.4	4.7	19.1	1

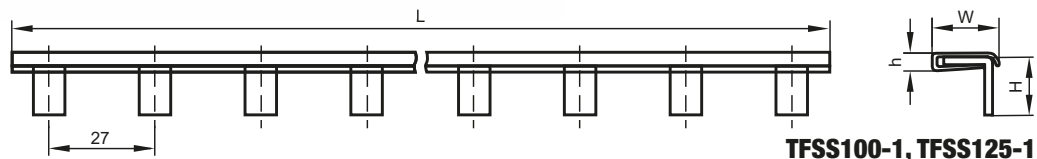
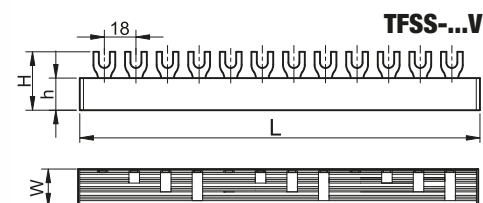
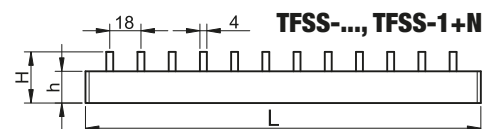
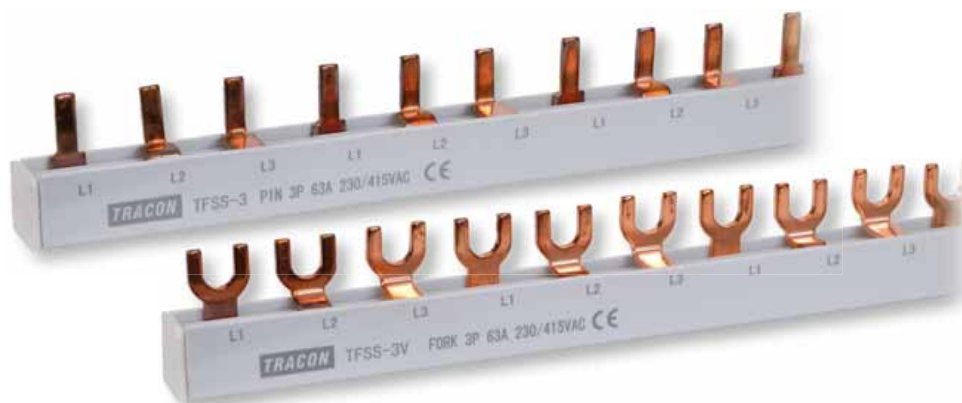

Egyéb kiegészítők

TRACON	Megnevezés
TFSS-1Z	Záróidom 1 pólusú 63A-es sorolósínekhez
TFSS-2Z	Záróidom 2 pólusú 63A-es sorolósínekhez
TFSS-3Z	Záróidom 3 pólusú 63A-es sorolósínekhez
TFSS-4Z	Záróidom 4 pólusú 63A-es sorolósínekhez
TFSS-1CS	csavaros csatlakozókapocs max. 25 mm ² -es vezetékhez
TFSSCOV	Érintésvédelmi burkolat

A TFSS- kódjelű sorolósínek kismegszakítók betáplálási oldalainak közösítésére, összekötésére szolgálnak. A csapos kivitelek hüvely kapcsokhoz, a villás kivitelek csavarfejjel szorítócsavaros csatlakozókapcsokhoz használhatók. A sorolósínek a szükséges méretre darabolhatók. Nagyobb áramú kismegszakítók és installációs készülékek betáplálására javasoljuk a **TFSS100-1** és **TFSS125-1** sorolósínek! 27 mm-es osztástávolságuk miatt az egy modul széles (18mm) készülékek között 5 mm légtér alakul ki, így kevésbé lesz hőmérsékletfüggő a maximális terhelési áram. A pólusok egymáshoz képest kis mértékben elmozdíthatók.

Szerelősínek

TRACON	L (mm)
35/7,5SIN-1000	1000
35/7,5SIN-500	500
35/7,5SIN-137	137
35/7,5SIN-60	60
35/7,5SIN-20	20
35/7,5SIN-T-1000	1000
35/7,5SIN-T-200	200

Sorolható készülékek rögzítésére szolgáló 35 × 7.5 mm méretű „kalap” formájú galvanizált acél sínek.

Felerősítésük csavarral történik, ezért furattal, a hosszabb méretűek pedig ovális lyuksorozattal rendelkeznek.

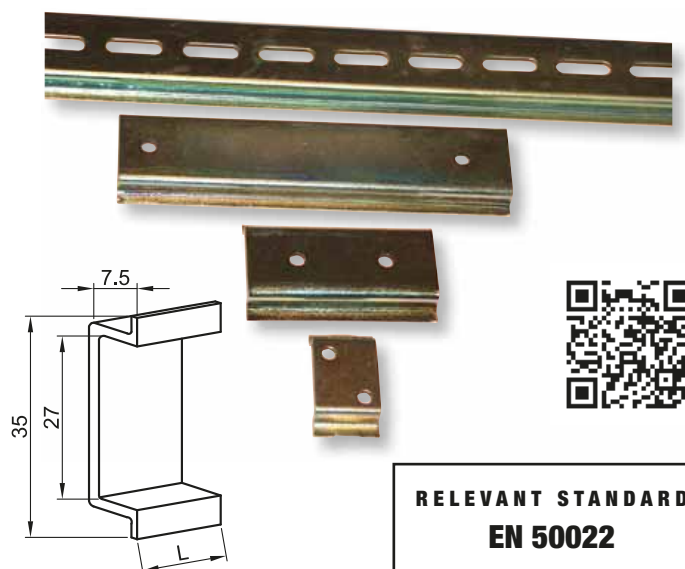

RELEVANT STANDARD
EN 50022

Rézszintartó bakok

U_i
660 V

$PA6.6$

T_o
 -15...+55°C

V1
 UL94



TRACON	Megnevezés	
TNFSB1	Síntartó bak 1 db N/PE sínhez	TNFS, TNFS10, TNFS16, TNFS25
TNFSB	Síntartó bak 2 db N/PE sínhez	TNFS

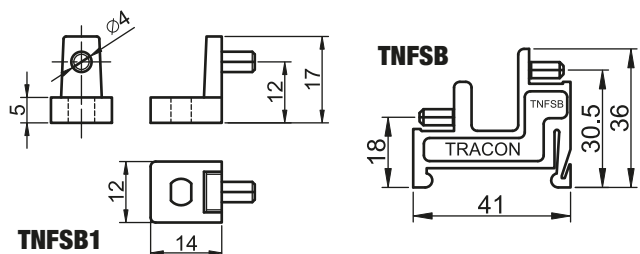

RELEVANT STANDARD
EN 50022

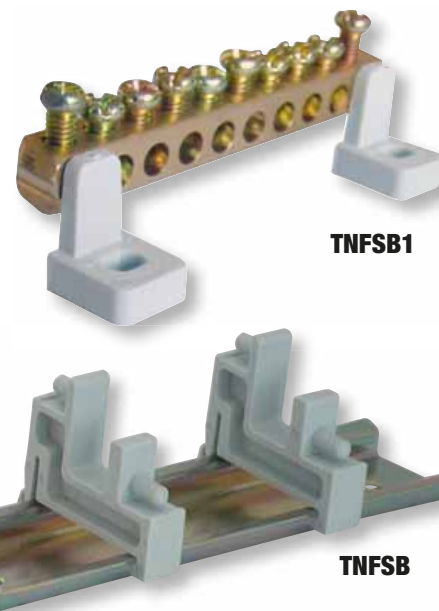

Rézszín (N/PE sín)

230/400
V AC

I_n
 max.
63 A

Cu



TRACON	H (mm)	W (mm)	L (mm)	∅ (mm)	x	mm ²	
TNFS	8	8	1.000	5.1	138 × M4	10	6
TNFS10	10	6.1	1.000	4.3	166 × M4	10	6
TNFS16	10	6.1	1.000	5	133 × M4	16	6
TNFS25	12	8	1.000	7.6	101 × M5	25	16
TNFS2516	12	7	152	7.8	14 × M5	16	10
				5.5	5 × M6	25	16

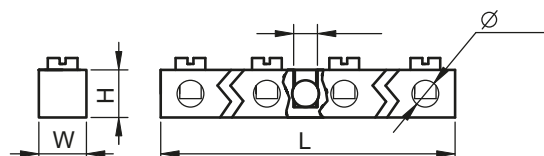

RELEVANT STANDARD
EN 60998



Szigetelt földelő sín



230/400 V AC	U _i 500 V	Cu	PA6.6	IP 20	T_a -40..+85°C	35x7.5	V1 UL94
-----------------	-------------------------	----	-------	-----------------	------------------------------------	--------	-------------------

TRACON	(mm)	x	I_n		mm ²	L (mm)	L₁ (mm)	L₂ (mm)	H (mm)	W (mm)	d (mm)	M	
NPE-ZB		12				88	-	-	26	13	5,5	M5	
NPE-ZG		12				88	-	-	26	13	5,5	M5	
NPE-B6-4	6 × 9	4	max. 63 A	2,5-16	2,5-10	-	49	34	35	10,5	5	M4	
NPE-B6-6		6				-	49	47	35	10,5	5	M4	
NPE-B6-8		8				-	70	60	35	10,5	5	M4	
NPE-B8-6		6				-	66	57	39	12,6	7	M5	
NPE-B8-8		8				-	79	34	28	10,5	7	M5	
NPE-B8-10	8 × 12	10	max. 100 A	4-35	4-25	-	100	91	39	12,6	7	M5	
NPE-B8-12		12				-	118	109	39	12,6	7	M5	
NPE-B8-14		14				-	134	137	39	12,6	7	M5	
NPE-G6-4	6 × 9	4	max. 63 A	2,5-16	2,5-10	-	49	34	35	10,5	5	M4	
NPE-G6-6		6				-	49	47	35	10,5	5	M4	
NPE-G6-8		8				-	70	60	35	10,5	5	M4	
NPE-G8-6		6				-	66	57	39	12,6	7	M5	
NPE-G8-8		8				-	79	34	28	10,5	7	M5	
NPE-G8-10	8 × 12	10	max. 100 A	4-35	4-25	-	100	91	39	12,6	7	M5	
NPE-G8-12		12				-	118	109	39	12,6	7	M5	
NPE-G8-14		14				-	134	136	39	12,6	7	M5	
NPE-Z-24*	6 × 9	24	max. 63 A	2,5-16	2,5-10	250	-	-	18,3	7,6	4×5,4+20×4,3	M4×20+M5×4	
NPE-Z-38*	8 × 12	38	max. 100 A	4-25	2,5-16	360	-	-	26,6	13,7	10×7,5+28×5,2	M6×10+M5×28	

* szerelőlapra való alkalmazáshoz

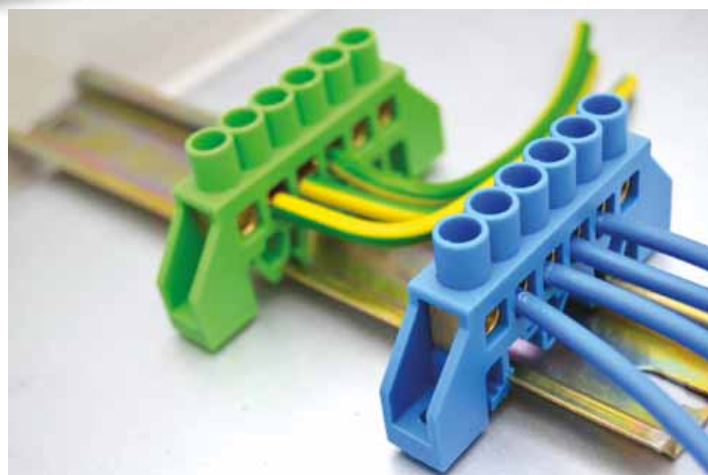
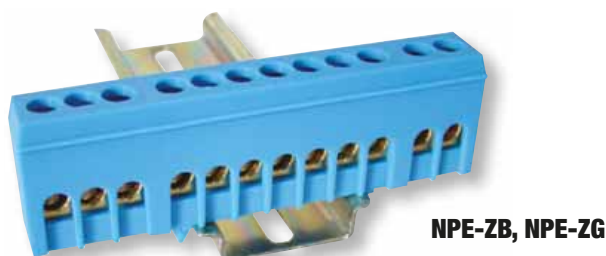
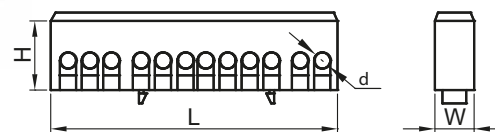
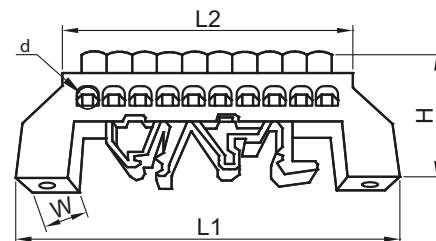
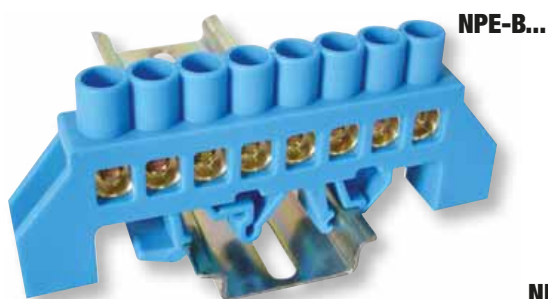

Falon kívüli kötődobozok



TRACON	D (mm)	L (mm)	W (mm)	H (mm)	IP..		d ₁ (mm)	d ₂ (mm)	
TQBYD70	70	–	–	40	IP 44	TQBY2-GB	23	29	
TQBYD85	85	–	–	45	IP 44	TQBY2-GB	23	29	
TQBY884	–	80	80	40	IP 44	TQBY2-GB	23	29	
TQBY8125	–	80	120	50	IP 44	TQBY3-GB	29 ±1	35 ±1	
TQBY10105	–	100	100	50	IP 54	TQBY3-GB	29 ±1	35 ±1	
TQBY15117	–	150	110	70	IP 54	TQBY3-GB	29 ±1	35 ±1	
TQBY15157	–	150	150	70	IP 54	TQBY4-GB	38 ±1	44 ±1	
TQBY19148	–	190	145	80	IP 65	TQBY4-GB	38 ±1	44 ±1	
TQBY25209	–	250	200	90	IP 65	TQBY4-GB	38 ±1	44 ±1	
TQBY312313	–	310	230	130	IP 65	TQBY5-GB	49 ±1	57 ±1	

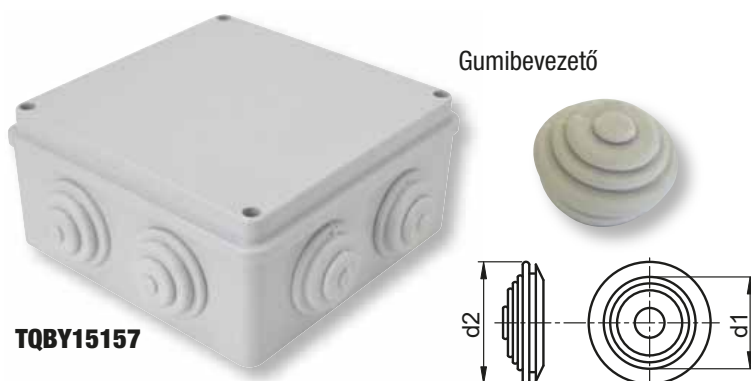
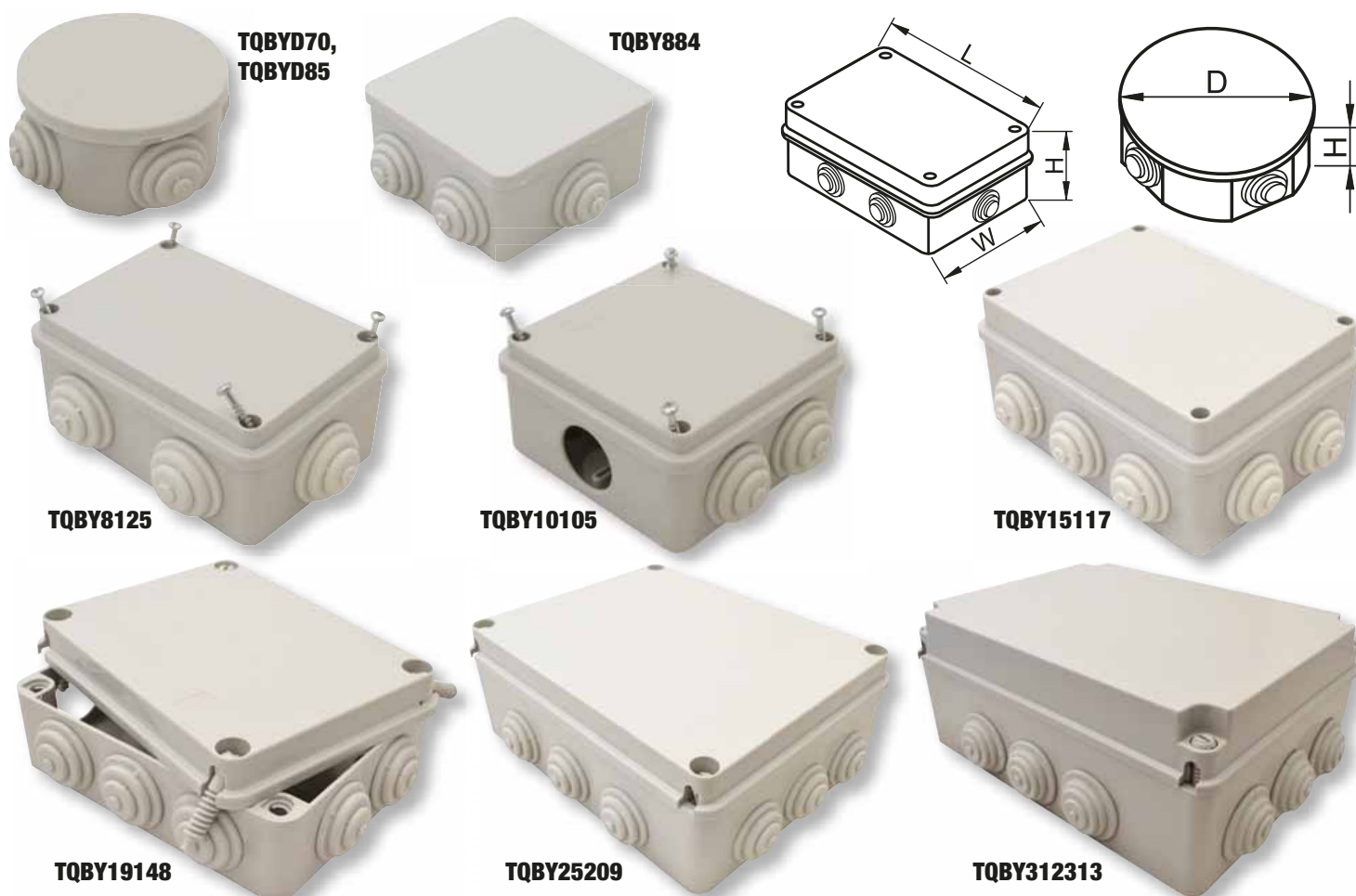

Elektronikai doboz



TRACON		W (mm)	L (mm)	H (mm)	IP..	
MED884	To -25..+60°C	80	80	40	IP 44	CLICK
MED8125		80	120	50	IP 54	
MED10105		100	100	50	IP 54	
MED15117	To -25..+60°C	150	110	70	IP 54	
MED15117S*		150	110	70	IP 54	METAL
MED15157		150	150	70	IP 55	
MED15157T		150	150	70	IP 55	
MED12085*	Ta -10..+55 °C	120	80	50	IP 56	
MED383012		380	300	120	IP 56	
MED19148		190	145	80	IP 67	PLASTIC
MED19148T		190	145	80	IP 67	
MED25209	To -25..+60°C	250	200	90	IP 67	
MED25209T		250	200	90	IP 67	
MED312313		310	230	130	IP 67	
MED312313T		310	230	130	IP 67	

* kikönyvítés nélkül.



MED8125,
MED10105,
MED15117,
MED15157



MED19148,
MED25209,
MED312313

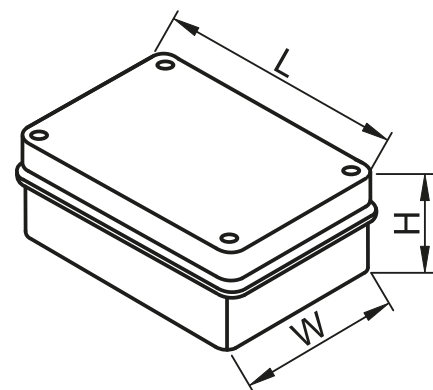

MED19148T,
MED25209T,
MED312313T,
MED15157T



MED383012



OLVASSA BE A KÓDOT!

- Nézze meg újdonságainkat
- Legyen naprakész

Kínálatunk gyorsan és folyamatosan fejlődik!
Katalógusunk a 2021. áprilisi állapotot tükrözi.
Naprakész információért
látogasson el honlapunkra!

Műanyag doboz



TRACON	W (mm)	L (mm)	H (mm)	
MD81212	80	120	120	-
MD101012	100	100	120	-
MD151114	150	110	140	-
MD191514	190	145	140	MD-SZL1
MD252016	250	200	160	MD-SZL2
MD312318	310	230	180	MD-SZL3
MD151114T	150	110	140	-
MD191514T	190	145	140	MD-SZL1
MD252016T	250	200	160	MD-SZL2
MD312318T	310	230	180	MD-SZL3

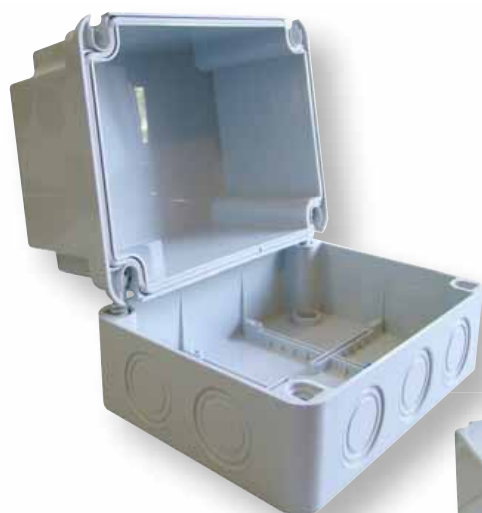

Galvanizált szerelőlap MD-dobozokhoz

TRACON	
MD-SZL1	172 × 127 mm
MD-SZL2	228 × 179 mm
MD-SZL3	290 × 210 mm

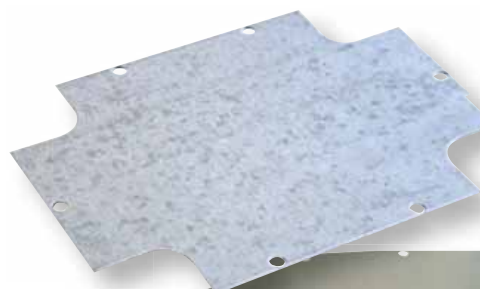

MD-SZL1



MD-SZL2

RELEVANT STANDARD
EN 60670

RELEVANT STANDARD
EN 60423

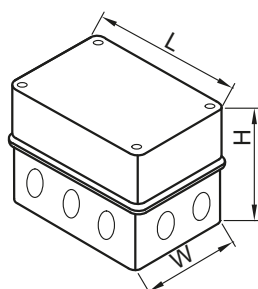

CO ÉRZÉKELŐ

TRACON
.....**ELECTRIC**®



F/50

Műanyag szerelődobozok



Piktogramok M/O



TRACON	L (mm)	W (mm)	H (mm)	IP..	
DN200X200	200	200	85	IP 44	× 2
DN250X250	250	250	110	IP 44	× 4

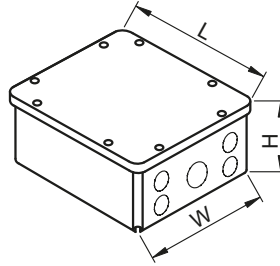

Falon kívüli rugalmas kötődobozok



Piktogramok M/O



TRACON	L (mm)	W (mm)	H (mm)	IP..	
PD75X35	80	42	40	IP 54	× 8
PD75X75	75	75	40	IP 54	× 12
PD85X85	85	85	37	IP 54	× 12
PD100X100	100	100	40	IP 54	× 12

RELEVANT STANDARD
EN 60670

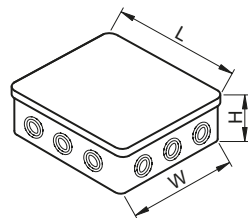

Gipszkarton dobozok



Piktogramok M/O



TRACON		L (mm)	W (mm)	H (mm)
GD6021	szervénydoboz, sima	65	65	45
GD60	szervénydoboz, mély	65	65	60
GD8021	kötődoboz, fedéllel	80	80	45
GD100	kötődoboz, fedéllel	100	100	45
GD71D	szervénydoboz, dupla	140	65	45

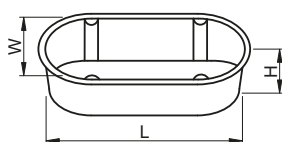
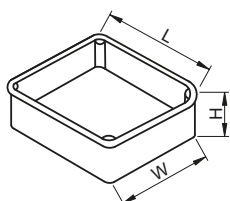

GD71D



GD6021



GD100



Süllyesztett perforált kötődobozok

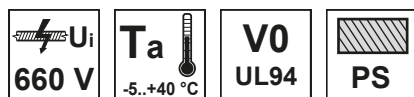

TRACON		D (mm)	H (mm)	W (mm)	L (mm)	H (mm)
D70	sima	70	45	—	—	—
D70SET	vakolófedéllel	70	45	—	—	—
D80	sima	80	45	—	—	—
D80X80	négyzetes	—	—	76	97	51.5
D100X100	négyzetes	—	—	100	116	51.5
D150X150	négyzetes	—	—	150	166	65.3

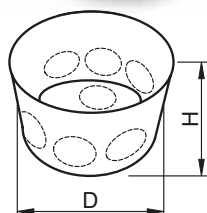
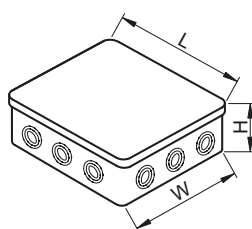

Süllyesztett perforált szerelvénydobozok

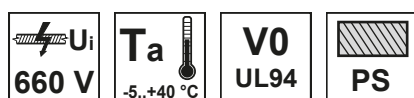

TRACON		D (mm)	L (mm)	W (mm)	H (mm)	
D60	sima	62	-	-	40	2
D60S	sima, sorolható	64	15	-	40	2
D60SM	mély, sorolható	64	-	-	61	4
D70SZ	sima	72	-	-	36	9
D70SZT	sima, tetővel	72	-	-	36	9
D70D	dupla	70	140	70	44	8
D70TRI	tripla	70	212	70	44	12
D70/8	nyolcszögletű, sorolható	-	72	72	46	2

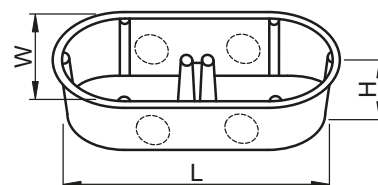
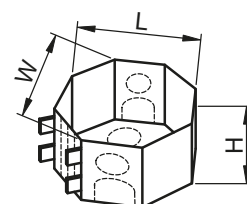
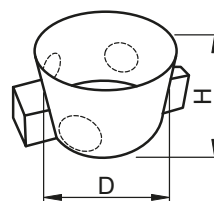

Dobozfedelek

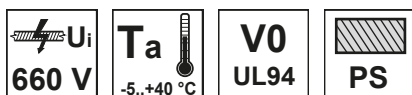

TRACON		Ø (mm)
D60T	rúgós, fehér	69
D70T	rúgós, fehér	75
D80T	rúgós, fehér	89
VAKFED60	vakolófedél	65
VAKFED70	vakolófedél	76



RELEVANT STANDARD
EN 60670



Univerzális szerelvénydoboz

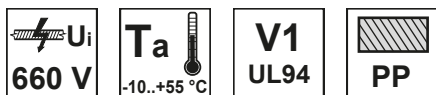

TRACON	H (mm)	D (mm)
UD70	110 - 130 - 160 mm	70

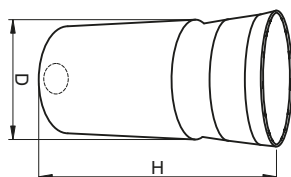

Külső szigetelt és burkolt falak szerelvényezéséhez alkalmazható. Az 1-es dobozt a hagyományos dobozokhoz hasonlóan a falba süllyeszteszük. Legalább 40, legfeljebb 80 milliméterre, olyan módon, hogy a 2-es doboz pereme valamelyik fokozatában a szigetelés külső síkjába essen.



Doboztoldás utólagos szigeteléshez

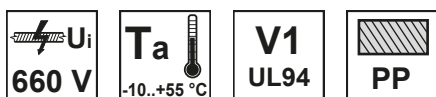

TRACON	H (mm)	D (mm)
UDT60	40 - 85 mm	70

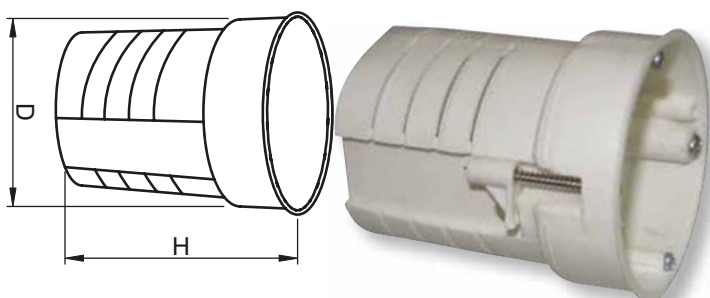

Szigetelt légvezeték-szerelvények

A kisfeszültségű szigetelt, saját súlya által mechanikailag terhelhető nullvezetővel rendelkező, pl. 1-AES, E-A2Y, KEVMEX-1, EX típusú légvezetékek gyors szerelését teszik lehetővé anélkül, hogy magát a légvezeték-hálózatot feszültségmentesíteni kellene. A szerelési művelet az élő hálózaton a szigetelt szerelvények és szigetelt szerszámok segítségével üzembiztosan elvégezhető.

A csavaros kötőelemek segítségével az épületek betápláló kábelének leágaztatása a légvezetékéről egyszerűen elvégezhető. Ha a közvilágítási tápfeszültség az energiaelosztó hálózat légvezetékének kísérő vezetéke által van biztosítva, a kötőelemek által a közvilágítási nyomvonal is könnyedén kiépíthető.

A mechanikailag terhelhető nullvezetőjű légvezetékek elvi elrendezését a mellékelt ábrák szemléltetik.

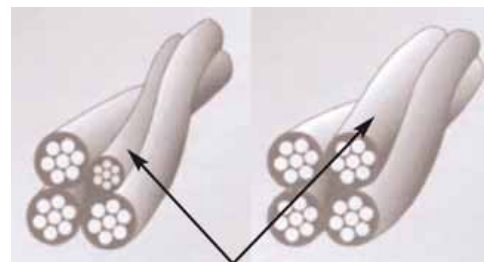

A légvezeték nullvezetője

Feszítő szerelvények

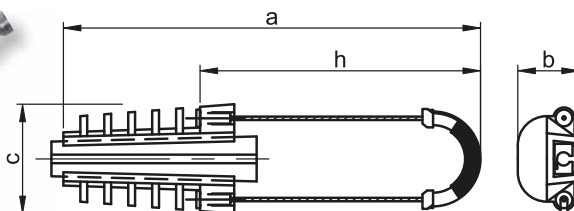

TRACON				a (mm)	b (mm)	c (mm)	h (mm)	
TSZK2-A	25-35 mm ²	2,5 kN	4 kN	250	35	63	162	4 kV
TSZK2-B	50-120 mm ²	2,5 kN	4 kN	420	55	100	275	4 kV



RELEVANT STANDARD
MSZ 275

A feszítő szerelvényekkel a szigetelt légvezetékek feszítő oszlophoz való rögzítése végezhető el gyorsan, egyéb szerszám felhasználása nélkül. A nullvezetőt a szerelvény gumi végébe kell behelyezni, majd a fém feszítő végét az oszlopon található kampóra akasztani. Feszítéskor a gumiágy erősen rászorul a kábelre, a feszítőerőt a kábel saját súlya biztosítja.

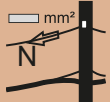
Függesztő szerelvények

TRACON			a (mm)	b (mm)	c (mm)	
TSZK1-A	25-35 mm ²	12 kN	120	83	40	4 kV
TSZK1-B	50-120 mm ²	12 kN	152	100	40	4 kV



TSZK1-A
Fix, szorítócsavarral



TSZK1-B
Csuklós, biztosító lappal

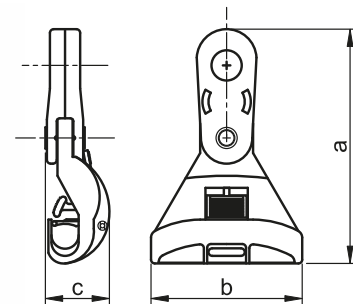

A feszítő szerelvényekkel a szigetelt légvezetékek feszítő oszlophoz való rögzítése végezhető el gyorsan, egyéb szerszám felhasználása nélkül. A nullvezetőt a szerelvény gumi végébe kell behelyezni, majd a fém feszítő végét az oszlopon található kampóra akasztani. Feszítéskor a gumiágy erősen rászorul a kábelre, a feszítőerőt a kábel saját súlya biztosítja.





Csavaros kötőelemek

A csavaros kötőelemmel üzembiztos erenkénti leágazást lehet létesíteni a feszültség alatt álló szigetelt légvezeték-hálózaton. Nagyfokú biztonságot jelent, hogy a szorítócsavar és az érintkezőkések közötti szigetelés átütési szilárdsága legalább 4 kV levegőben.

További védelmet jelent a leágazó vezeték végét takaró sapka felhelyezése, mely az érintés és a behatoló szennyeződések ellen véd.

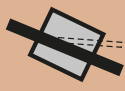



A mechanikai kapcsolat az érintkezőkések közvetítésével a vezeték szigetelésének átvágása után a megfelelő nyomatékkal meghúzott szorítócsavar által jön létre. A csatlakozás korrózióállóságát a csatlakozó terület speciális zsírzása biztosítja.

Normál csavarral szerelt kivitel

TRACON				X 
TSZL4-1	16-95 mm ²	10-25 mm ²	4 kV	1 × M8
TSZL4-2	70-95 mm ²	70-95 mm ²	4 kV	1 × M8
TSZL4-3	120-185 mm ²	16-25 mm ²	4 kV	1 × M8
TSZL4-4	70-185 mm ²	70-185 mm ²	4 kV	2 × M8

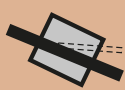



Szakadófejes szorítócsavarral szerelt kivitel

TRACON				X 
TSZL6-1	25-95 mm ²	2,5-25 mm ²	6 kV	1 × M8
TSZL6-2	70-95 mm ²	70-95 mm ²	6 kV	1 × M8
TSZL6-3	120-185 mm ²	10-25 mm ²	6 kV	1 × M8
TSZL6-4	120-185 mm ²	70-185 mm ²	6 kV	2 × M8

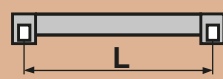

LTT Légvezeték-távartó

TRACON		
LTT	350 mm	max. 12 mm

A távolságtartó felhasználásával a 230/400 V-os kiefeszültségű légvezetési hálózatok szigetetlen vezetőknek egymástól való távolsága biztosítható két tartóoszlop között. Alkalmazásával megelőzhető az erős légmozgások, szélviharak által okozott zárlatok, üzemviteli zavarok kialakulása. A műanyagból készült távolságtartó kb. 350 mm-re tartja a két vezeték egymástól, a vezetékeket rugóval működő szorítóelem rögzíti.



RELEVANT STANDARD
MSZ 275

TB Tetőtartó bevezető

TRACON		L (mm)	W (mm)	D ₁ (mm)	D ₂ (mm)
TB-1.5	1,5"	115	110	34 (1,5")	33 × 41
TB-2	2"	115	110	44 (2")	33 × 41
TB-2.5	2,5"	115	110	58 (2,5")	33 × 41



A tetőtartó bevezető alkalmazásával lehetséges a 230/400 V-os kiefeszültségű légvezetési energiaelosztó hálózatról az épületek villamos energiaellátását biztosító szigetelt vezetékek sérülésmentes bevezetése az ún. tetőtartó acélcsővekbe. A bevezető egyúttal biztosítja, hogy az acélcsőbe a csapadék (eső, hó) ne kerülhessen be. A bevezető 1,5", 2" és 2,5" méretű acélcsővekhez készül. A két részből álló, műanyagból készült bevezető kúpos kiképzésű alsó része – további rögzítő eszköz nélkül – befeszül a megfelelő méretű acélcsőbe, felső része a vezetékek elhelyezése, bevezetése után csavarokkal rögzíthető az alsó részhez.





OLVASSA BE A KÓDOT!

- Nézze meg újdonságainkat
- Legyen naprakész

**Kínálatunk gyorsan és folyamatosan fejlődik!
Katalógusunk a 2021. áprilisi állapotot tükrözi.
Naprakész információért
látogasson el honlapunkra!**

IP védettségi fokozatok jelölése	N/2
Az alkalmazási kategóriák példái kisfeszültségű kapcsoló- és vezérlőkészülékekre	N/3
Körkeresztmetszetű rézvezetékek szabványos keresztmetszetei és vizsgálati áramok az IEC 60947-7-1 szerint.....	N/4
Időkésleltetési túlterhelésrelék működési határai minden pólus táplálása esetén.....	N/4
Szennyeződési fokozat.....	N/4
Meghúzási nyomatékok a csavartípusú csatlakozókapcsok mechanikai szilárdságának ellenőrzéséhez.....	N/5
Műanyagok égési tulajdonságai	N/5
A kisfeszültségű elosztóhálózatok típusai.....	N/6
Kábeljelölés	N/7
Hasznos tudnivalók a túlfeszültség-védelemről	N/8
Bekötési példák a TTV-típusú túlfeszültség-levezetők koordinált alkalmazására az egyes elosztóhálózatokban	N/9
Motorindító kombináció	N/10
Jelölések a villamos gyártmányokon.....	N/11
A szabványokról.....	N/12
Szabványjegyzék	N/13
Kódjegyzék	N/16
Tanúsítvány	N/26

IP védeettségi fokozatok jelölése

Az MSZ EN 60529:2015 szabvány részletes előírásokat ad az IP védeettségi fokozatok rendszerére, ezek követelményeire és vizsgálatára. A villamos gyártmányok szükséges védeettségi fokozatát mindig a vonatkozó termékszabványok határozzák meg, az MSZ EN 60529 előírásainak figyelembevételével.

Veszélyes részek érintése és idegen testek behatolása elleni védelem

Első szám	A védetség foka Megnevezés	Magyarázat
0	Nincs védelem	Feszültség alatt álló vagy mozgó alkatrészek véletlen érintése ellen nincs különösebb személyvédelem. Idegen szilárd testek behatolása ellen nincs védelem.
1	50 mm-es vagy nagyobb idegen testekkel szembeni védelem	Feszültség alatt álló alkatrészek és a belső mozgó gépelemek nagy felülettel, pl. kézfejjel történő véletlen érintése ellen van, de a védett alkatrészek és gépelemek szándékos megközelítésével szemben nincs védelem. 50 mm vagy annál nagyobb átmérőjű szilárd idegen testek behatolása elleni védelem.
2	12,5 mm-es vagy nagyobb idegen testekkel szembeni védelem	Feszültség alatt álló alkatrészek vagy a belső mozgó gépelemek ujjal történő érintése elleni védelem, 12,5 mm vagy annál nagyobb átmérőjű szilárd idegen testek behatolása elleni védelem.
3	2,5 mm-es vagy nagyobb idegen testekkel szembeni védelem	Feszültség alatt álló alkatrészek vagy a belső mozgó gépelemek szerszámmal, vezetékkel vagy 2,5 mm-es vagy annál vastagabb hasonló eszközökkel történő érintése elleni védelem. 2,5 mm vagy annál nagyobb átmérőjű szilárd idegen testek behatolása elleni védelem.
4	1 mm-es vagy nagyobb idegen testekkel szembeni védelem	Feszültség alatt álló alkatrészek vagy a belső mozgó gépelemek szerszámmal, vezetékkel, vagy 1 mm-es, vagy annál vastagabb hasonló eszközökkel történő érintése elleni védelem. 1 mm vagy annál nagyobb átmérőjű szilárd idegen testek behatolása elleni védelem.
5	Porlerakódás elleni védelem	Feszültség alatt álló vagy a belső mozgó alkatrészek érintése elleni teljes védelem. Védelem a káros porlerakódással szemben. A por behatolása nincs teljes mértékben megakadályozva, por azonban olyan mennyiségben nem hatolhat be, hogy károsan befolyásolni tudná a működőképességet vagy a biztonságot.
6	Por behatolása elleni védelem Porral szemben tömített	Feszültség alatt álló vagy a belső mozgó alkatrészek érintése elleni teljes védelem. Por behatolása elleni teljes védelem.

Víz behatolása elleni védelem

Második szám	A védetség foka Megnevezés	Magyarázat
0	Nincs védelem	Nincs különösebb védelem.
1	Függőlegesen csöpögő víz elleni védelem	A függőlegesen leeső vízcseppek nem okozhatnak károkat.
2	Csöpögő víz elleni védelem a tokozás max. 15°-os dőlése esetén	A függőlegesen leeső vízcseppek nem okozhatnak károkat, ha a tokozás a függőlegeshez képest mindkét irányban 15°-kal meg van döntve.
3	Vízpermet elleni védelem	A függőlegeshez képest mindkét irányból, max. 60°-os szögben permetezett víz nem okozhat károkat.
4	Fröccsenő víz elleni védelem	Bármely irányból a tokozásra fröccsenő víz nem okozhat károkat
5	Vízszög behatolása elleni védelem	Bármely irányból a készülékre irányított, fúvókából nyomással kilépő vízszög nem okozhat károkat.
6	Erős vízszög behatolása elleni védelem	Bármilyen irányból a készülékre irányított erős vízszög nem okozhat károkat.
7	Védelem az időszakos víz alá merítés hatásai ellen	A tokozásba nem hatolhat be veszélyes mennyiségű víz, ha a készüléket szabványban rögzített nyomással és ideig víz alá merítik.
8	Védelem tartós víz alá merítés hatásai ellen	A tokozásba nem hatolhat be veszélyes mennyiségű víz, ha a készüléket a gyártó és a felhasználó közti megállapodásban rögzített feltételek mellett tartósan víz alá merítik. A feltételeknek a 7. pontban rögzítetteknél szigorúbbnak kell lenniük.
9	Védelem nagynyomású vízzel, vagy gőzzel történő tisztítás esetén	Bármely irányból igen erős nyomással a tokozásra irányított víz vagy gőz nem okozhat károkat. Víznyomás: 100 bar Vízhőmérséklet: 80 °C.

**Az alkalmazási kategóriák példái
kisfeszültségű kapcsoló- és vezérlőkészülékekre**

Áramnem	Kategória	Jellemző alkalmazások	A vonatkozó IEC termékszabvány
Váltakozó áram	AC-1	Nem induktív vagy csekély mértékben induktív terhelések, ellenállás-fűtésű kemencék	60947-4
	AC-2	Csúszógyűrűs motorok: indítás, kikapcsolás	
	AC-3	Kalickás motorok: indítás, motorok kikapcsolása forgás közben	
	AC-4	Kalickás motorok: indítás, ellenáramú fékezés ¹⁾ , léptetés ²⁾	
	AC-5a	Villamos kisülőlámpa-vezérlés kapcsolása	
	AC-5b	Izzólámpák kapcsolása	
	AC-6a	Transzformátorok kapcsolása	
	AC-6b	Kondenzátortelepek kapcsolása	
	AC-7a	Csekély mértékben induktív terhelések háztartási készülékeknél és hasonló alkalmazásokban	61095
	AC-7b	Motorterhelések háztartási alkalmazások számára	
	AC-8a	Hermetikus hűtőkompresszorok motorvezérlése a túlterheléskioldók kézi visszaállításával	60947-4
	AC-8b	Hermetikus hűtőkompresszorok motorvezérlése a túlterheléskioldók önműködő visszaállításával	
	AC-12	Ellenállás-terhelések és optocsatolókkal elszigetelt szilárdtestterhelések vezérlése	60947-5
	AC-13	Transzformátoros elszigetelésű szilárdtestterhelések vezérlése	
	AC-14	Kis elektromágneses terhelések vezérlése	
	AC-15	Váltakozó áramú elektromágneses terhelések vezérlése	
	AC-20	Terhelésmentes feltételek melletti zárás és leválasztás	60947-3
	AC-21	Ellenállás-terhelések kapcsolása, a mérsékelt túlterheléseket beleértve	
AC-22	Kevert, ellenállás- és induktív jellegű terhelések kapcsolása, a mérsékelt túlterheléseket beleértve		
AC-23	Motorterhelések vagy más erősen induktív terhelések kapcsolása		
Váltakozó és egyenáram	A	Áramkörök védelme, névleges rövid idejű határáram-érték megadása nélkül	60947-2
	B	Áramkörök védelme, névleges rövid idejű határáram-érték megadásával	
Egyenáram	DC-1	Nem induktív vagy csekély mértékben induktív terhelések ellenállásfűtésű kemencék	60947-4
	DC-3	Söntmotorok indítása, ellenáramú fékezése ¹⁾ , léptetése ²⁾ , motorok dinamikus fékezése	
	DC-5	Soros motorok indítása, ellenáramú fékezése ¹⁾ , léptetése ²⁾ , motorok dinamikus fékezése	
	DC-6	Izzólámpák kapcsolása	
	DC-12	Ellenállás-terhelések és optocsatolókkal elszigetelt szilárdtestterhelések vezérlése	60947-5
	DC-13	Egyenáramú elektromágnesek vezérlése	
	DC-14	Áramköri takarék-ellenállással ellátott egyenáramú elektromágneses terhelések vezérlése	
	DC-20	Terhelésmentes feltételek melletti zárás és leválasztás	60947-3
	DC-21	Ellenállás-terhelések kapcsolása a mérsékelt túlterheléseket beleértve	
	DC-22	Kevert, ellenállás- és induktív jellegű terhelések kapcsolása a mérsékelt túlterheléseket beleértve (pl. söntmotoroké)	
DC-23	Erősen induktív terhelések kapcsolása (pl. soros motoroké)		

¹⁾ Ellenáramú fékezés alatt a motor primer csatlakozásainak forgás közbeni megcserélésével a motor megállítását vagy a forgásirányának gyors megváltoztatását kell érteni.

²⁾ Léptetés alatt – a hajtott mechanizmus kis elmozdulásának elérése céljából – a motornak egyszeri vagy ismételt rövid időszakokra való táplálását kell érteni.

Körkeresztmetszetű rézvezetékek szabványos keresztmetszetei és vizsgálati áramok az IEC 60947-7-1 szerint

ISO keresztmetszet (mm ²)	AWG/MCM		Vizsgálati áramok (A)
	Méret	Egyenértékű keresztmetszet (mm ²)	
0,2	24	0,205	4
-	22	-	
0,5	20	0,519	6
0,75	18	0,82	9
1	-	-	13,5
1,5	16	1,3	17,5
2,5	14	2,1	24
4	12	3,3	32
6	10	5,3	41
10	8	8,4	57
16	6	13,3	76
25	4	21,2	101
35	2	33,6	125
50	0	53,5	150
70	00	67,4	192
95	000	85	232
-	0000	107,2	
120	250MCM	127	269
150	300MCM	152	309
185	350MCM	177	353
240	500MCM	253	415
300	600MCM	304	520

Időkésleltetéses túlterhelésrelék működési határai minden pólus táplálása esetén

A túlterhelésrelé típusa	Az árambeállítási érték többszöröse				Referencia környezeti hőmérséklet
	A	B	C	D	
Termikus típus, kompenzált a környezeti hőmérséklet változására	1,05	1,2	1,5	7,2	+ 20 °C
	Kioldási idő				Kioldási osztály
Indítás	hideg állapotból	meleg állapotból	meleg állapotból	hideg állapotból	
Kioldás	nem történhet 2 órán belül	2 órán belül ki kell oldani	< 2 min	2...10 s	10A
			< 4 min	4...10 s	10
			< 8 min	6...20 s	20
			< 12 min	9...30 s	30

Szennyeződési fokozat

Olyan egyezményes szám, amely vezető vagy higroszkópikus por, ionizált gáz vagy só mennyiségén és a relatív légnedvességen, valamint ezek előfordulási gyakoriságán alapul, amelyek a higroszkópikus abszorpció vagy a légnedvesség-lecsapódás következtében a villamos szilárdság és/vagy a felületi ellenállás csökkenéséhez vezetnek.

Szennyeződési fokozat	Magyarázat
1	Nincs szennyeződés, vagy csak száraz, nemvezető szennyeződés lép fel.
2	Rendszeren csak nemvezető szennyeződés lép fel. Esetenként azonban a páralecsapódás által okozott átmeneti vezetőképességre lehet számítani.
3	Vezető szennyeződés keletkezik, vagy száraz, nemvezető szennyeződés lép fel, amely a páralecsapódás következtében vezetővé válik.
4	A szennyeződés állandó vezetőképességet hoz létre, például vezető por, eső vagy hó által.

Amennyiben a vonatkozó termékszabvány eltérően nem rendelkezik, az ipari alkalmazásokra szánt készülékeket általában a 3. szennyeződési fokozat, a háztartási és hasonló alkalmazásokra szánt készülékeket általában 2. szennyeződési fokozat szerinti környezetben használják.

Meghúzási nyomatékok a csavartípusú csatlakozókapcsok mechanikai szilárdságának ellenőrzéséhez

Menetátmérő (mm)		Meghúzási nyomaték (Nm)		
Szabványos metrikus értékek	Átmérőtartomány	L	II.	III.
2,5	2,8-ig	0,2	0,4	0,4
3,0	2,8 – 3,0	0,25	0,5	0,5
-	3,0 – 3,2	0,3	0,6	0,6
3,5	3,2 – 3,6	0,4	0,8	0,8
4	3,6 – 4,1	0,7	1,2	1,2
4,5	4,1 – 4,7	0,8	1,8	1,8
5	4,7 – 5,3	0,8	2,0	2,0
6	5,3 – 6,0	1,2	2,5	3,0
8	6,0 – 8,0	2,5	3,5	6,0
10	8,0 – 10	-	4,0	10,0
12	10 – 12	-	-	14,0
14	12 – 15	-	-	19,0
16	15 – 20	-	-	25,0
20	20 – 24	-	-	36,0
24	24 felett	-	-	50,0

I: Hernyócsavarok, amelyek meghúzáskor nem állnak ki a furatból

II: Anyák és csavarok, melyet csavarhúzóval húznak meg.

III: Anyák és csavarok, melyet más szerszámmal húznak meg.

Műanyagok égési tulajdonságai

A műanyagok éghetőségi vizsgálatait az Underwriters Laboratories (USA) az UL 94 előírásban határozza meg. Ez az összes alkalmazási területre érvényes. Egy vízszintes- ill. függőleges teszt során a műanyag alapanyag égési viselkedését vizsgálják a laboratóriumban nyílt láng hatására. A besorolási osztályok növekvő lángállósági tulajdonsággal a HB, V1, V2, V0 és 5V osztályok.

HB (Horizontal Burn)

Ennél a tesztnél a vizsgálandó terméket vízszintesen tartva az egyik végénél meggyújtják. Az égési sebességnek nem szabad a 76mm/perc (3 mm-es anyagvastagság felett 38 mm/min) értéket túllépnie.

V2-V0 (Vertical Burn)

Ennél a tesztnél a vizsgálandó terméket függőlegesen tartva az alsó végénél gyújtják meg. Így ez a teszt szigorúbb, mint a UL 94HB.

V2

Önkioltó legkésőbb 30 másodpercen belül. Az égő csepp megengedhető.

V1

Önkioltó legkésőbb 30 másodpercen belül. Az égő csepp nem megengedhető, utánizzás max. 60 másodpercig.

V0

Önkioltó legkésőbb 10 másodpercen belül. Az égő csepp nem megengedhető, utánizzás max. 30 másodpercig.

5V

Szigorított lángállósági vizsgálat. A függőlegesen vizsgálandó testet 5-ször mindig 5 perc hosszan egy 127 mm hosszú lángnyelvbe helyezzük. Az utolsó vizsgálat után utánégés és égő csepp nem megengedhető, utánizzás max. 60 másodpercig.

5VA

Ugyanaz, mint az 5VB teszt, de égési lyuk nem engedhető meg.

5VB

Ugyanaz, mint az 5V teszt, de a vizsgálandó test vízszintes. Égési lyuk a láng kialakása után megengedhető.

A kisméretű elosztó-hálózatok típusai

Az elosztóhálózat kapcsolata a földdel

- 1. betű: **T** - egy ponton közvetlenül földelt
I - a földtől elszigetelt vagy impedancián keresztül földelt
- 2. betű: **T** - a testek közvetlenül csatlakoznak a földhöz
N - a testek közvetlenül csatlakoznak az energiaellátó rendszer földelt pontjához
- További betűk: **S** - a védelmi feladatot külön védővezető látja el
C - a nullavezető és a védővezető közös: PEN-vezető

A betűk magyarázata:

- T:** terre - föld
- N:** neutral conductor - nullavezető
- I:** insulated / impedance - szigetelt / impedancia
- S:** separated - elválasztott, elkülönített
- C:** common - közös
- PE:** protectiv earth conductor - védővezető, kizárólag hibaáram vezetésére
- PEN:** a védő- és a nullavezető együttes alkalmazása (PE+N)

A rajzokon szereplő jelölések:

- TR.SEC:** az elosztóhálózati transzformátor szekunder tekercsei
- L1, L2, L3:** a fázisvezetők jelölése
- U, V, W:** a fogyasztókészülék csatlakozókapcsai
- : fázisvezető, nullavezető
- . — . — : védővezető

TN- rendszer (nullázott rendszer)

A TN- rendszerek egyik pontja közvetlenül földelt, a fogyasztóberendezések testjei ehhez a ponthoz csatlakoznak védővezetővel.

A TN- rendszer típusai: **TN-C, TN-C-S, TN-S**

Fontos: a már szétválasztott PE és N vezetőt nem szabad újból összekötni és az áramvédőkapcsoló után sem szabad PEN vezetőt alkalmazni – ugyanis ez esetben az áramvédőkapcsoló működésképtelenné válik!

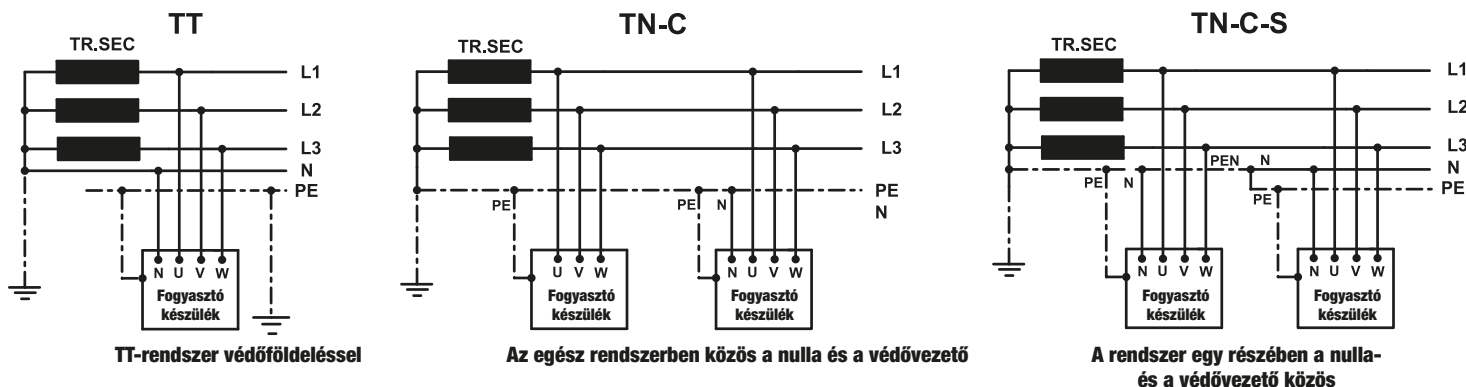

TT- rendszer (földeléses rendszer védőföldeléssel)

Az elosztórendszer egyik pontja közvetlenül földelt, a fogyasztókészülékek testjei az elosztórendszer földelőitől független földelőkhöz közvetlenül csatlakoznak.

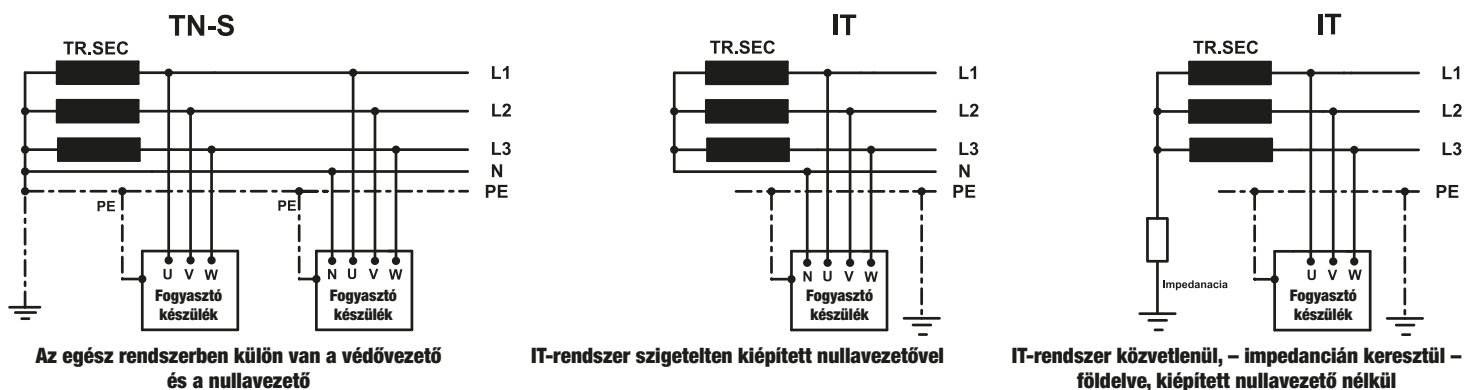

IT-rendszer (szigetelt rendszer védőföldeléssel)

Az elosztórendszer egyik pontja impedancián keresztül földelt vagy minden aktív rész el van szigetelve a földtől, a fogyasztókészülékek testjei földeltek (egyenként, csoportosan vagy együttesen csatlakoznak a földelési rendszerhez). A földelt védővezető kiépítése kötelező, a nullavezetőt vagy kiépítik vagy nem. Egyetlen test- vagy földzárlat fellépésekor kicsi hibaáram esetén nem feltétlen szükséges a lekapcsolás. Az aktív rész és a testek vagy a föld közötti első hibát jelezni kell. Az első hiba fellépése után a második hiba bekövetkezésekor a hibás berendezést meghatározott időn belül le kell kapcsolni.

Kábeljelölés**SZABVÁNYJELZÉS**

Szabványosság jelölése
Elfogadott nemzeti típus

H**A****NÉVLEGES FESZÜLTÉG**

100/100 V alatt
100-300 V-ig
300/300 V
300/500 V
450/750 V

00**01****03****05****07****ÉRSZIGETELÉS**

PVC
Természetes gumi
Szilikongumi
Üvegszövet
Papír
Térhálósított polietilén

V**R****S****J****P****X****ÁRNYÉKOLÓRÉTEG**

Alumínium
Réz
Acél
Ón
Ólom
Erek közös páncélozása

A**C****F****K****L****D****KÖPENYSZIGETELÉS**

PVC
Textilszövet
Szilikongumi
Természetes gumi
Polikloroprén
Üvegszövet
Műgumi
Polietilén

V**T****S****R****N****J****B****E****SPECIÁLIS FELÉPÍTÉS**

Belső kialakítás
Kábelalak

D**H****ÉR ANYAGA**

Réz
Alumínium
Speciális anyag

...

A**Z****ÉRSZERKEZET**

Extra hajlékony
Különösen hajlékony
Sodrott, kör elemi szálak
Sodrott, szektor elemi szálak
Tömör
Tömör, szektor elemi szálak

F**H****R****S****U****W****ÉRSZÁM**

...

VÉDŐVEZETŐ

Nem tartalmaz védővezetőt
Tartalmaz védővezetőt

X**G**

Hasznos tudnivalók a túlfeszültség-védelemről

Az épületek villámcsapásokból származó, elsősorban éghető szerkezeti elemeinek tűzvédelmére szolgáló, villámhárítóval megvalósított külső villám-védelme nem jelenti egyúttal az épületben üzemeltetett villamos fogyasztók és berendezések villámcsapásokból származó, közvetett túlfeszültségvédelmét is. Ha egy külső villámvédelemmel rendelkező épületet közvetlen villámcsapás ér, akkor a villámhárító földelési ellenállásán olyan feszültségnövekedés jön létre, amely a távoli környezethez képest túlfeszültséget jelent. Ez a potenciálemelkedés megjelenik az épülethez csatlakozó villamos rendszerekben (pl. telefonhálózat, kábel TV, kiefeszültségű hálózat), veszélyeztetve azokat. A túlfeszültségvédelem célja a közvetlen vagy közvetett villámcsapások által okozott (SEMP) vagy főképp induktív jellegű terhelések kikapcsolásából származó kapcsolási túlfeszültségek korlátozása (LEMP). Az impulzusok és a túlfeszültség-levezető készülékek csoportosítását az MSZ EN 61643-11 és MSZ EN 62305 szabványoknak megfelelően az alábbi táblázat mutatja:

Impulzusalak	10/350 µs	8/20 µs
Impulzus keletkezése	Villámimpulzus: a villámcsapás hatására keletkező lökőáram leképezése	Túlfeszültségimpulzus: pl. kapcsolási jelenség leképezése, távoli villámcsapás hatása
Jellemzők	Nagy töltés- és energiatartalmú impulzus, hosszú időtartammal	Gyors felfutású impulzus, viszonylag alacsony energiatartalommal
Készüléktípus	1. típusú levezetők	2. típusú levezetők 3. típusú levezetők
	1. típusú + 2. típusú kombinált levezetők	

LPZ villámvédelmi védőzónarendszer

Az 1. típusú túlfeszültség-levezetőket az épületek főelosztóiban célszerű elhelyezni, közvetlenül a fogyasztásmérő utáni hálózatszakasban. Ezek az eszközök így az LPZ1, vagy ritkább esetekben az LPZ0 villámvédelmi zónában kerülnek beszerelésre, ezért a 10/350 ms villámimpulzus levezetésére tervezik őket. A 2. típusú túlfeszültség-levezetők az épületek alelosztóiban, vagy lakáselosztókban kerülnek beszerelésre, ezzel az alkalmazással az LPZ2 villámvédelmi zónába kerülnek. A 3. típusú túlfeszültség-levezetőket célszerű a védendő berendezéshez minél közelebb elhelyezni. Mivel a védendő berendezéseket általában az épületek belsejében használják, ezért az LPZ2, vagy LPZ3 villámvédelmi zónában helyezkednek el. A kombinált 1+2 típusú levezetőket általában utólagosan ugyancsak az alelosztóba telepítik, így az LPZ2 zónába kerülnek. Az LPZ2 és LPZ3 zónákba szerelt 2., 3. és 1+2 típusú készülékek a 8/20 ms túlfeszültségimpulzus levezetésére szolgálnak.

Az ismertett többlépcsős védelmi rendszer készülékei a védendő vezető és a föld között párhuzamosan vannak kapcsolva. A működés ezért ún. fordított módon következik be, azaz a helyesen méretezett védelmi rendszerben mindig hátulról indul és előre halad. A földhöz és a vezetőkhöz képest egymással párhuzamosan kötött levezetők közül elsőként a finomvédelmi, azaz a 3. típusú védőkészülék kezd el levezetni.

Ha kellően nagy energiájú impulzust kell levezetni, akkor a 2. és 3. típusú levezetők között lévő vezeték szakasz impedanciáján fellépő feszültség hozzáadódik a 3. típusú védőkészülék védelmi szintjének megfelelő feszültséghez, az eléri az előtte lévő 2. típusú levezető védelmi szintjét, minek következtében az is elkezd levezetni a föld felé. Ezután hasonló elvek alapján az 1. típusú villámáram levezető is működésbe lép, és levezetni kezd. Kisebb energiájú impulzusok fellépése esetén azonban csak a 3. típusú és a 2. típusú védőkészülékek működnek, és a villámáram levezető (1. típus) nem is gyűjt be. A leírt működés létrejöttének feltétele az egyes védőkészülékek, különösen az 1. típusú és a 2. típusú levezetők közötti vezeték szakasz kellő nagyságú impedanciája. Erre általában egy 10 – 15 m hosszúságú vezeték impedanciája elegendő. Több esetben azonban, pl. helyhiány, vagy az elosztók kis távolsága következtében a javasolt vezeték szakasz nem alakítható ki. Ebben az esetben ún. csatolófojtónak a két védőkészülék közötti soros kapcsolású beépítésére van szükség.

A fentiekből következően a beépítendő készülékek lépcsőzetesen csökkenő védelmi szintjeit és az adott vezeték szakaszon várható (méretezési) lökőfeszültség értékét összevetve ellenőrizni kell, hogy az egyes készülékek feszültségvédelmi szintje a készülék utáni szakasz lökőfeszültség határértéke alá korlátozza-e az ott fellépő vezetett túlfeszültségimpulzusok csúcsértékét. Szintén ellenőrizni kell azt is, ha a készüléket az LPZ zónahatáron építik be, akkor képes-e az ott fellépő szabványos impulzust levezetni, és alkalmas-e a villámvédelmi zóna potenciál kiegyenlítésére.

Zárlatvédelem működésekor vagy a hálózaton végrehajtott kapcsolási műveletek következményeként fellépő túlfeszültségek, valamint távoli villámcsapások által indukált túlfeszültségek ellen sok esetben a 3. típusú védőkészülék önmagában is védelmet nyújt a fázis, nulla és védőföld között. Nagyobb energiatartalmú impulzusok esetén (közvetlen villámcsapás, nagyteljesítményű fogyasztók be- ill. kikapcsolása, stb.) az 1. és 2. típusú védőkészülékek hiányában a finomvédelmi készülék túlterhelődhet és tönkremehet. Mindig célszerű ezért a többlépcsős védelmet megvalósítani, és ügyelni kell az LPZ villámvédelmi és az SPZ kapcsolási túlfeszültségzóna-rendszerben alkalmazott védőkészülékek várható impulzus igénybevételeinek nagyságára, a többlépcsős védelem megfelelő koordinációjára, továbbá a felhasznált védőkészülékek beépítési feltételeinek pontos betartására.

Bekötési példák a TTV-típusú túlfeszültség-levezetők koordinált alkalmazására az egyes elosztóhálózatokban

A TN-C típusú hálózat

1. típus (B) levezető telepítése a mért hálózatra

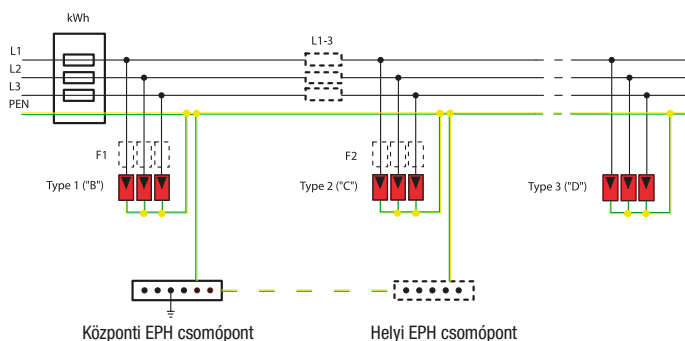

TN-C-S típusú hálózat

Ha az 2. típus (C) levezető közelebb van a EPH-hoz, mint 0,5 m

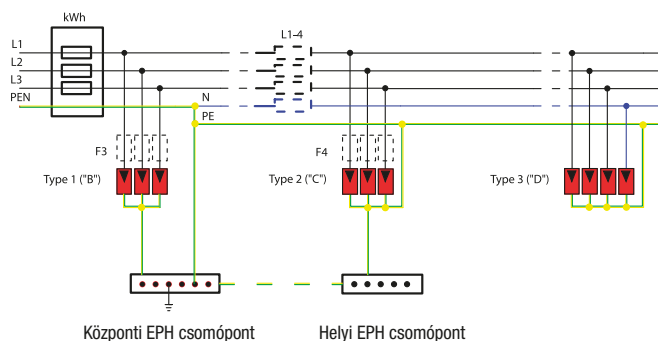

TN-C-S típusú hálózat

Ha az 2. típus (C) levezető messzebb van a EPH-től 0,5 m-nél

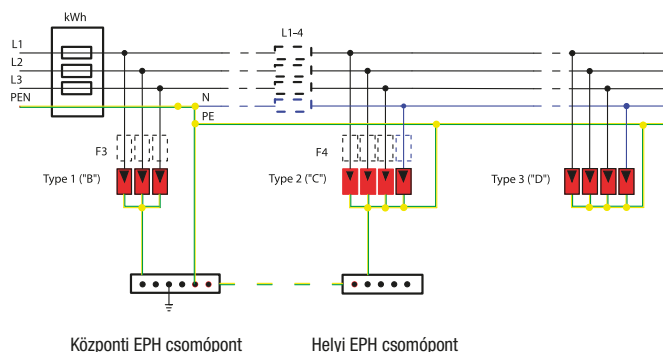

TN-S típusú hálózat

1. típus (B) levezető telepítése a mért hálózatra

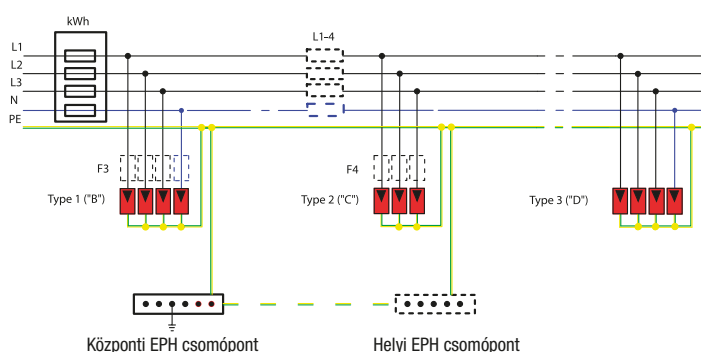

A többlépcsős védelmi rendszer kialakításához több szempontot is figyelembe kell venni.

A legfontosabb szempontok az alábbiak:

Az épület elhelyezkedése

Egyedülálló, vagy

Teleszerűen sorban álló vagy házak közé zárt;

Az épület magassága

10m alatt;

30m alatt, vagy

30m és annál magasabb;

Az épület rendelkezik-e külső villámvédelemmel;

A közcélú légvezetéki hálózat kialakítása

Szigetelt vezetékkel, vagy

Szigeteletlen sodronnyal;

Az épület hálózati csatlakozóvezetékének kialakítása:

Földkábel, vagy

Légvezeték, ezen belül

Szigetelt vezetékkel, vagy

Szigeteletlen sodronnyal

Magyarországon, de Európa több más országában is legnagyobb számban teleszerűen, a házak között sorban, ill. zártan elhelyezkedő, 10m vagy annál alacsonyabb, külső villámvédelemmel nem rendelkező, szigetelt vezetékű közcélú hálózatra földkábelrel, esetleg szigetelt vezetékkel csatlakozó épületek találhatóak.

Több, a témában jártas szakértő egybehangzó véleménye szerint a fenti szempontokat figyelembe véve csoportosítható épületek vannak a legkevésbé kitéve a közvetlen villámcsapás bekövetkezésének, azaz biztonságosnak tekinthetők. Ez azt jelenti véleményük szerint, hogy ezekben az épületekben nincs szükség az 1. típusú villámáram-levezetők alkalmazására, elégséges a 2. típusú túlfeszültség-levezetőktől a készülékek beépítése a főelosztóba. Természetesen a fenti jellemzőktől csak egy tekintetben is eltérő esetekben mindig szükséges a teljes, háromlépcsős védelmi rendszer kiépítése.

Motorindító kombináció

A TR1D- ... - típusú kontaktorok, segédérintkezők, időzítő vagy időrelé, valamint hőrelé felhasználásával különböző kombinációk alakíthatók ki, így pl. a csillag-delta automata motorkapcsoló ill. motorindító. A rövid ismertető tervezési segédletet nyújt a szükséges elemek összerendeléséhez, kapcsolási rajzuk, huzalozásuk, bekötési kialakításhoz.

A csillag-delta motorindító 3 kontaktorból, 2 segédérintkezőből, 1 időzítőegységből és 1 hőreléből áll.

Csillag-delta indítás

A csillag – delta-indítás az egyik leggyakrabban használt indítóegység. Bekapcsoláskor a motor csillagban indul, ezáltal a motor tekercsre jutó feszültség a névleges érték $\sqrt{3}$ -a. Az indítás pillanatában az áramfelvétel csak 2...2,5-szeres és ennek következtében a motor indítónyomatéka a direkt indításnál kifejtett érték harmadára csökken, mivel a motor nyomatéka a feszültség négyzetével arányos. Tehát az indítónyomaték a névleges motornyomaték 0,3...0,7-szerese, a kivittől és a típustól függően. Delta üzemmódban pedig a motor rendelkezésére áll a teljes forgatónyomaték.

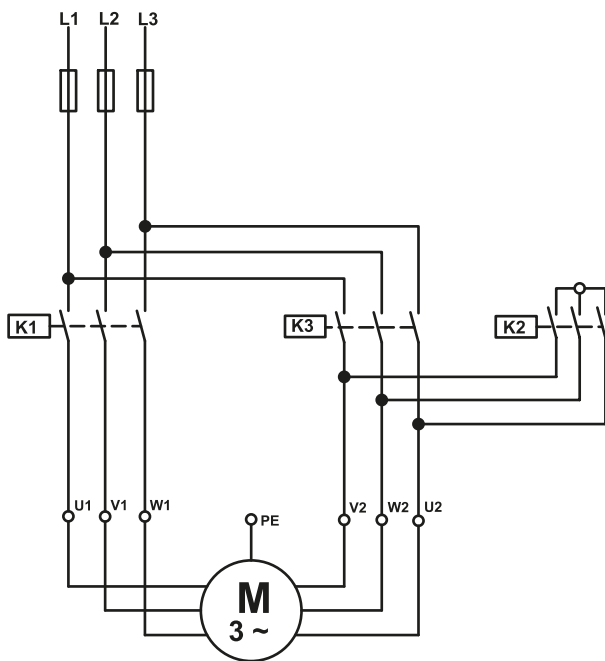

Főáramkör kapcsolási rajza

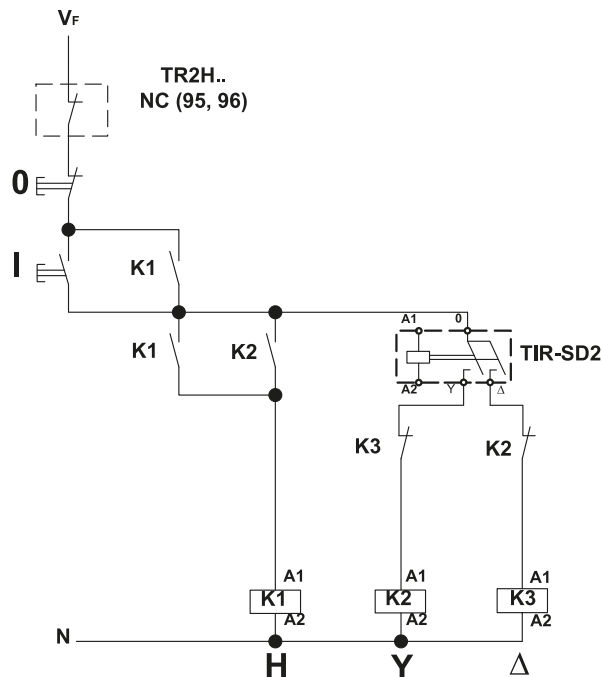

Vezérlőáramkör kapcsolási rajza

A működés leírása

























Az „I” nyomógomb működteti az időrelét. Amikor behúzz, akkor a Y – kapcsolás érintkezője zár és a motort csillagba kapcsolja, ezáltal a motor elindul. Az időrelén beállított idő végén a Y – kapcsolás érintkezője elenged és a Delta-kapcsolás érintkezője pedig meghúzz, ezáltal a motorra kapcsolja a teljes hálózati feszültséget. Az átváltás kapcsolási ideje kb 500-600 ms, mely alatt a csillag-és a deltakapcsolás érintkezője ki van kapcsolva.

Kontaktorkok, hőrelék, időzítő, segédérintkezők összerendelési példái:

Max. motor-teljesítmény	4 kW	9 kW	18 kW	22 kW	30 kW	45 kW
Kontaktor	3 db TR1D0910	2 db TR1D1810 1 db TR1D1210	2 db TR1D4010 1 db TR1D3210	3 db TR1D5011	2 db TR1D6511 1 db TR1D5011	2 db TR1D9511 1 db TR1D6511
Hőrelé	TR2HD1314	TR2HD1321	TR2HD3353	TR2HD3357	TR2HD3361	TR2HD3365
Időzítőegység	TIR-SD2/TIR-SD3	TIR-SD2/TIR-SD3	TIR-SD2/TIR-SD3	TIR-SD2/TIR-SD3	TIR-SD2/TIR-SD3	TIR-SD2/TIR-SD3
Segédérintkező	TR8-DN11	TR8-DN11	TR8-DN11	-	-	-

Jelölések a villamos gyártmányokon



Adattáblán vagy a termékeken alkalmazott jelek

	Váltakozó áram
	Egyenáram
	Háromfázisú váltakozó áram
	Háromfázisú váltakozó áram, nullavezetővel
	II. érintésvédelmi osztályú eszköz
	III. érintésvédelmi osztályú eszköz
	A biztonságos működtetéshez a kezelési útmutató tudnivalóit is figyelembe kell venni
	Csak szinuszos váltakozó áramú hibaáramokra érzékeny áram-védőkapcsoló
	Lüktető egyenáramú összetevőjű váltakozó áramú hibaáramokra érzékeny áram-védőkapcsoló
	Egyen és váltakozó áramra érzékeny áram-védőkapcsoló
	Névleges zárlati megszakítóképesség az alkalmazandó előtétbiztosító értékének megadásával
	Környezeti hőmérséklet-tartomány alsó értéke
	Kismegszakító névleges zárlati megszakítóképessége és energiakorlátozó osztálya (I ² t)
	Izzólámpa-terhelés
	Fénycsőterhelés
	Motoros terhelés
	Törpefeszültségű biztonsági elválasztó transzformátor
	Elektronikus konverter kifeszültségű izzólámpák (pl. halogénlámpák) számára
	Vasmagos transzformátor kifeszültségű izzólámpák (pl. halogénlámpák) számára
	Közvetlen nyitási működésű vezérlőkapcsoló
	Függőleges helyzetben használható
	Vízszintes helyzetben használható
	Ferde, pl. 60°-os helyzetben használható
	HAR-jel kábelek és vezetékek számára
	Áramütés veszélyére történő figyelmeztetés
Ex, Rb	Robbanásbiztos gyártmány
AX	Fénycsőterheléses áram
m	Kis érintkezésű kialakítás
mikro	Mikró érintkezésű kialakítás
T	Környezeti hőmérséklet

Kapcsolók jelzései

I Be On	Bekapcsolt állás
0 Ki Off	Kikapcsolt állás
	Leválasztásra alkalmas kapcsoló
	Tartós be
	Késleltetési idő

Kapcsok jelölései

	Érintésvédelmi védővezető csatlakozókapcsa
	Üzemi földelés csatlakozókapcsa
	Csatlakozókapocs szabályozott terheléshez
L1, L2, L3,	Háromfázisú hálózat fázisvezetői
U, V, W	Háromfázisú fogyasztó csatlakozókapcsai
L1, L2	Egyfázisú villamos termék potenciálfüggetlen csatlakozókapcsai
N	Nullavezető-kapocs
PEN	Nullavezetővel egyesített védővezető kapocs
A1, A2	Működtetőtekerecs csatlakozókapcsai
X1, X2	Jelzőlámpák csatlakozókapcsai
1-10	Főérintkezők csatlakozókapcsai
..1, ..2	Nyitó segédérintkező csatlakozókapcsai
..3, ..4	Záró segédérintkező csatlakozókapcsai
95, 96	Túlterhelésvédelmi készülék nyitó reléérintkezője
97, 98	Túlterhelésvédelmi készülék záró reléérintkezője
X, Y, Z	Belső kötésre alkalmas csatlakozókapcsok
mm² vagy Δ	A kapocsba csatlakoztatható vezeték mérete

A biztonsági és műszaki követelményeket meghatározó, illetve e célból intézkedéseket előíró szabványokat általában három csoportra oszthatjuk:

A) A katalógusunkban szereplő termékek mellett fel van tüntetve a rájuk vonatkozó szabvány. Ezek ún. **termékszabványok**, amelyek az adott árucikkre, készülékre vonatkozó biztonsági, szerkezeti, minőségi és vizsgálati követelményeket tartalmazzák. E szabványok alapos ismerete elsősorban az adott termék konstruktőrének, gyártójának és vizsgáló személyzetének szükséges. A termékek felhasználójának elegendő azt tudni, hogy a termék a vonatkozó szabványoknak megfelelően készült és kielégíti e szabványok biztonsági és műszaki követelményeit. Ezt a gyártó vagy a forgalmazó írásban is deklarálja: a **79/1997. (XII.31.)** IKIM rendelet szerinti „**MEGFELELŐSÉGI NYILATKOZAT**”-ban, amelyet az általa lefolytatott megfelelőség értékelési eljárás pozitív eredménye alapján állít ki.

A TRACON által forgalmazott villamosipari termékeket általában kétféle módon lehet felhasználni:

Előregyártott kismegszakító elosztó- kapcsoló és vezérlő berendezésekbe vagy más villamos szerkezetbe, készülékbe építik be, pl. ipari jellegű alkalmazásra. Ez esetben az újonnan összeszerelt berendezés vagy készülék is általában terméknek minősül, amelyet az **MSZ EN 61439** szabványsorozat vagy más, az adott szerkezetre vonatkozó termékszabvány figyelembevételével kell a gyártónak elkészíteni és vizsgálni, majd a gyártónak, forgalmazónak Megfelelőségi Nyilatkozatot kell szolgáltatni.

B) A helyszínen szerelt különféle villamos berendezések létesítése során építik be a termékeinket, pl. ipari vagy lakóépületek villamos berendezéseinek szerelésekor (ún. installációs felhasználás). Ez esetben a felhasználónak az ún. létesítési szabványok előírásait kell követni.

Az új villamos berendezések létesítésekor korábbi magyar szabványok: (MSZ 1600, MSZ 1610 és MSZ 172 sorozatok) helyett az **MSZ 2364/MSZ HD 60364** jelű szabványsorozat követelményeit kell figyelembe venni, amely 2003 óta érvényes. A sorozat az **IEC 60364** nemzetközi szabványsorozat, illetve a **HD 384** európai harmonizációs dokumentum alapján készült. A szabványsorozat címe: **Kisfeszültségű villamos berendezések**. A szabványsorozatot kiegészítik a robbanóképes közegeket tartalmazó térségek esetében alkalmazandó (MSZ EN 60079), továbbá a villámvédelemmel (MSZ EN 62305), a kábelfektetéssel (MSZ 13207) stb. foglalkozó szabványok és a következő (jelenleg, 2020. júniusában hatályos) jogszabályok:

- **54/2014. (XII.5.) BM** rendelet az Országos Tűzvédelmi Szabályzatról (**OTSZ**),

- **40/2017. (XII. 4.) NGM** 40/2017. (XII. 4.) NGM rendelet az összekötő és felhasználói berendezésekről, valamint a potenciálisan robbanásveszélyes közegben működő villamos berendezésekről és védelmi rendszerekről.

Ezek szintén tartalmaznak a létesítéssel kapcsolatos előírásokat.

C) A szabványok harmadik csoportjába **magatartási és biztonsági szabályokat rögzítő; vagy eljárási rendeket, rendszereket szervező szabványok** tartoznak. Ilyen szabvány pl. az MSZ EN ISO 9001 szabvány, amely a minőségirányítási rendszerekkel foglalkozik. A villamos szakemberek számára e témakörből a legfontosabb az **MSZ 1585** jelű, Villamos berendezések üzemeltetése című szabvány. A szabvány a villamos berendezések üzemeltetésére, illetve a villamos berendezések vagy azok közelében végrehajtott munkavégzésre vonatkozik. Követelményeket határoz meg a biztonságos üzemeltetésre, a személyzetre, a munkavégzési és karbantartási eljárásokra, egyes különleges munkákra, a műszaki mentésre és az elsősegélynyújtásra.

Végül a szabványok alkalmazásáról: a módosított **1995 évi XXVIII.** törvény szerint Magyarországon **a nemzeti szabvány alkalmazása önkéntes.**

A szabványok önkéntes alkalmazási lehetősége látszólag szabadságot ad a szabványalkalmazónak, de ez a szabadság fokozott felelősséggel jár. A szabványok nem alkalmazása vagy a szabványtól való eltérés esetén is a vonatkozó szabványokban meghatározottakkal legalább egyenértékű műszaki megoldással kell a biztonsági szintet fenntartani. Ezt a szabványtól eltérőnek igazolnia kell és teljes mértékben felelnie kell érte. A szabványok önkéntes alkalmazása lehetővé teszi azt, hogy visszavont szabványokat is alkalmazhatunk. A visszavont szabványok nincsenek érvényben, de továbbra is alkalmazhatók, pl.:

- a korábban gyártott termékek, illetve létesített berendezések biztonsági megfelelőségét ezek alapján lehet elbírálni,
- új gyártmányok és új létesítmények esetében is megegyezhet a megrendelő és a kivitelező arról, hogy nem az érvényes, hanem az évszámmal is megjelölt, az adott területre vonatkozó szabvány legutolsó érvényes vagy a visszavont kiadását alkalmazzák,
- sok esetben az új európai létesítési szabványok nem tartalmaznak egyes előírásokat, vagy nem olyan részletesek, mint a már visszavont, régebbi magyar szabványok. Ekkor is célszerű, sőt szükséges a visszavont szabványok ilyen előírásainak alkalmazása, ha nem ellentétesek az új előírásokkal – ez is a biztonsági szint fenntartását segíti.

EN 12275	Hegymászó felszerelések. Karabinerek. Biztonsági követelmények és vizsgálati módszerek
EN 13411	Acélsodronykötél-végek. Biztonság
EN 20898-7.....	Kötőelemek mechanikai tulajdonságai. 7. rész: Az 1 mm-10 mm névleges méretű csavarok csavaróvizsgálata és legkisebb törőnyomatéka
EN 50262	Metrikus kábeltömszelencék villamos berendezésekhez
EN 50461	Napelemek. Adatlapok és gyártmányadatok kristályos szilícium napelemekhez
EN 50513	Napelemlapkák. Napelemgyártáshoz használatos kristályos szilíciumlapkák adatlapja és terméktájékoztatója
EN 50521	Fotovillamos rendszerek csatlakozói. Biztonsági követelmények és vizsgálatok
EN 60051-1.....	Közvetlen működésű, analóg értékmutatású, mutatós villamos mérőműszerek és tartozékaik. 1. rész: Fogalom meghatározások és minden részre vonatkozó általános követelmények
EN 60061-2.....	Lámpafejek és lámpafoglatok, valamint a csereszabotosságukat és biztonságukat ellenőrző idomszerek. 2. rész: Lámpafoglatok
EN 60081	Két végükön fejtelt fénycsövek. Működési követelmények
EN 60155	Fénycsőgyűjtők
EN 60238	Edison-menetes lámpafoglatok
EN 60269	Kisfeszültségű biztosítók
EN 60309	Csatlakozódugók, csatlakozóaljzatok és csatlakozóeszközök ipari célokra
EN 60335-1.....	Háztartás és hasonló jellegű villamos készülékek biztonsága
EN 60400	Fénycsőfoglatok és gyűjtőfoglatok
EN 60417-1.....	Berendezéseken használt grafikai jelképek. 1. rész: Áttekintés és alkalmazás
EN 60423	Védőcsőrendszerek vezeték szerelésekhez. Villamos létesítések védőcsöveinek külső átmérői, valamint a védőcsövek és tartozékaik menetei
EN 60439	Kisfeszültségű kapcsoló- és vezérlőberendezések
EN 60445	Az ember-gép kapcsolat, a megjelölés és az azonosítás alapvető és biztonsági elvei. A villamos gyártmányok csatlakozó vezetékvei és a vezetékek azonosítása
EN 60454	Öntapadó szigetelőszalagok villamos ipari célokra
EN 60514	2-es osztályú váltakozó áramú fogyasztásmérők átvételi vizsgálata
EN 60529	Villamos gyártmányok burkolatai által nyújtott védettségi fokozatok (IP-kódok)
EN 60598	Lámpatestek
EN 60669	Kapcsolók háztartási és hasonló jellegű, rögzített villamos szerelésekhez
EN 60670	Dobozok és burkolatok háztartási és hasonló jellegű, rögzített villamos szerelések villamos szerelési anyagaihoz
EN 60684-1 ...-3.....	Hajlékony szigetelőcsövek
EN 60715	Kisfeszültségű kapcsoló- és vezérlőkészülékek méretei. Szabványos szerelősínek kapcsoló- és vezérlőberendezések villamos készülékeinek mechanikai rögzítéséhez
EN 60730	Automatikus villamos szabályozó- és vezérlőkészülékek háztartási és hasonló jellegű alkalmazásra
EN 60831-1.....	Öngyógyuló típusú, nagyteljesítményű söntkondenzátorok legfeljebb 1 kV névleges feszültségű váltakozó áramú rendszerek számára. 1. rész: Általános rész. Kialakítás, vizsgálatok és névleges értékek. Biztonsági követelmények. Szerelési és üzemeltetési irányelvek
EN 60838-1.....	Különböző lámpafoglatok. 1. rész: Általános követelmények és vizsgálatok
EN 60838-2-2.....	Különböző lámpafoglatok. 2-2. rész: Egyedi követelmények. LED-modulok csatlakozói
EN 60898-1,-2.....	Villamos szerelési anyagok. Túláramvédelmi megszakítók háztartási és hasonló jellegű berendezésekhez
EN 60900	Feszültség alatti munkavégzés. Kéziszerszámok legfeljebb 1000 V váltakozó feszültségen és 1500 V egyenfeszültségen való használatra
EN 60904-2.....	Fotovillamos eszközök. 2. rész: Referencia-napelemek követelményei
EN 60920	Fénycsőelőtétetek. Általános és biztonsági követelmények
EN 60921	Fénycsőelőtétetek. Működési követelmények

- EN 60926 Lámpatartozékok. Gyűjtőkészülékek (a parázsfénygyűjtők kivételével). Általános és biztonsági követelmények
- EN 60927 Lámpatartozékok. Gyűjtőkészülékek (a parázsfénygyűjtők kivételével). Működési követelmények
- EN 60928 Lámpatartozékok. Váltakozó árammal táplált elektronikus fénycsőelőtétetek. Általános és biztonsági követelmények
- EN 60929 Váltakozó és/vagy egyenfeszültségről táplált elektronikus fénycsőelőtétetek. Működési követelmények
- EN 60947 Kisfeszültségű kapcsoló- és vezérlőkészülékek
- EN 60947-3..... Kisfeszültségű kapcsoló- és vezérlőkészülékek. 3. rész: Kapcsolók, szakaszolók, szakaszolókapcsolók és biztosítókapcsolókészülék kombinációk
- EN 60947-7 Kisfeszültségű kapcsoló- és vezérlőkészülékek. 7. rész: Tartozékok
- EN 60968 Beépített előtétetes lámpák általános világítási célra. Biztonsági követelmények
- EN 60969 Beépített előtétetes lámpák általános világítási célra. Működési követelmények
- EN 60998 Csatlakozóelemek kisfeszültségű áramkörökhöz, háztartási és hasonló célokra
- EN 60999 Csatlakozóelemek. Villamos rézvezetők. Csavar típusú és csavar nélküli szorítóegységek biztonsági követelményei
- EN 61009-1, -2..... Áram-védőkapcsolók, beépített túláramvédelemmel, háztartási és hasonló használatra (RCBO-védőkapcsolók).
- EN 61010-1 Villamos mérő-, szabályozó- és laboratóriumi készülékek biztonsági előírásai. 1. rész: Általános előírások (IEC 61010-1:2010)
- EN 61048 Lámpatartozékok. Kondenzátorok fénycsövekhez és egyéb kisülőlámpákhoz. Általános és biztonsági követelmények
- EN 61049 Kondenzátorok fénycsövek és egyéb kisülőlámpák áramköreihez. Működési követelmények
- EN 61058-1 Készülékkapcsolók. 1. rész: Általános követelmények
- EN 61195 Két végükön fejtett fénycsövek. Biztonsági előírások
- EN 61210 Csatlakozóelemek. Lapos, gyorscsatlakozású kapcsok villamos rézvezetőkhez. Biztonsági követelmények
- EN 61215 Földfelszíni alkalmazású, kristályos szilícium fotovillamos (PV) modulok A szerkezeti felépítés minősítése és típusjváhagyás
- EN 61238-1 Sajtolt és mechanikus kötőelemek 36 kV-ig ($U_m = 42$ kV) terjedő névleges feszültségű erőáramú kábelekhöz. 1. rész: Vizsgálati módszerek és követelmények
- EN 61242 Villamos szerelési anyagok. Vezetékdobos hosszabbítók háztartási és hasonló célokra
- EN 61326-2-2 Méréstechnikai, irányítástechnikai és laboratóriumi villamos berendezések. EMC-követelmények
- EN 61347-2..... Lámpaműködtető eszközök. 2. rész
- EN 61386 Védőcsőrendszerek villamos szerelésekhez. 1. rész: Általános követelmények
- EN 61439 Kisfeszültségű kapcsoló- és vezérlőberendezések
- EN 61439-1 Kisfeszültségű kapcsoló- és vezérlőberendezések. 1. rész: Általános szabályok
- EN 61543 Háztartási és hasonló jellegű, érintésvédelmi célú áram-védőkészülékek. Elektromágneses összeférhetőség
- EN 61549 Különböző lámpák
- EN 61558 Teljesítménytranszformátorok, tápegységek, indukciós tekercsek és hasonló termékek biztonsága
- EN 61643-1...-341.. Kisfeszültségű túlfeszültség-levezető eszközök
- EN 61643-11 Kisfeszültségű túlfeszültség-levezető eszközök. 11. rész: Kisfeszültségű hálózatra csatlakozó túlfeszültség-levezető eszközök. Követelmények és vizsgálatok
- EN 61646 Földi fotovillamos (PV) vékonyréteg-modulok. A szerkezeti felépítés minősítése és típusjváhagyás
- EN 61730-1,-2 Fotovillamos (PV-) modulok biztonságtechnikai minősítése
- EN 61810 Elektromechanikus elemi relék
- EN 61869 Mérőtranszformátorok
- EN 61984 Csatlakozók. Biztonsági követelmények és vizsgálatok
- EN 62031 Általános világításhoz használt LED-modulok. Biztonsági előírások
- EN 62052-11..... Váltakozó áramú villamos fogyasztásmérő berendezések. Általános követelmények, vizsgálatok és vizsgálati feltételek. 11. rész: Fogyasztásmérő berendezések
- EN 62053 Váltakozó áramú villamos fogyasztásmérő berendezések. Egyedi követelmények. 11. rész: Elektromechanikus fogyasztásmérők hatásos energia mérésére (0,5-ös, 1-es és 2-es pontossági osztály)
- EN 62208 Üres burkolatok kisfeszültségű kapcsoló- és vezérlőberendezésekhez. Általános követelmények

EN 62275	Kábelszerelvény-rendszerek. Kábelkötegelő bilincsek villamos berendezésekhez
EN 62384	LED-modulok egyenárammal vagy váltakozó árammal táplált elektronikus előtétjei. Működési követelmények
EN 62423	F típusú és B típusú áram-védőkapcsolók beépített túláramvédelemmel és a nélkül, háztartási és hasonló célokra
EN 62560	50 V-nál nagyobb feszültségű, beépített előtétes LED-lámpák általános világítási célra. Biztonsági előírások
EN 62612	50 V-nál nagyobb tápfeszültségű, beépített előtétes LED-lámpák általános világítási célra. Működési követelmények
EN ISO 11148-10.....	Nem villamos hajtású motoros kéziszerszámok. Biztonsági követelmények. 10. rész: Motoros sajtólószerszámok
EN ISO 3506-1.....	Korrózióálló acél kötőelemek mechanikai tulajdonságai. 1. rész: Csavarok
EN ISO 4017	Hatlapfejű, tövig menetes csavarok. A és B pontossági fokozat
EN ISO 4032	Hatlapú, szabályos csavaranyák (1. típus). A és B pontossági fokozat
EN ISO 898-1.....	Ötvözött és ötvözetlen acélból készült kötőelemek mechanikai tulajdonságai. 1. rész: Meghatározott szilárdsági csoport-jelű csavarok. Normál és finom métermenetű csavarok
HD 60364-7-712.....	Épületek villamos berendezéseinek létesítése. 7-712. rész: Különleges berendezésekre vagy helyiségekre vonatkozó követelmények. Napelemes (PV) energiaellátó rendszerek
HD 60364-7-714.....	Kisfeszültségű villamos berendezések. 7-714. rész: Különleges berendezésekre vagy helyekre vonatkozó követelmények. Szabdtéri világítóberendezések
HD 629.1 S2.....	A 3,6/6 (7,2) kV-tól 20,8/36 (42) kV-ig terjedő névleges feszültségű erősáramú kábelek szerelvényeinek vizsgálati követelményei. 1. rész: Extrudált szigetelésű kábelek
HD 639 S1	Villamos szerelési anyagok. Hordozható áram-védőkapcsolós készülékek, beépített túláramvédelem nélkül, háztartási és hasonló célokra (PRCD-készülékek)
IEC 51.....	Közvetlen működésű, analóg értékmutatású, mutató villamos mérőműszerek és tartozékaik
IEC 60884.....	Csatlakozódugók és csatlakozóaljzatok háztartási és hasonló célokra.
IEC 60884-1	Csatlakozódugók és csatlakozóaljzatok háztartási és hasonló célokra. 1. rész: Általános követelmények
IEC 61643-1	A kisfeszültségű elosztóhálózatok túlfeszültségvédelmi eszközei. 1. rész: Működési követelmények és vizsgálati módszerek
ISO 2380	Csavarhúzó egyenes hornyú csavarokhoz
ISO 5743	Fogók és csípőfogók általános műszaki követelményei
ISO 5746	Egyetemes fogók fő méretei és vizsgálati adatai
ISO 5748	Homlokcsípőfogók fő méretei és vizsgálati adatai
ISO 5749	Oldalcsípőfogók fő méretei és vizsgálati adatai
ISO 8764	Csavarhúzó- végződéses kereszthornyos csavarokhoz
MSZ 263-4	Nagyfeszültségű szigetelők. 1 kV-nál nem nagyobb feszültségű szigetelők. Műszaki követelmények és vizsgálati előírások
MSZ 275-1...-3	Erősáramú szabadvezetékek szerelvényei
MSZ 9871-2	Háztartási és hasonló célú csatlakozódugók és csatlakozóaljzatok méretelőírásai és kiegészítő vizsgálóeszközei. 2. rész: Két-pólusú, váltakozó áramú csatlakozódugók és csatlakozóaljzatok oldalsó védő-érintkezővel, 250 V, 16 A
MSZ 9872.....	Átalakító csatlakozó 250 V/2,5 A-es, II. érintésvédelmi osztályú, lapos csatlakozódugók csatlakoztatására
MSZ IEC 61643-1	A kisfeszültségű elosztóhálózatok túlfeszültségvédelmi eszközei. 1. rész: Működési követelmények és vizsgálati módszerek
MSZ-05-45.1601.....	Erősáramú vezetékek villamos kötőelemei 1000 V-ig való alkalmazásra

**A Tracon Budapest Kft. a folyamatos termékfejlesztés érdekében a változtatás jogát fenttartja,
és az esetleges nyomdai hibákért felelősséget nem vállal!**

1-9

5458.....	C/11
8138.....	C/11
9006.....	B/6
9039.....	B/5
9843.....	C/11
1000PR	C/2
100N-GY.....	C/5
110-CS.....	C/8
120J.....	C/7
120K	C/3
120N-GY.....	C/5
120PR	C/2
130PR	C/2
132-12.....	C/4
150-CS.....	C/8
150L.....	C/6
150N-GY.....	C/5
150P.....	C/3
150PR	C/2
150Z.....	C/3
160-CS.....	C/8
160N-GY.....	C/5
160PR	C/2
170K	C/3
170P.....	C/3
170PR	C/2
170Z.....	C/3
180-12.....	C/4
180N-GY.....	C/5
180-NY.....	C/5
180PR	C/2
190J.....	C/7
190K	C/3
190PR	C/2
190Z.....	C/3
200-CS.....	C/8
200J.....	C/7
200K	C/3
200L.....	C/6
200N-GY.....	C/5
200PR	C/2
210PR	C/2
220PR	C/2
230NZ	C/3
230PR	C/2
250PR	C/2
260-NY.....	C/5
260PR	C/2
260T.....	C/6
265-12	C/4
270PR	C/2
280-NY.....	C/5
280PR	C/2
3 VF100-BTSH.....	F/49
30/15SIN	H/21
300-12	C/4
300-CS.....	C/8
300L.....	C/6
300PR	C/2
310-CS.....	C/8
35/7,5 SIN	F/13
35/7,5SIN-1000...M/13	
35/7,5SIN-137.....M/13	
35/7,5SIN-20.....M/13	
35/7,5SIN-500.....M/13	
35/7,5SIN-60.....M/13	
35/7,5SIN-T-1000..M/13	
35/7,5SIN-T-200...M/13	
350-NY.....	C/5
360-12	C/4
370-CS.....	C/8
370PR	C/2
380L.....	C/6
400-CS.....	C/8

430PR	C/2
450PR	C/2
530PR	C/2
5458N	C/11
550PR	C/2
580PR	C/2
610PR	C/2
760PR	C/2
80PR	C/2
850PR	C/2
9004-LT.....	B/5
9006R	B/6
9006RS	B/6
9039A	B/5
9039AR	B/5
9039A-SPEC.....	B/5
9039B	B/5
9039BR	B/5
9039B-SPEC.....	B/5
9039-HEXA.....	B/5
9102-LT.....	B/5

A

A880L.....	L/30
ACAM48-.....	L/3
ACAM48-.....	L/4
ACAM72-.....	L/3
ACAM72-.....	L/4
ACAM96-.....	L/3
ACAM96-.....	L/4
ACAMD-.....	L/12
ACAMSD-10	L/10
ACVM48-.....	L/2
ACVM72-.....	L/2
ACVM96-.....	L/2
ACVMD-.....	L/13

ACVMS-.....	L/9
AHC.....	A/42-45
AKKU1	B/9
AKKUT1	B/9
AKM1-.....	I/2
AKM1AL.....	I/3
AKM1AX1	I/3
AKM1AX2	I/3
AKM1AXAL	I/3
AKM1HD	I/4
AKM1MD230	I/5
AKM1MD400	I/5
AKM1SHT230	I/3
AKM1SHT24DC.....	I/3
AKM1SHT400	I/3
AKM1TM.....	I/5
AKM1UVR	I/3
AKM2-.....	I/2
AKM2AL.....	I/3
AKM2AX1	I/3
AKM2AX2	I/3
AKM2AXAL	I/3
AKM2HD	I/4
AKM2MD230	I/5
AKM2MD400	I/5
AKM2SHT230	I/3
AKM2SHT24DC.....	I/3
AKM2SHT400	I/3
AKM2TM.....	I/5
AKM2UVR	I/3
AKM3-400	I/2
AKM34AL.....	I/3
AKM34AX1	I/3
AKM34AX2	I/3
AKM34AXAL	I/3
AKM34HD.....	I/4
AKM34MD230	I/5
AKM34MD400	I/5

AKM34SHT230	I/3
AKM34SHT24DC.....	I/3
AKM34SHT400	I/3
AKM34UVR	I/3
AKM3TM.....	I/5
AKM4-630	I/2
AKM4TM.....	I/5
AKR1-.....	H/21
AM-60/250/3.....	I/22
AM-60/250/3/120-10	I/22
AM-60/250/3/120-5..	I/22
AM-60/630/3.....	I/22
AMAX3	C/20
AMAX5	C/20
AMAX6	C/20
AS120-.....	A/7
AS150-.....	A/7
AS16-.....	A/7
AS16-70CS12.....	A/12
AS185-.....	A/7
AS185-240CS16...A/12	
AS240-.....	A/7
AS25-.....	A/7
AS35-.....	A/7
AS50-.....	A/7
AS70-.....	A/7
AS95-.....	A/7
A-SST-60/3.....	I/22
A-SST-60/4.....	I/22
AT.....	A/11
AT16-70CS	A/11
AT185-240CS	A/11
AT95-150CS	A/11
AV1001200SH	L/27
AV1001600SH	L/27
AV1002000SH	L/27
AV1002500SH	L/27
AV1003000SH	L/27

AV30100SH	L/26
AV30150SH	L/26
AV30200SH	L/26
AV3060SH	L/26
AV3075SH	L/26
AV40100SH	L/27
AV40150SH	L/27
AV40200SH	L/27
AV40250SH	L/27
AV40300SH	L/27
AV40400SH	L/27
AV40500SH	L/27
AV601000SH	L/27
AV601200SH	L/27
AV60600SH	L/27
AV60800SH	L/27
AVBS-.....	L/26

B

B10	M/2
B10-15.....	M/2
B20	M/2
BCSV-.....	C/13
BD02	B/21
BD05	B/21
BD06	B/21
BD069	B/21
BD07	B/21
BDT06	B/21
BELL230.....	F/48
BELL24.....	F/48
BELL8.....	F/48
BELL8S.....	F/48
BELLW1-.....	F/47
BK-130.....	C/6
BSZ1-.....	C/20

BSZ2-.....C/20	CF72-0,5/1.....L/7	CLH70-.....A/5	D31E.....B/9	DCVMS-.....L/9	E08N-18.....A/22
BT-8/1.....F/43	CF72-0,5/3.....L/7	CLH95-.....A/5	D51-.....B/8	DCVMS-X/75.....L/9	E09.....A/23
BT-8/2.....F/43	CF96-0,5/1.....L/7	C0201A.....F/50	D51-.....B/9	DK60E.....B/10	E090.....A/23
BV0603.....M/9	CF96-0,5/3.....L/7	CS.....A/9	D52F-.....B/8	DKV105.....B/11	E09N.....A/22
BV0705.....M/9	CFD-72.....L/14	CS.....A/19	D55E.....B/9	DN200X200.....M/19	E09N-12.....A/22
BV1006.....M/9	CFD-96.....L/14	CSA-.....A/19	D60.....M/20	DN250X250.....M/19	E09N-18.....A/22
BV1108.....M/9	CL1.5-.....A/4	CSE.....A/19	D60S.....M/20	DPN.....F/12	E100.....A/23
BV1410.....M/9	CL10-.....A/4	CSEL.....A/19	D60SM.....M/20	DPN-C-.....F/30	E10N.....A/22
BV2015.....M/9	CL120-.....A/4	CSH.....A/18	D60T.....M/21	DTT.....L/15	E10N-18.....A/22
BV2518.....M/9	CL150-.....A/4	CSKARA10.....C/21	D62-.....B/9	DTT-1-.....L/13	E110.....A/23
BV3225.....M/9	CL16-.....A/4	CSKARA12.....C/21	D62E.....B/9	DVK3X0.75.....G/8	E113.....A/23
BVZ0603.....M/9	CL185-.....A/4	CSKARA3,5.....C/21	D70.....M/20	DVK3X1.0.....G/8	E114.....A/23
BVZ0706.....M/9	CL2.5-.....A/4	CSKARA4.....C/21	D70/8.....M/20	DVK3X2,5-1,5.....G/8	E115.....A/23
BVZ1006.....M/9	CL240-.....A/4	CSKARA5.....C/21	D70D.....M/20	DVK3X2,5-3.....G/8	E116.....A/23
BVZ1108.....M/9	CL25-.....A/4	CSKARA6.....C/21	D70SET.....M/20	DVKE2X0.75.....G/8	E117.....A/23
BVZ1410.....M/9	CL300-.....A/4	CSKARA7.....C/21	D70SZ.....M/20	DVKE2X1.0.....G/8	E118.....A/23
BVZ2015.....M/9	CL35-.....A/4	CSKARA8.....C/21	D70SZT.....M/20		E119.....A/23
BVZ2518.....M/9	CL4-.....A/4	CSKARA9.....C/21	D70T.....M/21		E11N.....A/22
BVZ3225.....M/9	CL400-.....A/4	CSKT.....C/8	D70TRI.....M/20	E	E120.....A/23
BY50.....M/3	CL50-.....A/4	CSS-.....C/12	D80.....M/20	E010.....A/23	E121.....A/23
	CL500-.....A/4	CST1.....M/10	D80T.....M/21	E01N.....A/22	E122.....A/23
C	CL6-.....A/4	CST15B.....M/10	D80X80.....M/20	E020.....A/23	E123.....A/23
C120F-.....B/8	CL625-.....A/4	CST15W.....M/10	DC.....F/12	E030.....A/23	E124.....A/23
C60-.....F/43	CL70-.....A/4	CST25.....M/10	DC-1C-.....F/33	E02N.....A/22	E125.....A/23
C60-CSEN-.....F/42	CL95-.....A/4	CST25F.....M/10	DC-2C-.....F/33	E030.....A/23	E126.....A/23
C60-S2.....F/29	CLH1.5-.....A/5	CST4.....M/10	DC-3C-.....F/33	E034.....A/23	E127.....A/23
C60-U2/02.....F/29	CLH10-.....A/5	CST4-.....M/10	DC-4C-.....F/33	E03N.....A/22	E128.....A/23
CC100.....B/14	CLH10-.....A/5	CSTALP.....C/10	DCAM48-.....L/3	E040.....A/23	E129.....A/23
CC22.....B/14	CLH120-.....A/5	CSTALP-.....C/10	DCAM48-0,02.....L/3	E04N.....A/22	E12N.....A/22
CC250.....B/14	CLH150-.....A/5	CSTBOX.....M/10	DCAM72-.....L/3	E05.....A/23	E12N-18.....A/22
CC38.....B/14	CLH16-.....A/5		DCAM72-0,02.....L/3	E050.....A/23	E13.....A/23
CC500.....B/14	CLH185-.....A/5	D	DCAM96-.....L/3	E05N.....A/22	E130.....A/23
CC60.....B/14	CLH2.5-.....A/5	D100X100.....M/20	DCAM96-0,02.....L/3	E060.....A/23	E131.....A/23
CC60.....B/14	CLH240-.....A/5	D150X150.....M/20	DCAM96-0,02.....L/3	E06N.....A/22	E132.....A/23
CC80.....B/14	CLH25-.....A/5	D31-.....B/8	DCAMS-20M.....L/9	E070.....A/23	E133.....A/23
CF45S-0,5/1.....L/10	CLH35-.....A/5	D31-.....B/9	DCVM-.....L/5	E07N.....A/22	E134.....A/23
CF45S-0,5/3.....L/10	CLH4-.....A/5		DCVM48-.....L/2	E080.....A/23	E135.....A/23
	CLH50-.....A/5		DCVM72-.....L/2	E08N.....A/22	E136.....A/23
	CLH6-.....A/5		DCVM96-.....L/2		

E137.....A/23	EDFK-18/1ANH/6	EVOG2PF/22	EVOTDAF/12	F48-220/50L/7	FHH660C/22
E13I.....A/24	EDFK-2/1ANH/6	EVOG4PF/22	EVOTDA-AL.....F/15	F50L.....B/2	FHH8110C/22
E13IR.....A/24	EDFK-2/1ANPH/7	EVOHF/12	EVOTDA-AUX11F/15	F520.....C/7	FK.....L/33
E13NA/22	EDFK-4/1ANH/6	EVOH1F/18	EVOTDA-SRF/15	F521.....C/7	FLE-A/29
E14.....A/23	EDFK-4/1ANPH/7	EVOH2F/18	EVOTDA-UOVRF/15	F6L.....B/2	FLEAL-.....A/30-31
E140.....A/23	EDFK-8/1ANH/6	EVOH3F/18	EVOUC2P63F/28	F840.....C/7	FLS35/10X4.....A/29
E142.....A/23	EDFK-8/1ANPH/7	EVOH4F/18	EVOU02F/28	F841.....C/7	FLS35/4X9.....A/29
E144.....A/23	EDFKF-H/9	EVOH-AL.....F/15	EVOU02J/15	F96-220/50L/7	FLS50/16X4.....A/29
E146.....A/23	EDFKIP65-H/6	EVOH-AUX11F/15	EVOU04F/28	FD-72.....L/14	FLS70/10X8.....A/29
E14NA/22	EDFKN-.....H/2	EVOHK2-.....F/27	EVOU04J/15	FD-96.....L/14	FLS0A/32-33
E14N-25.....A/22	EDFKS-.....H/3	EVOHK4-.....F/27	EVOU04P63F/28	FE100.....H/19	FLSOT35.....A/34
E15N-30.....A/22	EDFKSN-.....H/3	EVOH-SRF/15	EVOVF/13	FE15.....H/19	FLSOT95.....A/34
E16.....A/23	EDS-H/2	EVOH-UOVRF/15	EVOV2PF/21	FE150.....H/19	FLSOT95L.....A/34
E16I.....A/24	EDS, EDFKF/13	EVOKF/13	EVOV4PF/21	FE30.....H/19	FSH10120C/22
E16IR.....A/24	EDSF-H/9	EVOK2BF/20	EVOZF/12	FE45.....H/19	FSH12130C/22
E16N-32.....A/22	EDSN-H/2	EVOK2CF/20	EVOZ1BF/16	FE60.....H/19	FSH16140C/22
E19.....A/23	EDSS-H/4	EVOKEF/13	EVOZ1CF/16	FE75.....H/19	FSH550C/22
E19I.....A/24	EDSSN-H/4	EVOKEBF/19	EVOZ2BF/16	FEH10.....M/2	FSH570C/22
E20I.....A/24	EDTMH/7	EVOKECF/19	EVOZ2CF/16	FEH10-15M/2	FSH6100C/22
E22.....A/23	EKBV-H/13	EVOKMF/13	EVOZ3BF/16	FEH20.....M/2	FSH660C/22
E22I.....A/24	EL.....A/40-41	EVOKM2BF/20	EVOZ3CF/16	FEH50.....M/2	FSH8110C/22
E24.....A/23	EM264.....L/30	EVOKM2CF/20	EVOZ4BF/16	FEK10.....M/2	FSH870C/22
E24I.....A/24	EM306B.....L/31	EVOKONDG/2	EVOZ4CF/16	FEK10-15M/2	FSS10120.....C/22
E26.....A/23	EM422A.....L/32	EVOMSF/25	EVOZ-ALF/15	FEK20.....M/2	FSS12130.....C/22
E26I.....A/24	EPSA-L/28-29	EVOMS100/3I/35	EVOZ-AUX11F/15	FEK50.....M/2	FSS550.....C/22
E28.....A/23	ESPD1+2-F/4	EVOMS125/3I/35	EVOZ-SR.....F/15	FEV250H/19	FSS570.....C/22
E29.....A/23	ESPD1+2+3-.....F/6	EVOMS16/3I/35	EVOZ-UOVRF/15	FEV400.....H/19	FSS6100.....C/22
E30.....A/23	ESPD1+2-DC.....F/7	EVOMS20/3I/35		FFE150-185A/28	FSS660.....C/22
E32.....A/23	ESPD2-F/5	EVOMS25/3I/35		FFE35-50A/28	FSS8110.....C/22
E50I.....A/24	ESPD2-F/7	EVOMS40/3I/35	F	FFE50-70A/28	FSS870.....C/22
E50IH.....A/24	ESPD2+3-F/6	EVOMS80/3I/35	F125.....C/7	FFE70-95A/28	FSZIG.....A/13
E90I.....A/24	ESPD3-10-F/7	EVONF/12	F200.....C/7	FFE95-240A/28	FV-01L/33
E90IH.....A/24	ESPD3-3-2PF/7	EVONCF/18	F201.....C/7	FHH10120C/22	FV-06L/33
ED-H/5	ESPD3-5-F/7	EVOPBF/26	F25L.....B/2	FHH12130C/22	FV24.....L/33
EDFK-H/2	EVOBT15/1F/26	EVOPB2F/26	F290.....C/7	FHH16140C/22	
EDFK-1/1ANH/6	EVOBT24/1F/26	EVOPBLF/26	F291.....C/7	FHH550C/22	
EDFK-1/1ANPH/7	EVOBT30/1F/26	EVOPSF/26	F45S-230/50.....L/10	FHH570C/22	
EDFK-12/1ANH/6	EVOGF/13	EVOPSLF/26		FHH6100C/22	

G	HD156.....B/6	HR5-45.....C/19	J	JPL1.....C/24	KH.....B/6
	HD156R.....B/6	HR5-50.....C/19		JPL2.....C/24	KH4.....A/16
GBT.....C/15	HGS-01.....H/20	HR6-80.....C/19	J02-.....M/11	JPL3.....C/24	KHA4.....A/16
GCS-.....M/9	HK3.....G/10	HR8-100.....C/19	J02+.....M/11	JSET.....M/11	KL.....A/25
GD-.....M/19	HK3-3M.....G/10	HRRK2/2.....G/12	J020...J029.....M/11	JSET/B.....M/11	KL-1000.....B/14
GLK1-.....H/20	HK3-5M.....G/10	HRRK3/3.....G/12	J02GND.....M/11		KM1.....I/6
GLK2-.....H/20	HK36A.....L/31	HRRK6.....G/12	J02X.....M/11	K	KM1-.....I/7
GSZT.....C/15	HK3-USB.....G/12	HRRKF3/3.....G/12	J02Y.....M/11		KM1-HM.....I/8
GTL30.....C/14	HK4.....G/10	HRRKT6.....G/12	J10.....A/40-41	K10.....M/2	KM2.....I/6
GTL40.....C/14	HK4-3M.....G/10	HRRKTF3/3.....G/12	J15-.....M/11	K10-15.....M/2	KM2-.....I/7
GTL43.....C/14	HK4-5M.....G/10	HSZ.....A/20	J15/.....M/11	K20.....M/2	KM2G.....I/23
	HK5.....G/10	HUR-.....G/10	J15+.....M/11	K50.....M/2	KM2G/A30-40.....I/23
	HK5-3M.....G/10	HX120B.....B/7	J150...J159.....M/11	KACS1.....G/14	KM2G-F.....I/23
H	HK5-5M.....G/10	HX150B.....B/7	J15A...J15Z.....M/11	KACS2.....G/14	KM2G-F/A30-40...I/23
	HK6.....G/10	HX50B.....B/7	J15GND.....M/11	KB-1000.....B/14	KM2-HM.....I/8
H3.....G/10	HK6-3M.....G/10	HZS105-100.....D/17	J4.....A/40-41	KBD25ST.....K/42	KM3.....I/6
H3-3M.....G/10	HK6-5M.....G/10	HZS105-200.....D/17	J4-.....M/11	KBD25STT.....K/42	KM3-.....I/7
H3-5M.....G/10	HKD-.....G/9	HZS105-400.....D/17	J4+.....M/11	KBJ25LO.....K/42	KM4.....I/6
H4.....G/10	HKS-15.....B/12	HZS28-100.....D/17	J40...J49.....M/11	KBJ25LOT.....K/42	KM4-.....I/7
H4-3M.....G/10	HKS-15-.....B/12	HZS28-200.....D/17	J4A...J4Z.....M/11	KB-UNI.....B/19	KM4-HM.....I/8
H4-5M.....G/10	HKT5-3M.....G/11	HZS28-400.....D/17	J5.....A/40-41	KBY.....B/19	KM5.....I/6
H5.....G/10	HKTF5-3M.....G/11	HZS36-100.....D/17	J6.....A/40-41	KC-1000.....B/14	KM5-.....I/8
H5-3M.....G/10	HKTM5-3M.....G/11	HZS36-200.....D/17	J8.....A/40-41	KCS.....A/16	KM6.....I/6
H5-5M.....G/10	HKTM6-.....G/11	HZS36-400.....D/17	JC01.....M/11	KCS.....A/21	KM6-.....I/8
H6.....G/10	HKTM8-.....G/11	HZS54-100.....D/17	JC02.....M/11	KCSE.....A/20	KM7.....I/6
H6-3M.....G/10	HKTMF5-3M.....G/11	HZS54-200.....D/17	JC03.....M/11	KCSH.....A/21	KM7-.....I/8
H6-5M.....G/10	HKTMF6-.....G/11	HZS54-400.....D/17	JC04.....M/11	KD-.....G/6	KM7-.....I/8
HB-10X38-.....I/17	HKTMF8-.....G/11	HZS92-100.....D/17	JC05.....M/11	KD-DOB.....G/6	KM7-PM.....I/9
HB-14X51-.....I/17	HL.....A/40-41	HZS92-200.....D/17	JC06.....M/11	KDZ-.....G/7	KMH.....F/12
HB-22X58-.....I/17	HLF-02.....B/19	HZS92-400.....D/17	JC07.....M/11	KE3.....G/8	KMH-.....F/34
HB-8X32-.....I/17	HNKTM10-3M-KT.G/11		JC08.....M/11	KE4-3M.....G/8	KOHR10.....M/4
HBA-1P-.....I/16	HNKTM8-3M-KT...G/11	I	JC09.....M/11	KE4-5M.....G/8	KOHR24.....M/4
HBA-2P-.....I/16	HNKTMF8-3M-KT.G/11		JC10.....M/11	KET-.....D/14	KOR50.....M/4
HBA-3P-.....I/16	HR3-25.....C/19	IMP-.....F/42	JC11.....M/11	KETO-.....I/18-19	KRT.....C/13
HBM-10X38-.....I/17	HR3-30.....C/19	ISZ72-230.....L/8	JC12.....M/11	KF-1000.....B/14	KRT8.....C/13
HBM-14X51-.....I/17	HR4-30.....C/19	ISZ96-230.....L/8	JC13.....M/11	KF-1000-2.....B/14	KSET1000.....B/15
HBM-22X58-.....I/17	HR4-35.....C/19	ISZ96-24.....L/8	JC14.....M/11	KGY-.....D/15	KSPI-.....C/23
HBM-8X32-.....I/17	HR4-40.....C/19		JC15.....M/11		KSPI-.....C/23

KSZA/14	LAK5/16-185I/22	LSME9101K/8	MG-25TGM/7	NARIDONJ/11	NYAE102K/44
KSZ16-A/14	LAK5/16-70I/22	LTTM/23	MG-32M/6	NARIMFJ/13	NYBDK/42
KT01G/31	LDM100L/33	LY03BB/7	MG-32-AM/8	NARIMPF/42	NYBGK/43
KT02G/31	LDM40L/33	LY03BRB/7	MG-32FM/6	NARISTJ/12	NYBJK/42
KTCSHA/21	LF266L/32	LY35CB/6	MG-40M/6	NARSF/41	NYG3-K/26-32
KT-DOBG/7	LJL16-K/36	LY731B/4	MG-40-AM/8	NARSJ/14	NYG3-K/34-35
KTHA/17	LJL22-K/36		MG-40FM/6	NARVJ/17	NYG442P30K/39
KU00I/23	LS15-COVK/4		MG-50M/6	NARV1J/16	NYG442P30TK/39
KU00/1/2X/A30-40 ..I/23	LS15G-BK/4	M	MG-50-AM/8	NPE-B6-M/14	NYG442P30TSK/39
KU00/2I/23	LS15GD-BK/4		MG-50FM/6	NPE-B8-M/14	NYG542P40K/39
KVA/15	LS15GM-BK/2	MACS16B/3	MG-63M/6	NPE-G6-M/14	NYG542P40TK/39
KVKF/13	LS15GQ21-BK/3	MACS6B/3	MG-63-AM/8	NPE-G8-M/14	NYG542P40TSK/39
KVK-F/35	LS15GQ-BK/4	MBF/12	MG-63FM/6	NPE-Z-H/5	NYG542P40TSK/39
KVKB-F/35	LS15GW21-BK/3	MB-1B-F/31	MGF-M/6	NPE-Z-M/14	NYG642P60K/39
KVKMF/13	LS15GW22-BK/3	MB-1C-F/31	MKM-I/11	NPE-Z-24H/17	NYG642P60TK/39
KVKM-F/36	LS15GW2-BK/3	MB-2B-F/31	MKM1I/10	NPE-Z-38H/17	NYG642P60TSK/39
KVKMB-F/36	LS15GW-BK/2	MB-2C-F/31	MKM1-I/10	NPE-ZBM/14	NYGBAK/37
KVKVEF/13	LS15HW24-BK/2	MB-3B-F/31	MKM2I/10	NPE-ZGM/14	NYGBAK/38
KVKVE-F/35	LS7100K/6	MB-3C-F/31	MKM2-I/10	NT0-I/12	NYGBCK/39
KVKVEB-F/35	LS7110K/6	MB-4C-F/31	MP1C/24	NT00-I/12	NYGBKK/43
KW3-K/24-25	LS7120K/5	MD-M/17	MP2C/24	NT00C-I/12	NYGBLK/37
KYT-D/15	LS7121K/6	MDLF/30	MSZ18M/4	NT1-I/12	NYGBPK/37
	LS7124K/6	MED-M/16	MSZ24M/4	NT2-I/12	NYGBRK/39
	LS7140K/5	MG-12M/6	MSZ36M/4	NT3-I/12	NYGBSK/39
L	LS7141K/5	MG-12-AM/8	MSZ48M/4	NTA-I/14	NYGBSK/39
	LS7144K/6	MG-12FM/6		NTA-00C-00I/14	NYGBVK/41
L10M/2	LS7166K/7	MG-12TGM/7		NTKI/15	NYGBWK/38
L20M/2	LS7310K/7	MG-16M/6	N	NTM0-I/12	NYGD-K/32
LAK10/1,5-16I/22	LS7311K/7	MG-16-AM/8	NOFC/12	NTM00-I/12	NYGD-1GRK/38
LAK10/1,5-35I/22	LS7312K/7	MG-16FM/6	N1C/12	NTM1-I/12	NYGD-FRK/34
LAK10/1,5-50I/22	LSME8104K/10	MG-16TGM/7	N10M/2	NTM2-I/12	NYGIK/44
LAK10/16-120I/22	LSME8107K/10	MG-20M/6	N2C/12	NTM3-I/12	NYGL-K/44
LAK10/16-185I/22	LSME8108K/11	MG-20-AM/8	N20M/2	NTR0I/15	NYGR25/22K/34
LAK10/16-70I/22	LSME8111K/9	MG-20FM/6	N3C/12	NTR00I/15	NYGR30/22K/34
LAK5/1,5-16I/22	LSME8112K/10	MG-20TGM/7	N4C/12	NTR1I/15	NYGR38/22K/34
LAK5/1,5-35I/22	LSME8122K/9	MG-25M/6	NARIDOFFJ/11	NTR2I/15	NYK3-K/28-31
LAK5/1,5-50I/22	LSME8166K/9	MG-25-AM/8	NARIDOFFSJ/12	NTR3I/15	NYKKK/40
LAK5/16-120I/22	LSME8169K/8	MG-25FM/6			

O	PCSHA/21	R	RKARA8C/21	S	SCALE-W72/4-P L/6
	PD100X100M/19		RKARA9C/21		SCALE-W96/4-P L/6
OFK16C/23	PD75X35M/19	RA120-A/8	RKV1000B/13	S00I/23	SCSA/16
OFK25C/23	PD75X75M/19	RA150-A/8	RKV300B/13	S1I/23	SCS6A/21
OFK38C/23	PD85X85M/19	RA16-A/8	RKV700B/13	S10M/2	SCSH6A/21
OFK9C/23	PF11-3AJ/8	RA16-70CS12A/12	RL08-J/6	S10-15M/2	SD101LDF/51
OKT15C/9	PG-M/5	RA185-A/8	RL11-J/6	S10A-HA/35	SD133AF/51
OKT20C/9	PG11-GM/5	RA185-240CS16A/12	RL14-J/6	S10A-H-LA/35	SD2575SLB/16
OKT25C/9	PG13,5-GM/5	RA240-A/8	RM08-J/2	S10A-UA/36	SD3060PH0B/16
OKT28C/9	PG16-GM/5	RA25-A/8	RM09-J/3	S15A-HA/35	SD3060PZ0B/16
OLC11A/26	PG21-GM/5	RA35-A/8	RM11-J/2	S15A-H-LA/35	SD375FB/15
OLC11DA/26	PG29-GM/5	RA50-A/8	RM12-J/3	S15A-UA/36	SD375SB/15
OLC21A/26	PG36-GM/5	RA70-A/8	RM14-J/3	S15GQ22-BK/3	SD40100SLB/16
ONVSZ19M/3	PG42-GM/5	RA95-A/8	RS90.22J/8	S2I/23	SD4100FB/15
ONVSZ25M/3	PG48-GM/5	RA95-150CS12A/12	RS90.23J/8	S20M/2	SD4100SB/15
ONVSZ38M/3	PG7-GM/5	RBF/13	RSPMF-14J/9	S3I/23	SD5080PH1B/16
OV02,5-A/27	PG9-GM/5	RB2-F/36	RSPSF-J/8	S30A-HA/35	SD5080PZ1B/16
OVO-AA/27	PGF-M/5	RB4-F/36	RSPTF-J/9	S30A-H-LA/35	SD5080SLPZ1B/17
OVOT2,5-A/27	PH4A/16	RCS11G/5	RSPYF-J/8	S30A-UA/36	SD5125FB/15
	PHA4A/16	RCS11-IPG/5	RT08-J/4	S3A-HA/35	SD5125SB/15
	PK30/34X10I/22	RCS13G/5	RT11-J/4	S3A-H-LA/35	SD55125SLB/16
	PK40/34X10I/22	RCS13-IPG/5	RT120/A/10	S3A-UA/36	SD60100PH2B/16
	PK50/34X10I/22	RE1A/40-41	RT150/A/10	S50M/2	SD60100PZ2B/16
P0070I/23	PK50/54X10I/22	RE2A/40-41	RT16/A/10	S5A-HA/35	SD60100SLPZ2B/17
P0095I/23	PK60/34X10I/22	RECA/42-45	RT185/A/10	S5A-H-LA/35	SD6100FB/15
P1I/23	PK60/54X10I/22	RG317B/4	RT240/A/10	S5A-UA/36	SD6100SB/15
P10M/2	PLA/25	RJ08-J/5	RT25/A/10	S60A-HA/35	SD6125FB/15
P10-15M/2	PR110-J/7	RJ11-J/5	RT35/A/10	S60A-H-LA/35	SD6125SB/15
P12I/23	PR12-J/7	RJ468B/4	RT50/A/10	S60A-UA/36	SD6150FB/15
P2I/23	PR24-J/7	RJ86B/4	RT70/A/10	SAD60/3I/22	SD6150SB/15
P20M/2	PR48-J/7	RKARA10C/21	RT95/A/10	SAD60/4I/22	SD65150SLB/16
P22I/23	PSZA/14	RKARA11C/21	RV02,5-A/26	SCALE-45 DC-XL/9	SD80150PH3B/16
P3I/23	PSZ10-A/14	RKARA12C/21	RVONA/27	SCALE-AC48-X/5AL/4	SD80150PZ3B/16
P32I/23	PSZ35-A/14	RKARA13C/21		SCALE-AC72-X/5AL/4	SDDK4100SB/15
P50M/2	PTCSHA/21	RKARA4C/21		SCALE-AC96-X/5AL/4	SDDK5125SB/15
PCSA/16	PTHA/17	RKARA5C/21		SCALE-DC48-X/75MVL/5	SDDK6150SB/15
PCSA/21	PVA/15	RKARA6C/21		SCALE-DC72-X/75MVL/5	SFA/40-41
PCSEA/20	PYF14AJ/9	RKARA7C/21		SCALE-DC96-X/75MVL/5	SF10A-HA/35

SF10A-H-L.....A/35	SLJL-DC24-.....F/25	SZ150-.....A/3	T10-PA.....C/17	TALP280.....C/11	TDA-3B-.....F/17
SF10A-U.....A/36	SOLAR11-.....A/28	SZ15A-U.....A/36	T10PCSPA.....C/17	TALP281.....C/11	TDA-3C-.....F/17
SF15A-H.....A/35	SOLAR11-PT.....B/3	SZ16-.....A/2	T10P-PA.....C/17	TB-.....M/23	TDA-4B-.....F/17
SF15A-H-L.....A/35	SOLAR1-2AB.....A/28	SZ16-.....A/2	T10-UNI.....C/15	TB525.....C/16	TDA-4C-.....F/17
SF15A-U.....A/36	SP10A-U.....A/36	SZ185-.....A/3	T12-PA.....C/17	TB535.....C/16	TDB01-.....G/27
SF30A-H.....A/35	SP15A-U.....A/36	SZ2.5-.....A/2	T12P-PA.....C/17	TB545.....C/16	TDB02-.....G/27
SF30A-H-L.....A/35	SPI10.....C/22	SZ20.....M/2	T140.....C/3	TB635.....C/16	TDB03-.....G/27
SF30A-U.....A/36	SPI12.....C/22	SZ240-.....A/3	T14-PA.....C/17	TB645.....C/16	TDB04-.....G/27
SF3A-H.....A/35	SPI15.....C/22	SZ25-.....A/2	T186.....C/3	TB655.....C/16	TDB05-.....G/28
SF3A-H-L.....A/35	SPI20.....C/22	SZ35-.....A/2	T200.....C/3	TB670.....C/16	TDB06-0M.....G/28
SF5A-H.....A/35	SPI25.....C/22	SZ4-.....A/2	T208.....C/3	TB8100.....C/16	TDB07-0M.....G/28
SF5A-H-L.....A/35	SPI6.....C/22	SZ50.....M/2	T281.....C/3	TB8120.....C/16	TDB08-0M.....G/28
SF60A-H.....A/35	SPI8.....C/22	SZ50-.....A/3	T293.....C/3	TB8135.....C/16	TDB09-.....G/29
SF60A-H-L.....A/35	SRTB25.....M/4	SZ70-.....A/3	T338.....C/3	TB845.....C/16	TDB10-.....G/29
SF60A-U.....A/36	SRTB50.....M/4	SZ95-.....A/3	T360.....C/3	TB860.....C/16	TDB11-0M.....G/29
SFC.....A/42-45	SRTYB25.....M/4	SZ-CL.....A/6	T5-UNI.....C/15	TB875.....C/16	TDB12-12MV.....G/29
SFD.....A/37	SRTYB50.....M/4	SZ-CLSN.....A/6	T6CS-PA.....C/17	TBSZ-.....B/18	TDB231377.....G/30
SH4.....A/16	SS10A-U.....A/36	SZEL.....A/40-41	T6H.....C/14	TBSZF-.....B/18	TDB302210.....G/30
SHA4.....A/16	SS15A-U.....A/36	SZICS.....A/20	T6K.....C/14	TBSZS-.....B/18	TDB333315.....G/30
SHK-.....F/40	SST-60/1.....I/22	SZICSH.....A/20	T6-PA.....C/17	TBT-.....A/25	TDB351377.....G/30
SHK2-.....F/40	SST-60/3.....I/22	SZIV-.....C/18	T6PCS-PA.....C/17	TCSA.....G/13	TDB351710.....G/30
SHK2-.....F/40	SST-60/4.....I/22	SZL1.....M/17	T6-UNI.....C/15	TCSAF.....G/13	TDB362613.....G/30
SHK3-.....F/40	SSTM-.....K/46-47	SZL3MD.....M/17	T8CS-PA.....C/17	TCSAH.....G/13	TDB461377.....G/30
SHK4-.....F/40	STCSH6.....A/21	SSZ25-.....A/14	T8-PA.....C/17	TCSAH-F.....G/13	TDB503315.....G/30
SHK4-.....F/40	STH.....A/17	SSZ3.....A/14	T8PCS-PA.....C/17	TCSAL.....G/13	TDB683315.....G/30
SK10A-U.....A/36	STS-.....H/21		T8P-PA.....C/17	TCSALH.....G/13	TDB-CABLE.....G/28
SK15A-U.....A/36	SV.....A/15		T8-UNI.....C/15	TCSD.....G/13	TDT.....H/7
SK30A-U.....A/36	SV50.....M/3	T	T92.....C/3	TCSDF.....G/13	TDT-2.....H/7
SK60A-U.....A/36	SVK1-.....F/24		TALP190.....C/11	TCSDH.....G/13	TDUG0.....G/15
SL.....A/25	SVK2-.....F/24	T10080P.....C/14	TALP190-2.....C/10	TCSDL.....G/13	TDUG09.....G/15
SL00-.....I/20	SVK3-.....F/24	T10100P.....C/14	TALP191.....C/11	TCSDLH.....G/13	TDUG09-BARN.....G/15
SL1-.....I/20	SVK4-.....F/24	T10120P.....C/14	TALP191-2.....C/10	TCSD0.....G/13	TDUG0-BARN.....G/15
SL2-.....I/20	SZ1.5-.....A/2	T10140P.....C/14	TALP200.....C/11	TCSDR.....G/14	TDUGOF.....G/15
SL3-.....I/20	SZ10.....M/2	T10160P.....C/14	TALP201.....C/11	TCSDRB.....G/14	TDZ.....F/12
SLJL-AC230-.....F/25	SZ10-.....A/2	T10200P.....C/14	TALP270.....C/11	TDA-1B-.....F/17	TDZ-1B-.....F/32
SLJL-AC230-.....F/25	SZ10-15.....M/2	T10240P.....C/14	TALP270-2.....C/10	TDA-1C-.....F/17	TDZ-1C-.....F/32
SLJL-AC24-.....F/25	SZ10A-U.....A/36	T10300P.....C/14	TALP271.....C/11	TDA-2B-.....F/17	TDZ-1D-.....F/32
SLJL-DC220-.....F/25	SZ120-.....A/3	T10CS-PA.....C/17	TALP271-2.....C/10	TDA-2C-.....F/17	TDZ-2B-.....F/32

TDZ-2C- F/32	TFE605025.....H/11	TFSS-1Z M/12	TGEMP150.....H/17	TKB- I/28	TME332513TH/8
TDZ-2D- F/32	TFE606025.....H/11	TFSS-2 M/12	TGEMP200.....H/17	TKCR-0708.....C/12	TME403017H/8
TDZ-3B- F/32	TFE606030.....H/11	TFSS-2V M/12	TGESL.....H/17	TKCRZ-C/13	TME403017MH/8
TDZ-3C- F/32	TFE705020.....H/11	TFSS-2Z M/12	TGF.....B/18	TKCSB/4	TME403017MTH/8
TDZ-3D- F/32	TFE705025.....H/11	TFSS-3 M/12	TGV2-I/50-53	TKF-I/30	TME403017R.....H/8
TDZ-4B- F/32	TFE806020.....H/11	TFSS-3-12.....M/12	THA/10	TKFK-I/30	TME403017TH/8
TDZ-4C- F/32	TFE806020M.....H/10	TFSS-3V M/12	TH10100C/16	TKFL-I/30	TME403020.....H/8
TDZ-4D- F/32	TFE806020T.....H/10	TFSS-3V-12.....M/12	TH10115C/16	TKH-C/23	TME403020TH/8
TDZ-F2 F/29	TFE806025.....H/11	TFSS-3Z M/12	TH10135C/16	TKI-FI/30	TME504018.....H/8
TEMS1- I/40	TFE806030.....H/11	TFSS-4 M/12	TH10160C/16	TKM-I/28-30	TME504018M.....H/8
TEMS2- I/40-41	TFG.....F/13	TFSS-4V M/12	TH1080C/16	TKO-G/2	TME504018MT.....H/8
TEMS3- I/40-41	TFG2-F/38	TFSS-4Z M/12	TH8100C/16	TKR-12T.....C/9	TME504018R.....H/8
TES- K/48-51	TFG4-F/38	TFSSCOV M/12	TH8120C/16	TKR130C/9	TME504018TH/8
TFE- H/12	TFGAF/13	TFV.....F/13	THC10100C/16	TKR200C/9	TME604020.....H/8
TFE1006025.....H/11	TFGA-F/38	TFV2-F/37	THC10115C/16	TKR-20T.....C/9	TME604020M.....H/8
TFE1008025.....H/11	TFIG.....F/13	TFV4-F/37	THC10135C/16	TKR300C/9	TME604020MT.....H/8
TFE1008030.....H/11	TFIG2-F/39	TFVH.....F/13	THC10160C/16	TKR310C/9	TME604020R.....H/8
TFE1008040.....H/11	TFIG4-F/39	TFVH4-F/37	THC1080C/16	TKT-I/35	TME604020TH/8
TFE1208030.....H/11	TFJA-L/21-25	TG007B/18	THC8100C/16	TKT-65I/25	TME605022.....H/8
TFE252015.....H/11	TFK101.....F/46	TG008B/18	THC8120C/16	TKT-65/2I/25	TME605022M.....H/8
TFE302515.....H/11	TFK101B.....F/46	TGE6010520H/14	THC8135C/16	TKT-65/3I/25	TME605022MT.....H/8
TFE303015.....H/11	TFK102.....F/46	TGE6012020H/14	THMS-H/20	TKT-65/4I/25	TME605022TH/8
TFE403015.....H/11	TFK105.....F/46	TGE6015020H/14	THSN.....A/17	TKTS-01I/25	TME705025.....H/8
TFE403020.....H/11	TFK106.....F/46	TGE6018020H/14	TICS-G/16-26	TKTS-02I/25	TME705025M.....H/8
TFE403020M.....H/10	TFKSCH-F/46	TGE606020H/14	TICSCAPG/19	TKTS-03I/25	TME705025MT.....H/8
TFE403020TH/10	TFKV-J/18-21	TGE607520H/14	TICS-RE230G/31	TKU-FI/30	TME705025R.....H/8
TFE404020.....H/11	TFM.....A/24	TGE609020H/14	TICS-RE400G/31	TKU-K.....I/30	TME705025TH/8
TFE404025.....H/11	TFSS.....F/13	TGEBFH/17	TIK1-F/23	TKU-VI/30	TMK.....C/18
TFE504015.....H/11	TFSS V.....F/13	TGEBM150H/17	TIK2-F/23	TKV-I/26-28	TMM.....C/18
TFE504020.....H/11	TFSS-1M/12	TGEBM200H/17	TIK3-F/23	TLA-3F/41	TMSZ.....C/18
TFE504020M.....H/10	TFSS-1+NM/12	TGECEH/17	TIK4-F/23	TMCSC/18	TMSZ-M/7
TFE504020TH/10	TFSS100-1M/12	TGEF6010520.....H/15	TK-I/26	TME282113.....H/8	TMZ-M/8
TFE504025.....H/11	TFSS-1-12.....M/12	TGEF6012020.....H/15	TK/T1+F1/I/25	TME282113M.....H/8	TN10C/16
TFE604020.....H/11	TFSS125-1M/12	TGEF6015020.....H/15	TK/T2+F1/I/25	TME282113MT.....H/8	TN12C/16
TFE605015.....H/11	TFSS-1CS.....F/13	TGEF6018020.....H/15	TK/T2+F2/I/25	TME282113T.....H/8	TN14C/16
TFE605020.....H/11	TFSS-1CSM/12	TGEF606020.....H/15	TK/T3+F3/I/25	TME332513.....H/8	TN2G/14
TFE605020M.....H/10	TFSS-1VM/12	TGEF607520.....H/15	TK/T3+F3S/I/25	TME332513M.....H/8	TN2/1G/16
TFE605020TH/10	TFSS-1V-12.....M/12	TGEF609020.....H/15	TKAI/25	TME332513MT.....H/8	TN3G/14

TN4G/14	TR2ADI/47	TTV1+2-F/8	U11C/19	V360-KNY.....H/18	VF100-F/49
TN6C/16	TR2HD13.....I/47	TTV2-40-.....F/8-9	U13C/19	V375.....H/18	VFG100.....F/49
TN8C/16	TR2HD33.....I/47	TTV2-60-F/9	U14C/19	V375-KNY.....H/18	VFM100-F/49
TNCS10C/16	TR2HF23I/47	TTV3-10-1P+N/PE...F/10	U16C/19	V4-A/9	VFS100.....F/49
TNCS12C/16	TR2HK03I/46	TTV3-10-3P+N/PE...F/10	U19C/19	V43.....H/18	VKP.....A/13
TNCS6C/16	TR5KNI/44	TTV3-5-1P+N-PE....F/11	U22C/19	V43-KNYH/18	VL.....A/40-41
TNCS8C/16	TR6DN.....I/44	TTV-CSF35F/11	U25C/19	V71.....H/18	VLC.....A/42-45
TND2.....G/15	TR7DR2.....I/45	TTVL2+3-10.....F/11	UD70M/21	V71-KNY.....H/18	VLDA/37
TND2-KG/15	TR7DT2I/45	TU140C/4	UDT60M/21	VAKFED60.....M/21	VM102.....K/20
TND2-USB.....G/15	TR8-I/45	TU186C/4	UH10G/7	VAKFED70.....M/21	VM106.....K/21
TND3.....G/15	TR9-I/45	TU200C/4	UH15G/7	VDG/31	VM110.....K/20
TNF2G/16	TRC252A/26	TU208C/4	UH20G/7	VE10045.....D/10	VM115.....K/21
TNF2/1G/16	TRC253A/26	TU281C/4	UH20RN.....G/7	VE12550.....D/10	VM121.....K/21
TNFSM/13	TRC254A/26	TU293C/4	UH25G/7	VE3259.....D/9	VM145.....K/22
TNFS10M/13	TRC255A/26	TU338C/4	UH30G/7	VE33816.....D/9	VM171.....K/22
TNFS16M/13	TRF0.....D/18	TU360C/4	USB-21.....F/46	VE3512.....D/10	VM181.....K/22
TNFS25M/13	TRF1.....D/18	TU92C/4	USBD.....G/9	VE3512C.....D/10	VP102.....K/14
TNFS2516M/13	TRF2.....D/18	TVO-1D216F.....L/20	USFA/40-41	VE3512-SZD/11	VP106.....K/14
TNFSBM/13	TRF3.....D/18	TVO-F1-L/19	USL1-I/20	VE38036.....D/9	VP110.....K/14
TNFSB1M/13	TRF4.....D/18	TVOF11.....L/18	UTILK.....B/20	VE4021D/10	VP118.....K/12
TNS2G/16	TRF5.....D/18	TVOF12.....L/18		VE4021C.....D/10	VP121.....K/12
TOP10C/17	TRF6.....D/18	TVOF14.....L/18		VE4021-SZD/11	VP127.....K/15
TOP6C/17	TRF7D/18	TVOF1M4.....L/18	V	VE510046.....D/11	VP145.....K/13
TOP8C/17	TRK4A/25	TVO-F3-L/20	V1.5-A/9	VE54019.....D/11	VP171.....K/15
TOPCS10.....C/17	TS-I/32-33	TVOF37.....L/18	V10-A/9	VE5527D/10	VP181.....K/15
TOPCS6C/17	TSF-L/8	TVOF3M7.....L/18	V150.....H/18	VE5527C.....D/10	VP191.....K/15
TOPCS8C/17	TSKAA/40-41	TVSZ25.....M/3	V150-KNY.....H/18	VE5527-SZD/11	VSL2-I/20
TP700A.....B/4	TSKCA/42-45	TVTR-K/52-53	V16-A/9	VE55524.....D/11	VSL3-I/20
TP700BB/4	TSKCJSA/42-45	TVTRB-K/54-55	V170.....H/18	VE58033.....D/11	VT102.....K/16
TQBY-M/15	TSKC-EJA/42-45		V170-KNY.....H/18	VE8035.....D/10	VT106.....K/18
TR-F/44	TSKDA/37	U	V2.5-A/9	VE8035C.....D/10	VT110.....K/16
TR1DI/36	TSM-I/35	U03C/19	V215.....H/18	VE8035-SZD/11	VT118.....K/17
TR1DI/38-39	TSS-I/34	U05C/19	V215-KNY.....H/18	VES10058.....D/16	VT121.....K/17
TR1E.....I/36	TSZK1-M/22	U06C/19	V23012.....D/9	VES124.....D/16	VT127K/18
TR1E.....I/42-43	TSZK2-M/22	U08C/19	V35.....H/18	VES208.....D/16	VT145.....K/17
TR1E.....I/49	TSZL4-M/23	U09C/19	V35-KNY.....H/18	VES3515.....D/16	VT171.....K/19
TR1KI/36	TSZL6-M/23		V360.....H/18	VES5524.....D/16	VT181.....K/18
TR1KI/37	TTK-F/45			VES7533.....D/16	VT191.....K/19

W

	ZS024SD/2	ZS095BD/2	ZS190LILD/2	ZS508ND/2	ZSTHKA/17
	ZS024SZ.....D/2	ZS095FEH.....D/2	ZS190ND/2	ZS508P.....D/2	ZSTHPA/17
W45S-230/1L/11	ZS024Z.....D/2	ZS095KD/2	ZS190P.....D/2	ZS508SD/2	ZSTHSA/17
W45S-400/4L/11	ZS024ZS.....D/2	ZS095LILD/2	ZS190SD/2	ZS508SZ.....D/2	ZSV120.....D/3
W72-400V/4L/6	ZS032.....D/2	ZS095ND/2	ZS190SZ.....D/2	ZS508Z.....D/2	ZSV180.....D/3
W96-400V/4L/6	ZS032BD/2	ZS095P.....D/2	ZS190Z.....D/2	ZS508ZS.....D/2	ZSV240.....D/3
WANKU00CSW201 ...G/5	ZS032FEH.....D/2	ZS095SD/2	ZS190ZS.....D/2	ZS63/19RD/4	ZSV30.....D/3
WANKU00SW6301 ...G/5	ZS032KD/2	ZS095SZ.....D/2	ZS20.....M/2	ZS75/22RD/4	ZSV390.....D/3
WCJB-A/8	ZS032LIL.....D/2	ZS095Z.....D/2	ZS254.....D/2	ZS760.....D/2	ZSV48.....D/3
WCJC-A/8	ZS032ND/2	ZS095ZS.....D/2	ZS254BD/2	ZS8/2RD/4	ZSV60.....D/3
	ZS032P.....D/2	ZS10.....M/2	ZS254FEH.....D/2	ZS95/30RD/4	ZSV90.....D/3
	ZS032SD/2	ZS10-15M/2	ZS254KD/2	ZSB130/36RD/4	ZSVR120D/3
	ZS032SZ.....D/2	ZS1020.....D/2	ZS254LILD/2	ZSB180/50RD/4	ZSVR190D/3

Y

	ZS032Z.....D/2	ZS1020P.....D/2	ZS254ND/2	ZSB33/8R.....D/4	ZSVR240D/3
YCSK-A/13	ZS032ZS.....D/2	ZS1020SD/2	ZS254P.....D/2	ZSB51/16RD/4	ZSVR30D/3
	ZS048.....D/2	ZS1020SZ.....D/2	ZS254SD/2	ZSB85/25R.....D/4	ZSVR390D/3
	ZS048BD/2	ZS1020Z.....D/2	ZS254SZ.....D/2	ZSBB-SETD/4	ZSVR48D/3
	ZS048FEH.....D/2	ZS115/34RD/4	ZS254Z.....D/2	ZSB-SETD/4	ZSVR60D/3

Z

Z10.....M/2	ZS048KD/2	ZS12/3RD/4	ZS254ZS.....D/2	ZSJR146/05D/16	ZSVR90D/3
Z10-15M/2	ZS048LIL.....D/2	ZS127.....D/2	ZS30/8RD/4	ZSJR146/1D/16	ZSVRS-D/12-13
Z20.....M/2	ZS048ND/2	ZS127BD/2	ZS381.....D/2	ZSJR146/38D/16	
Z50.....M/2	ZS048P.....D/2	ZS127FEH.....D/2	ZS381BD/2	ZSJR180/05D/16	
ZS016.....D/2	ZS048SD/2	ZS127KD/2	ZS381FEH.....D/2	ZSJR180/1D/16	
ZS016FEH.....D/2	ZS048SZ.....D/2	ZS127LIL.....D/2	ZS381KD/2	ZSJR180/15D/16	
ZS016KD/2	ZS048Z.....D/2	ZS127ND/2	ZS381LIL.....D/2	ZSJR50/05D/16	
ZS016LIL.....D/2	ZS048ZS.....D/2	ZS127P.....D/2	ZS381ND/2	ZSJR50/1D/16	
ZS016P.....D/2	ZS064.....D/2	ZS127SD/2	ZS381P.....D/2	ZSJR50/15D/16	
ZS016SD/2	ZS064BD/2	ZS127SZ.....D/2	ZS381SD/2	ZSJR75/05D/16	
ZS016SZ.....D/2	ZS064FEH.....D/2	ZS127Z.....D/2	ZS381SZ.....D/2	ZSJR75/1D/16	
ZS016Z.....D/2	ZS064KD/2	ZS127ZS.....D/2	ZS381Z.....D/2	ZSJR75/22D/16	
ZS024.....D/2	ZS064LIL.....D/2	ZS140/42RD/4	ZS381ZS.....D/2	ZSRSET-D/6-8	
ZS024BD/2	ZS064ND/2	ZS16/4RD/4	ZS40/12RD/4	ZSRSET3-1,5.....D/5	
ZS024FEH.....D/2	ZS064P.....D/2	ZS175/55RD/4	ZS50.....M/2	ZSRSET3-2,5.....D/5	
ZS024KD/2	ZS064SD/2	ZS19/6RD/4	ZS50/16RD/4	ZSRSET4-D/5	
ZS024LIL.....D/2	ZS064SZ.....D/2	ZS190.....D/2	ZS508.....D/2	ZSRSET5-D/5-6	
ZS024ND/2	ZS064Z.....D/2	ZS190BD/2	ZS508BD/2	ZSSZ0H1,5.....D/18	
ZS024P.....D/2	ZS064ZS.....D/2	ZS190FEH.....D/2	ZS508FEH.....D/2	ZSSZR5D/18	
	ZS095.....D/2	ZS190KD/2	ZS508KD/2	ZSSZVM-1D/18	

Tanúsítvány

Szabvány **ISO 9001:2015**

Tanúsítvány jegyzéksz. 01 100 1824054

Tanúsítvány birtokosa: **TRACON Budapest Kft.**
Pallag utca 23.
2120 Dunakeszi
Magyarország

Alkalmazási terület: **elektromos alkatrészek és szerelési anyagok kis-és nagykereskedelme.**

A tanúsítási audit során bizonyítást nyert, hogy a rendszer megfelel az ISO 9001:2015 követelményeinek.

Érvényesség: **A tanúsítvány érvényes 2018-04-20-tól 2021-04-19-ig.**

2018-04-20

TÜV Rheinland Cert GmbH
Am Grauen Stein · 51105 Köln

www.tuv.com



10201 10.17 E A4 © TÜV, TÜEV and TUV are registered trademarks. Utilization and application requires prior approval.



**Az aktuális tanúsítvány
letölthető honlapunkról!**